

MAY  
2023

# OFFICE FURNITURE

SEATING | DESKING | TABLES | CHAIRS | OFFICE | CAFE | RESTAURANT | WORKPLACE | UNIVERSITY | COMFORT | STYLE | CRAFTSMANSHIP | QUALITY



INCLUDES  
HOMEWORING  
FURNITURE



## Richardsons

Infinite Workplace **Solutions**

The Business Centre, Morley Carr Road,  
Low Moor, Bradford BD12 0RA.

Email: [sales@richardsonsoffice.co.uk](mailto:sales@richardsonsoffice.co.uk)

### 01274 675515

[www.richardsonsoffice.co.uk](http://www.richardsonsoffice.co.uk)





we do healthcare,  
we do education,  
we do corporate,  
we do hospitality

# What can we do for you?



**Richardsons**  
Infinite Workplace Solutions



# CONTENTS

## PRODUCT DIRECTORY 2023

### DESKING

Bench <sup>2</sup> Access Top.....	32
Bench <sup>2</sup> Accessories & Cable Trays.....	46
Bench <sup>2</sup> Fixed Top.....	38
Bench <sup>2</sup> Height Adjustable.....	44
Bench <sup>2</sup> Scallop Top.....	34
Cable Management.....	86
D3K Manual Height Adjustable.....	56
D3K Fully Welded.....	76
Design 2000 Fully Welded.....	78
Deskit.....	68
Electrical Accessories.....	88
EX10 Executive.....	57
Home Worker.....	74
Mesa & Mesa Plus.....	48
Modular Reception Units.....	80
Monitor Arm & Accessories.....	94
Rise.....	60
Rise LT.....	64
Rise Squared.....	66
Script.....	10

### TABLES

Bench <sup>2</sup> .....	138
Betibo.....	NEW 100
D3K.....	140
Deck.....	128
Doc.....	148
EX10 & X10.....	142
GC1.....	152
GC4.....	154
GD1.....	104
GD3.....	179
GD10.....	106
GD10 Cirque.....	NEW 115
GD27.....	180
iMedia.....	136
Laptop & Utility.....	181
LS21.....	118
LS22.....	119
LS23.....	120
LTA.....	166
LTC.....	168
LTD.....	170
LTF.....	172
Moment.....	122
Multi-Purpose.....	162
Occasional.....	165
Plectra.....	147
Reception.....	176
Relo.....	NEW 182
Script.....	146
Stand Height.....	150
Steps.....	116
Swing Out.....	149
Telford Adapt.....	160
Telford Fixed Top.....	158
Telford Folding Leg.....	159
Telford Tilt Top.....	156
Telford Segment.....	161
Vona.....	178

### SCREENS & PODS

Barrier Screens.....	250
Cluster Screens.....	254
Curved Vision Panels.....	256
Free Standing Desktop Screens.....	252
GE6.....	218
GE Acoustics.....	248
GE Mobile Pods.....	216
Glazed Vision Panels.....	251
GOF Desk Mounted Fixing Brackets.....	226
GOF Desk Mounted Linking Posts & Accessories.....	227
GOF Desk Mounted.....	220
GOF Floor Standing Link Posts & Accessories.....	240
GOF Floor Standing.....	228
GOF Goal Post.....	238
GOF Panels.....	236
Kulture Habitat.....	NEW 186
Mesa Plus.....	242
MFC and Acrylic Screens.....	259
Mirage Haze.....	212
Mirage Haze Phone Booth.....	214
Mirage Hutch.....	NEW 192
Mirage Lite.....	243
Mirage Pods.....	194
Mirage Trees.....	NEW 234
Mobile Floor Standing Screens.....	257
Screen Brackets and Accessories.....	253
Static Floor Standing Screens.....	258

### STORAGE

Bookcases & Pigeon Hole Units.....	274
Cabinets & Units.....	269
Kulture Quoll.....	280
Modular.....	276
Modular Credenzas & Mobile Units.....	278
Pedestals.....	262
Pedestals & Storage Units.....	264
Planters.....	284
Steel Units & Lockers.....	285
System Capacity Planning.....	268
System.....	266
Top & Base Units.....	272

### BESPOKE

Case Studies.....	292
Finishes & Additions.....	290
Introduction.....	286
Our Process.....	288

### TASK & VISITOR

Adlington.....	334
Adlington Mesh.....	336
Bromley 24/7.....	338
G Series Fabric.....	318
G Series Mesh.....	319
Harlequin Executive.....	313
Harlequin Mesh.....	331
Industrial.....	340
Keeko.....	312
LS37.....	341
Move Up.....	320
Oscar.....	308
Platinum Ergo.....	326
Platinum Mesh.....	330
Platinum Plus Round.....	322
Platinum Plus Squared.....	324
Platinum Squared.....	328
Santis Ergo.....	332
Santis Squared.....	333
Take Off Executive.....	314
Take Off.....	316
Tamper Proof.....	339
Task Seating Arms.....	306
Task Seating Mechanisms.....	304

### CONFERENCE, MEETING & CAFÉ

Bretten.....	384
Café & Bistro.....	378
Coso.....	366
Garo.....	382
GC5.....	374
GC7.....	372
GD2 Stool.....	368
GD3 Stool.....	370
Heavy Duty.....	418
Hour.....	375
Kast.....	344
Kempton.....	415
LC11 Chrome.....	350
LC11 Gas.....	354
LC11 Sled.....	346
LC11 Star.....	348
LC11 Stool.....	352
LC11 Wood.....	349
LC17 Wood.....	355
LC18 Wood.....	356
LG1.....	363
LG4 Chrome.....	360
LG4 Plastic.....	358
LG4 Wood.....	359
LG27.....	371
LG31.....	376
LG33.....	367
LS36.....	362
Meroux.....	385
Meeting Chair.....	410
Metric Plus.....	412
Metric Plus Executive.....	414
Mod.....	416
Oli.....	392
Onio.....	383
Qus.....	364
SJX.....	394
Theia.....	388
Theia Stool.....	390
Turn.....	420
Visa.....	380
Vona.....	386
Zela.....	402

### SOFT SEATING, RECEPTION & BREAKOUT

Adore.....	452
Alvier Sled Leg.....	466
Alvier Tube Leg.....	468
Alvier Wooden Leg.....	464
Atrium.....	509
Betibo.....	456
Betsy.....	450
Chatte.....	506
Claire.....	505
Cubes & Arrows.....	516
Curves, Ovals & Rectangles.....	520
Gallen.....	460
Hecta.....	444
Izzy.....	470
Izzy Lite.....	472
Klyro High Back.....	428
Klyro Low Back.....	430
Klyro Meeting Chair.....	432
Kulture Capaldi.....	498
LG10.....	457
LG30.....	455
Little Hecta.....	446
LS24.....	496
LS35.....	522
Lynstock Choice Reception.....	513
Masca.....	448
Monoko.....	NEW 424
Moons & Rounds.....	518
Motile.....	454
Nao.....	504
Neos.....	500
Newton.....	519
Opso.....	459
Osana Bench.....	NEW 476
Outwood.....	510
Oxy.....	508
Pennine.....	514
Relo.....	NEW 427
Richmond.....	503
Solent.....	512
Sound Station.....	502
Steps 4 Star Base.....	440
Steps Castor Base.....	442
Steps Sled Base.....	438
Steps Swivel Base.....	434
Steps Swivel Wood Clad Base.....	436
Stratt Plus.....	501
Take Off.....	488
Take Off Lite.....	494
Take Off Plus High Back.....	492
Take Off Plus Low Back.....	490
Take Up.....	484
Take Up Booth.....	484
Tiros.....	NEW 474
Uno Booth.....	NEW 478

### BEAM SEATING

Elsa Beam.....	530
SJX Beam.....	526
Zela Beam.....	528

### TECHNICAL INFORMATION

Beam Seating Specification.....	535
Gallen Dimensions.....	536
Seating Dimensions.....	538
Take Up Booth Dimensions.....	537

### FABRICS & FINISHES

Selected Band Fabrics.....	549
Wood, Metal & Laminate Finishes.....	554

Due to a policy of continuous product improvement & development, we reserve the right to change detail or discontinue products without prior notification. All prices featured are retail and are subject to your agreed contractual/discount structure. VAT is applicable at the current rate. The contents in this brochure is for general information purposes only. Whilst we endeavour to ensure that the information in this brochure is correct, no warranty, express or implied, is given as to its accuracy and we do not accept any liability for error or omission.

# OUR STORY

## PRODUCT DIRECTORY 2023



## WE HAVE BEEN DESIGNING WORK SPACES AND FURNITURE SINCE **1976.**

We employ more than 250 people based at our 200,000sq ft office and factory space in Greater Manchester. Our 'Investors in People' award demonstrates how much we value our workforce. They are expertly skilled to design, produce and install superb workspace furniture. Owned and run by family members, we are proud to be a 'True UK Manufacturer' and share with you the benefits of high quality British goods. As well as clients across the UK, we also export our products internationally.

Since most of us spend many hours each day at work, it is important that we feel both comfortable and happy within that working environment. At Gresham, we consider every aspect of our workspace furniture, through concept and detailed design, prototyping and testing, through to production, assembly and despatch - all backed-up with our dedicated Customer Care team. All of this happens under one roof at our state-of-the-art headquarters in Bolton, with all of our teams working together to ensure we supply the best products and services to you.



Made in Britain brings together the British manufacturing community, united with the use of the registered collective mark. The mark is protected and can only be used by members of Made in Britain that meet the criteria we set to guarantee the member is a British manufacturer.



Gresham is proud to be a member and support the aims and objectives of the trade organisation ACID (Anti Copyright in Design). All of Gresham's designs are supported by ACID through their Copyright & Design Databank and ACID Marketplace.

All intellectual property rights existing in our designs and products (and in the images, text and design of this marketing material) are and will remain the property of Gresham Office Furniture. Any infringement of these rights will be pursued seriously.

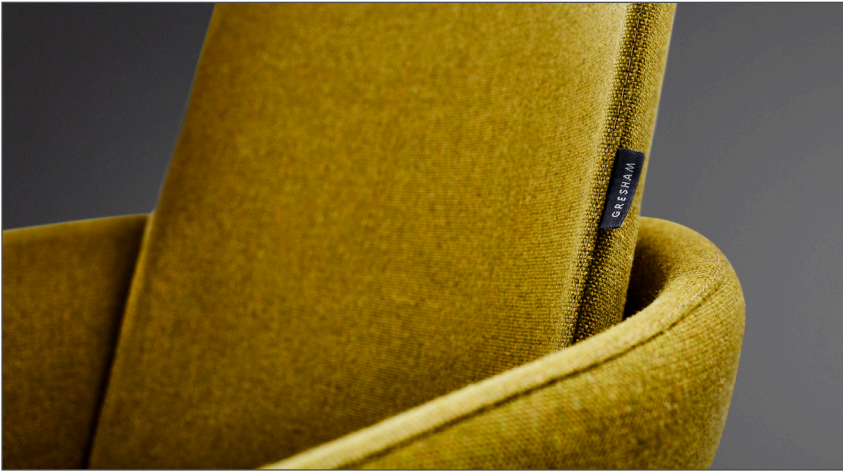

### GRESHAM DESIGN

Gresham works with some of the finest designers to create individual pieces that reflect your personality and enhance your workspace. The company's in-house team boasts experienced designers with backgrounds in Product Design, Industrial and Furniture Design, Design Engineering, Interior Design and Graphics, to name but a few.

Based at our Bolton studio, our team come from a myriad of disciplines, bringing their expertise to create inspiring designs. Whether for mainstream products, special variations or totally bespoke solutions, we provide a complete service from concept through manufacturing to presentation and hand-over. Working in a high-pressure commercial environment, our team needs to balance creativity and flair with quality.

We continually explore innovations in technology, materials and processing, as well as keeping abreast of style, popular colour trends and the ever-adapting workplace. It's all about getting it right.

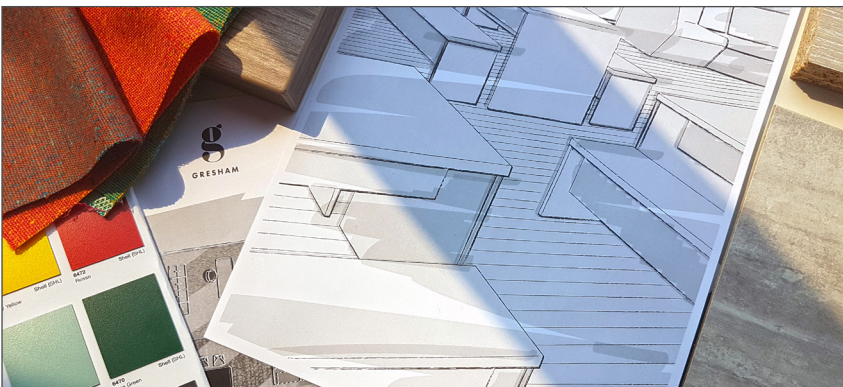

### CAD FILES

**GRESHAM CREATE OUR CAD FILES FOR USE WITHIN AUTOCAD, REVIT, PCON PLANNER, SKETCH UP AND 3DS MAX.**

Gresham support our clients by implementing the BIM approach to all of our projects. BIM (Building Information Modelling) is a collaborative way of working allowing different sectors to work on one central model. This process means that Architects, Specifiers and Planners can work smarter, faster and cheaper by sharing standardised design information.

PCon Planner and SketchUp are 3D CAD software packages that are free to download and can be used for planning. They are fast becoming the industry standard which is why we create our portfolio in this format. We upload all of our models to 'The 3D Warehouse' - the world's biggest resource for free 3D CAD models.



### INSTALLATION

All installations are undertaken by highly trained & experienced staff at times to suit you. All packaging is removed from site and returned to the factory for recycling.



### LOCAL SERVICE

We provide you with peace of mind that you can access products locally from a renowned manufacturer.



### PROJECT MANAGEMENT

We provide total Project Management from initial enquiry through to installation. A single point of contact ensures efficiency and avoids tying up your own valued resources.



### ERGONOMIC TRAINING

We provide on site ergonomic training to make sure users are familiar with our products ensuring correct seating and posture.

# ENVIRONMENT

## PRODUCT DIRECTORY 2023



### FSC® FOREST STEWARDSHIP COUNCIL®

Its purpose is to promote responsible management of the world’s forests through developing standards, a certification system and trademark recognition. The process of tracking a product back to forest is called “Chain-of-Custody (COC) Certification. Through the COC, companies can demonstrate their commitment to the environment and responsible material sourcing.

Over 99% of the Melamine Faced Chipboard used in the manufacture of office and leisure furniture has been sourced from FSC® certified suppliers. The 1% remaining material, although not FSC® is sourced from non-controversial sources. No trees are cut down specifically to produce MFC.



The mark of responsible forestry

### REDUCING CARBON EMISSIONS.

We are committed to reducing our carbon footprint by instigating strategies which will reduce the use of fossil fuels and the amount of greenhouse gases produced by our processes. We continually invest in state of the art equipment to make manufacturing more efficient. We recycle our waste, reducing landfill and continually update our fleet of vehicles to ensure the latest engine technology is employed.



# ACCREDITATIONS & CERTIFICATIONS

## PRODUCT DIRECTORY 2023

All products are designed and manufactured in conformity to the relevant British and European standards.

Gresham Office Furniture's manufacturing process is achieved in line with the following Accreditations and Certifications:



ISO 14001 : 2015

Environmental Management System.  
Initial Registration: May 2001



ISO 45001 : 2018

Health & Safety Management System



Chain of Custody Certification

Initial Certification: December 2004



BS EN ISO 9001 : 2015

Quality Management System - ISO 9001: 2015  
Full Member



BCFA

British Contract Furnishing Association. Full Member



INVESTORS IN PEOPLE

New standard for Training, Commitment, Planning and Communications.  
Achieved March 2001



CONSTRUCTION LINE

UK's largest register for pre-qualified contractors and consultants. Full Member



SAFE CONTRACTOR

Health & Safety Assessment Scheme.



FIRA

Furniture Industry Research Association. Full Member



FISP

Furniture Industry Sustainability Programme. Full Member



GREEN GROWTH

Made in Britain Green Growth Programme



CHAS

Contractors Health and Safety Assessment Scheme. Full member since 2005.

# INTRODUCTION

## DESKING

Desking

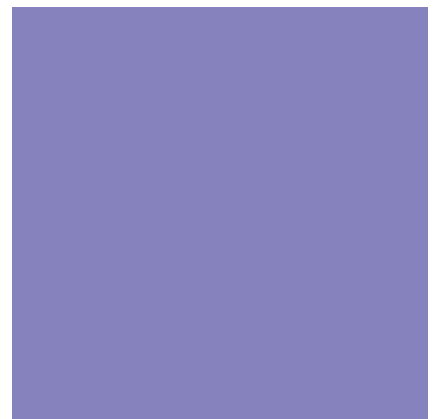
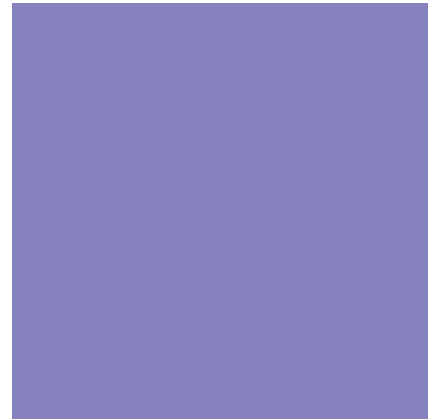
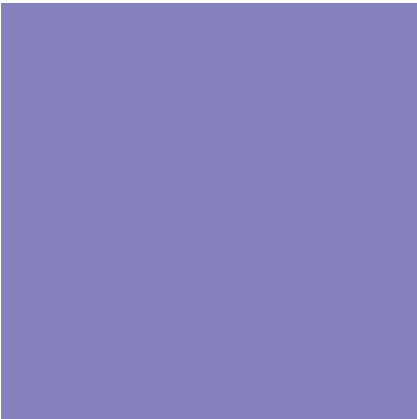
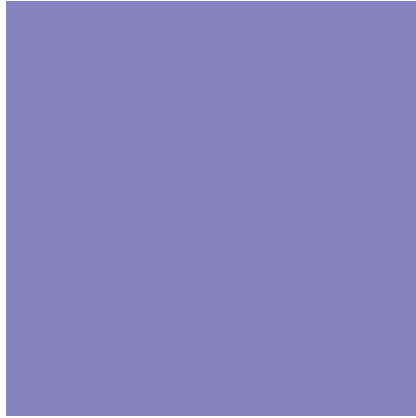





For optional standard pedestals and storage please see Storage section.



For optional cable management please refer to relevant product page or Cable Management in Desking section.



For optional desktop screens please refer to relevant product page or Screens section.



For optional desk accessories please refer to relevant product page or Monitor Arms & Accessories in Desking section.



For optional desk service modules please see Electrical Accessories in Desking section.



For metal finishes please see Technical Information section.

Pastel Paint  
Surcharge = £33 per item.



For board finishes please see Technical Information section.

Adlington Oak  
Surcharge = 15% per item  
Light Concrete  
Surcharge = 15% per item



For Screen fabrics please see Technical Information section.

- All Desking is available in a choice of MFC finishes.
- Unless otherwise stated all Desking is 727mm high with 25mm thick top panels.

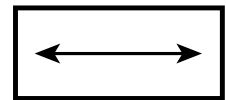

Denotes grain direction

## LEG OPTIONS

Desking is offered in ranges of dimensions to allow you to plan the most convenient size within your work space. Each range is identified by their end frames which, as well as offering visual differences can incorporate features such as height adjustability or cable management.

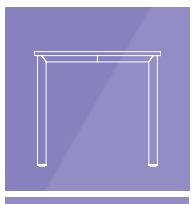

Script  
Straight Leg



Script  
Angled Leg



Bench<sup>2</sup>  
Straight Leg



Bench<sup>2</sup>  
Single Sided  
Angled Leg

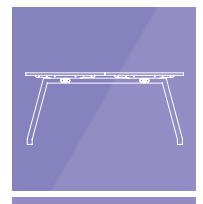

Bench<sup>2</sup>  
Double Sided  
Angled Leg



Rise / Rise Lite  
Straight Leg

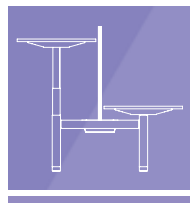

Rise<sup>2</sup>  
Straight Leg

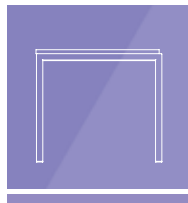

Mesa  
Straight Leg

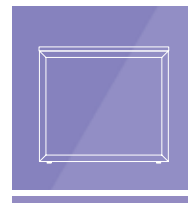

Mesa  
Codi Leg

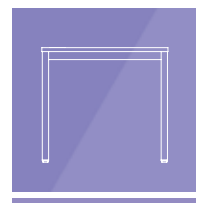

Deskits  
Bench<sup>2</sup>



Deskits  
D3K

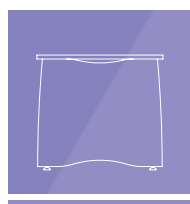

Deskits  
EX10



Deskits  
X10



Deskits  
Design 2000  
Cantilever

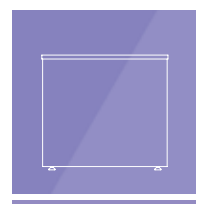

Deskits  
Design 2000  
Panel  
End

# SCRIPT RECTANGULAR DESKING



Desking

- Script is one of our most popular ranges. Clean, simple, striking and seamless.
- Available with Straight or Angled legs.
- 25mm deep Scallop for cable access.



Leg styles

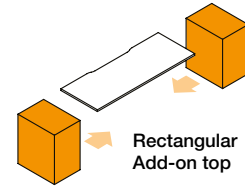
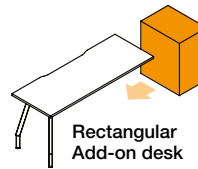
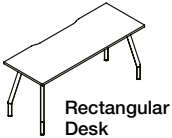
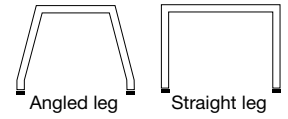

Angled leg Code	Straight leg Code	A	B	MFC Price
<b>Rectangular desk 800mm deep</b>				
XDA188	XDS188	1800	800	£504
XDA168	XDS168	1600	800	£486
XDA148	XDS148	1400	800	£465
XDA128	XDS128	1200	800	£447
XDA108	XDS108	1000	800	£428

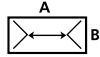

Angled leg Code	Straight leg Code	A	B	MFC Price
<b>Rectangular 800mm deep, Add-on desk packs.</b> Uses 800d Pedestal (not included)				
XDA188A	XDS188A	1800	800	£369
XDA168A	XDS168A	1600	800	£347
XDA148A	XDS148A	1400	800	£330
XDA128A	XDS128A	1200	800	£315
XDA108A	XDS108A	1000	800	£292

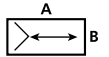

Angled leg Code	Straight leg Code	A	B	MFC Price
<b>Rectangular desk 600mm deep</b>				
XDA186	XDS186	1800	600	£411
XDA166	XDS166	1600	600	£389
XDA146	XDS146	1400	600	£374
XDA126	XDS126	1200	600	£355
XDA106	XDS106	1000	600	£336

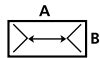

Angled leg Code	Straight leg Code	A	B	MFC Price
<b>Rectangular 600mm deep, Add-on desk packs.</b> Uses 600d Pedestal (not included)				
XDA186A	XDS186A	1800	600	£299
XDA166A	XDS166A	1600	600	£282
XDA146A	XDS146A	1400	600	£262
XDA126A	XDS126A	1200	600	£241
XDA106A	XDS106A	1000	600	£227

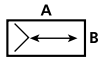

Suffix	Description	Surcharge
H	Desk legs (set of 4)	£76
	Desk legs (set of 2)	£38

All free standing desks can be fitted with Height adjustable legs. Provides 120mm adjustment.



<b>800mm deep Rectangular Add-on Top</b> Uses 800d Pedestal (not included)				
XD188		1800	800	£233
XD168		1600	800	£213
XD148		1400	800	£195
XD128		1200	800	£178

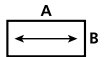

<b>600mm deep Rectangular Add-on Top</b> Uses 600d Pedestal (not included)				
XD186		1800	600	£194
XD166		1600	600	£172
XD146		1400	600	£155
XD126		1200	600	£138

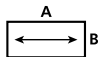

10 Year  
Guarantee

# SCRIPT RECTANGULAR DESKING

Desking

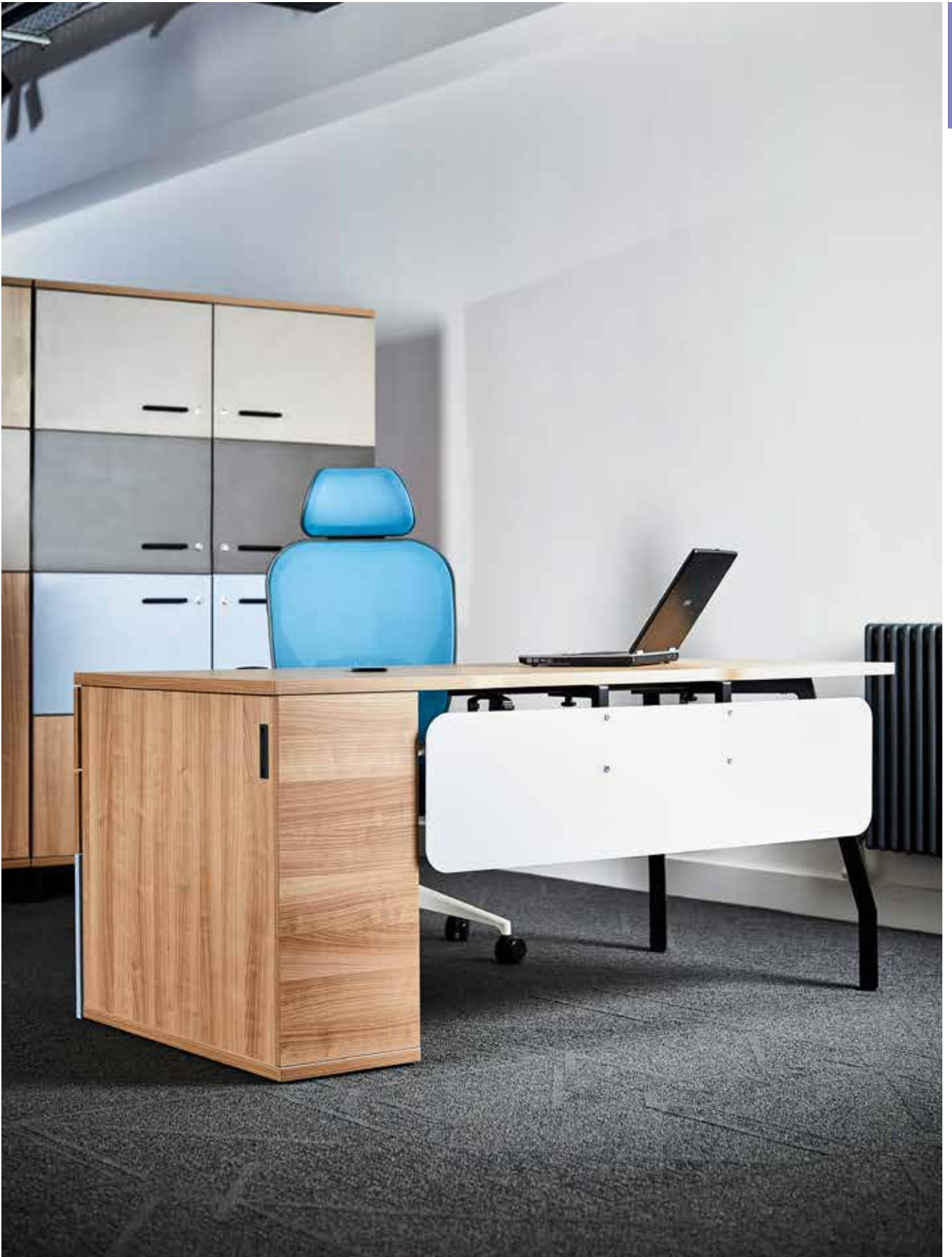

Rectangular Add-on Desk and Structural Standard Drawer Pedestal

# SCRIPT RETURN UNITS DESKING



Desking

Return units fit to the front edge of rectangular and angled wave desks (deeper end).

- Used to create right-angled workstations.
- Can fit to left or right hand sides.
- Fly-over top pedestals work the same way.



Leg styles

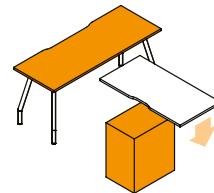
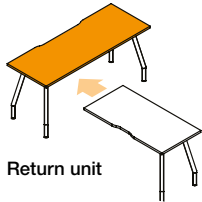
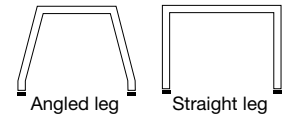

**600mm deep Fly over Top - unhanded**  
Fits to front edge of workstation to form return unit.

Angled leg Code	Straight leg Code	A	B	MFC Price
-----------------	-------------------	---	---	-----------

**Return desks**  
Main desk not included

XDRU126	XDRUS126	1200 x 600	£223
XDRU106	XDRUS106	1000 x 600	£214
XDRU086	XDRUS086	800 x 600	£212



**Fly over top**  
600mm deep - unhanded uses 600d Pedestals.  
Fits to front edge of workstation to form return. Pedestal not included.

Code	A	B	MFC Price
XFT12	1200 x 600	£140	
XFT10	1000 x 600	£123	
XFT08	800 x 600	£109	

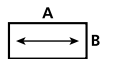

Suffix	Description	Surcharge
H	Desk legs (set of 2)	£38

All free standing desks can be fitted with Height adjustable legs. Provides 120mm adjustment.



10 Year  
Guarantee

# SCRIPT RETURN UNITS DESKING

Desking

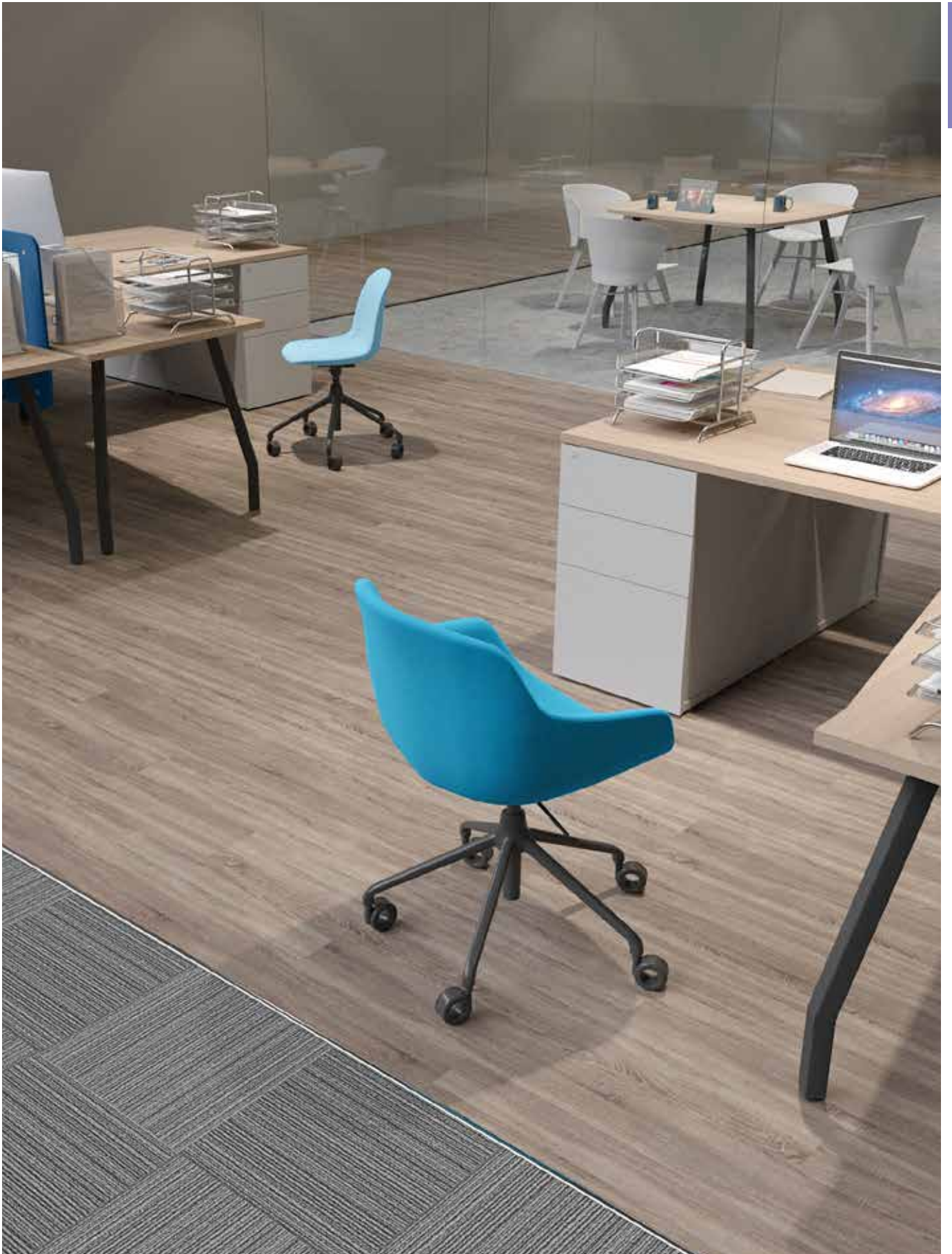

Angled Wave Desks and Fly Over Tops with Structural Standard Drawer Pedestals

# SCRIPT ANGLED WAVE DESKING



Desking

Angled Wave desks function similarly to rectangular desks



- Users face one particular corner.
- Supplied in left or right hand variants.
- Can accept structural pedestals at 800mm end.

Leg styles

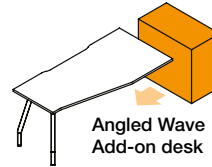
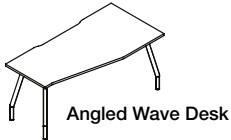
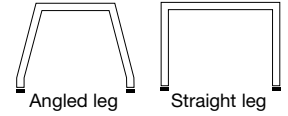

Angled leg Code	Straight leg Code	A	B	C	MFC Price
<b>Angled Wave 1000 to 800mm deep - Right hand</b>					
XWRA1810	XWRS1810	1800	800	1000	£526
XWRA1610	XWRS1610	1600	800	1000	£507
XWRA1410	XWRS1410	1400	800	1000	£489
XWRA1210	XWRS1210	1200	800	1000	£469
<b>Angled Wave 1000 to 800mm deep - Left hand</b>					
XWLA1810	XWLS1810	1800	800	1000	£526
XWLA1610	XWLS1610	1600	800	1000	£507
XWLA1410	XWLS1410	1400	800	1000	£489
XWLA1210	XWLS1210	1200	800	1000	£469
<b>Angled Wave 800 to 600mm deep - Right hand</b>					
XWRA1808	XWRS1808	1800	600	800	£469
XWRA1608	XWRS1608	1600	600	800	£451
XWRA1408	XWRS1408	1400	600	800	£432
XWRA1208	XWRS1208	1200	600	800	£413
<b>Angled Wave 800 to 600mm deep - Left hand</b>					
XWLA1808	XWLS1808	1800	600	800	£469
XWLA1608	XWLS1608	1600	600	800	£451
XWLA1408	XWLS1408	1400	600	800	£432
XWLA1208	XWLS1208	1200	600	800	£413

Angled leg Code	Straight leg Code	A	B	C	MFC Price
<b>Angled Wave 800 to 600mm deep, Right hand Add-on desk packs.</b> Uses 800d pedestal (not included)					
XWRA1808A	XWRS1808A	1800	600	800	£335
XWRA1608A	XWRS1608A	1600	600	800	£318
XWRA1408A	XWRS1408A	1400	600	800	£297
XWRA1208A	XWRS1208A	1200	600	800	£277
<b>Angled Wave 800 to 600mm deep, Left hand Add-on desk packs.</b> Uses 800d pedestal (not included)					
XWLA1808A	XWLS1808A	1800	600	800	£335
XWLA1608A	XWLS1608A	1600	600	800	£318
XWLA1408A	XWLS1408A	1400	600	800	£297
XWLA1208A	XWLS1208A	1200	600	800	£277

Suffix	Description	Surcharge
H	Desk legs (set of 4)	£76
	Desk legs (set of 2)	£38



All free standing desks can be fitted with Height adjustable legs. Provides 120mm adjustment.

10 Year  
Guarantee

# SCRIPT ANGLED WAVE DESKING

Desking



Angled Wave Desk

# SCRIPT CURVED WAVE DESKING



Desking

Curved wave desks function similarly to rectangular desks.

- Users face one particular corner.
- Supplied in left or right hand variants.
- Can accept structural pedestals at narrower end.



Leg styles

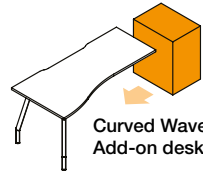
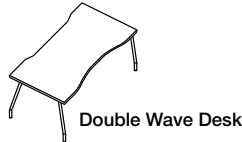
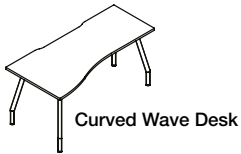
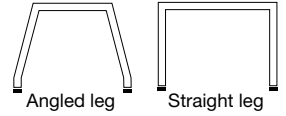

Angled leg Code	Straight leg Code	A	B	C	MFC Price
<b>Curved Wave 1000 to 800mm deep - Right hand</b>					
XEWRA1810	XEWSR1810	1800	800	1000	£526
XEWRA1610	XEWSR1610	1600	800	1000	£507
XEWRA1410	XEWSR1410	1400	800	1000	£489
XEWRA1210	XEWSR1210	1200	800	1000	£469
<b>Curved Wave 1000 to 800mm deep - Left hand</b>					
XEWLA1810	XEWLS1810	1800	800	1000	£526
XEWLA1610	XEWLS1610	1600	800	1000	£507
XEWLA1410	XEWLS1410	1400	800	1000	£489
XEWLA1210	XEWLS1210	1200	800	1000	£469
<b>Curved Wave 800 to 600mm deep - Right hand</b>					
XEWRA1808	XEWSR1808	1800	600	800	£469
XEWRA1608	XEWSR1608	1600	600	800	£451
XEWRA1408	XEWSR1408	1400	600	800	£432
XEWRA1208	XEWSR1208	1200	600	800	£413
<b>Curved Wave 800 to 600mm deep - Left hand</b>					
XEWLA1808	XEWLS1808	1800	600	800	£469
XEWLA1608	XEWLS1608	1600	600	800	£451
XEWLA1408	XEWLS1408	1400	600	800	£432
XEWLA1208	XEWLS1208	1200	600	800	£413
<b>Double Wave 800 to 700mm deep</b>					
XWDA1808	XWDS1808	1800	700	800	£507
XWDA1608	XWDS1608	1600	700	800	£489

Angled leg Code	Straight leg Code	A	B	C	MFC Price
<b>Curved Wave 1000 to 800mm deep, Right hand Add-on desk packs</b> Uses 800d pedestal (not included)					
XEWRA1810A	XEWSR1810A	1800	800	1000	£388
XEWRA1610A	XEWSR1610A	1600	800	1000	£372
XEWRA1410A	XEWSR1410A	1400	800	1000	£352
XEWRA1210A	XEWSR1210A	1200	800	1000	£335
<b>Curved Wave 1000 to 800mm deep, Left hand Add-on desk packs</b> Uses 800d pedestal (not included)					
XEWLA1810A	XEWLS1810A	1800	800	1000	£388
XEWLA1610A	XEWLS1610A	1600	800	1000	£372
XEWLA1410A	XEWLS1410A	1400	800	1000	£352
XEWLA1210A	XEWLS1210A	1200	800	1000	£335
<b>Curved Wave 800 to 600mm deep, Right hand Add-on desk packs</b> Uses 600d pedestal (not included)					
XEWRA1808A	XEWSR1808A	1800	600	800	£362
XEWRA1608A	XEWSR1608A	1600	600	800	£342
XEWRA1408A	XEWSR1408A	1400	600	800	£319
XEWRA1208A	XEWSR1208A	1200	600	800	£304
<b>Curved Wave 800 to 600mm deep, Left hand Add-on desk packs</b> Uses 600d pedestal (not included)					
XEWLA1808A	XEWLS1808A	1800	600	800	£362
XEWLA1608A	XEWLS1608A	1600	600	800	£342
XEWLA1408A	XEWLS1408A	1400	600	800	£319
XEWLA1208A	XEWLS1208A	1200	600	800	£304



10 Year  
Guarantee

# SCRIPT CURVED WAVE DESKING

Desking



Curved Wave Desks & Structural Steel Drawer Pedestals

# SCRIPT 120° WORKSTATION DESKING

10 Year  
Guarantee

Deskings

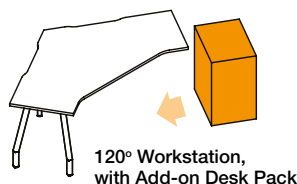
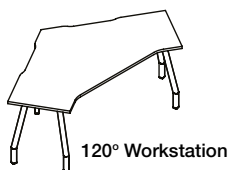

Leg Styles

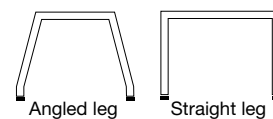

Angled leg Code	Straight leg Code	A	B	C	D	MFC Price	Angled leg Code	Straight leg Code	A	B	C	D	MFC Price
<b>120° Workstation</b>							<b>120° Workstation, Add-on Desk Packs</b> Pedestal Not Included						
XDY128	XDYS128	1200	800	800	1200		£818	XDY128A	XDYS128A	1200	800	800	
XDY126	XDYS126	1200	600	600	1200	£721	XDY126A	XDYS126A	1200	600	600	1200	£608

Suffix	Description	Surcharge
H	Desk legs (set of 6)	£114

All free standing desks can be fitted with Height adjustable legs. Provides 120mm adjustment.



## Conference Ends

Angled leg Code	Straight leg Code	Description	A	B	MFC Price
XSCT16	XSSCT16	Semi-Circular	1640	820	£363
XSCT12	XSSCT12	Semi-Circular	1240	620	£330
XSET16	XSSET16	Semi-Elliptical	1640	600	£336
XSET12	XSSET12	Semi-Elliptical	1240	450	£306



Semi - Circular Conference End shown with Add-on Desk and Drop Height Storage

10 Year  
Guarantee

# SCRIPT 120° WORKSTATION DESKING

Desking



120° Workstation

# SCRIPT STRUCTURAL PEDESTALS DESKING

10 Year  
Guarantee

Desking

Structural Pedestals can be used to replace leg frames.

- Used with Add-on desks or Add-on Tops.
- Cost effective solution.
- Can be shared between two workspaces.
- 800 deep to suit 800 deep Add-on desks or Add-on Tops.
- 600 deep to suit 600 deep Add-on desks or Add-on Tops.

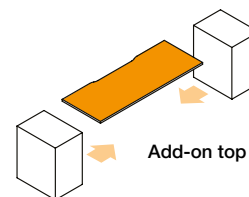
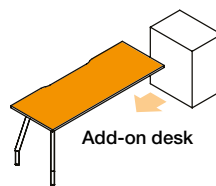

Code	W	D	MFC Price
<b>430mm width - 2 shallow &amp; 1 Filing Drawer</b>			
Replaces single fixed height leg as support on Add-on units			
3XFP8	430	x 800	£432
3XFP6	430	x 600	£407
<b>300mm width - 2 shallow &amp; 1 Filing Drawer</b>			
Replaces single fixed height leg as support on Add-on units			
3XSFP8	300	x 800	£432
3XSFP6	300	x 600	£407
<b>Pen tray -</b>			
For use in standard drawer units			
EPT			£21



Code	Description	W	D	MFC Price
<b>Structural Hinged Door Storage with Single Shelf</b>				
Available in all MFC wood finishes. White can have white or wood grained door - must be specified.				
XHPRW83	Right hand	300	x 800	£346
XHPRW63	Right hand	300	x 600	£330
XHPLW83	Left hand	300	x 800	£346
XHPLW63	Left hand	300	x 600	£330
<b>Structural Hinged Door Storage with Single Shelf</b>				
Available in all MFC wood finishes. Frosted Opal Acrylic Door.				
XHPRA83	Right hand	300	x 800	£508
XHPRA63	Right hand	300	x 600	£484
XHPLA83	Left hand	300	x 800	£508
XHPLA63	Left hand	300	x 600	£484



Rectangular Add-on tops & Structural Slim Line Steel Drawer Pedestals

# SCRIPT STRUCTURAL SHELVING DESKING

Structural Storage can be used to replace leg frames.

- Used with Add-on desks or Add-on Tops.
- Cost effective solution.
- Available open fronted or with sliding door options.

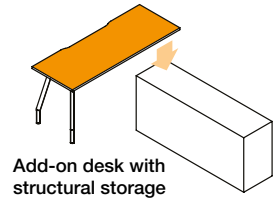
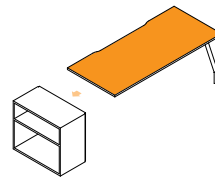

Add-on desk with structural storage

Code	To fit	MFC Price
<b>800 &amp; 600 x 434mm Open fronted unit</b>		
Replaces single leg as support unit - Can face both ways		
XSUB08	800 deep	£212
XSUB06	600 deep	£198

Code	To fit	MFC Price
<b>1600 x 434mm Open fronted unit</b>		
Replaces single leg as support unit - Can face both ways		
XSUB168	800 deep	£384
XSUB166	600 deep	£384

Code	To fit	MFC Price
<b>1600 x 434mm Open fronted unit with full width top (can be used as standalone)</b>		
XSUB16		£455

Code	To fit	MFC Price
<b>1600 x 434mm Single wooden sliding door</b>		
Replaces single leg as support unit - Can face both ways		
XSWD168	800 deep	£542
XSWD166	600 deep	£542

Code	To fit	MFC Price
<b>1600 x 434mm Single wooden sliding door full width top (can be used as standalone)</b>		
XSWD16		£613

Code	To fit	MFC Price
<b>800 &amp; 600 x 320mm Slimline Open fronted unit</b>		
Replaces single leg as support unit - Can face both ways		
XSUBS08	800 deep	£212
XSUBS06	600 deep	£198

Code	To fit	MFC Price
<b>1600 x 320mm Slimline Open fronted unit</b>		
Replaces single leg as support unit - Can face both ways		
XSUBS168	800 deep	£384
XSUBS166	600 deep	£384

Code	To fit	MFC Price
<b>1600 x 320mm Slimline Open fronted unit with full width top (can be used as standalone)</b>		
XSUBS16		£455

Code	To fit	MFC Price
<b>1600 x 320mm Slimline Single wooden sliding door</b>		
Replaces single leg as support unit - Can face both ways		
XSWDS168	800 deep	£542
XSWDS166	600 deep	£542

Code	To fit	MFC Price
<b>1600 x 320mm Slimline Single wooden sliding door full width top (can be used as standalone)</b>		
XSWDS16		£613

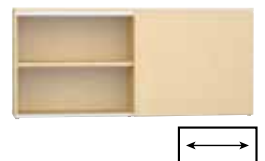
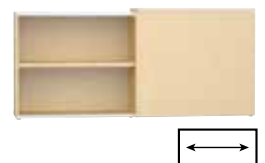
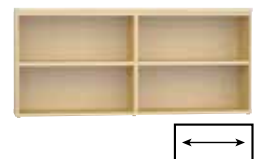
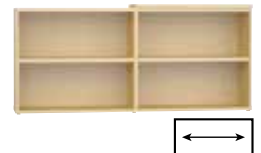
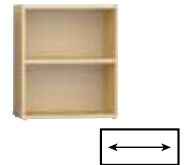

# SCRIPT OVER DESK STORAGE DESKING

10 Year  
Guarantee

Desking

Over Desk Storage file hutches for workspaces.

- Can fit to the rear or side of units.
- Can fit to top of desks or storage units.
- Can be retro-fitted.



Code      W      D      H      MFC Price

### Open Fronted Desk File Hutch

Fits to all standard desk models and can be retro fitted



XFH16	1584	x	334	x	375	£253
XFH10	1000	x	334	x	375	£195
XFH08	800	x	334	x	375	£178
XFH06	600	x	334	x	375	£171



1000mm, 800mm & 600mm



1584mm

Examples of  
configuration

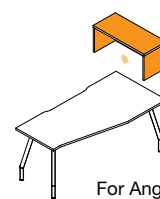
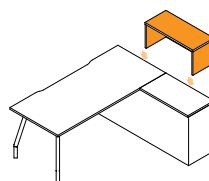
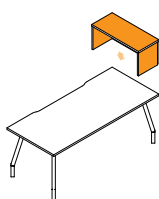
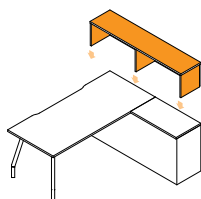

For Angled Wave



Rectangular Add-on desk with Structural Storage & File Hutch



Cable Baskets offer simple cable control under desk worksurfaces.

- Can be retro-fitted.
- Baskets can be positioned in a choice of two heights.
- Baskets are offered in a selection of colours to match legs.

**Basket can fit on suspension brackets in two positions:**

1. To accommodate tall under desk pedestals under tray.
2. To accommodate transformer plugs in basket. Basket can be unhooked from suspension brackets on one side to provide easy access to cables and modules.

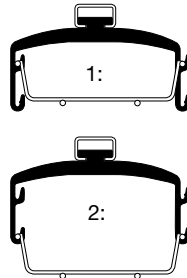

Cable Baskets can be used in a non-modular way i.e. smaller baskets can be fitted where required on a larger desks, e.g. 800 Cable Basket can be fitted on to 1600 Desk.



Horizontal Cable Basket - available in Black, Grey, Silver or White. Fits to under desk service rail or suspension brackets can be screwed directly to the underside of the work surface.

Code	Basket length	Top size	Price	Cable Basket positions
MECT16	1426	1800	£86	
MECT14	1222	1600	£85	
MECT12	1019	1400	£79	
MECT10	816	1200	£76	
MECT08	612	1000	£74	
MECT06	410	800	£70	
MECT12	1019	1800	£79	
MECT10	816	1600	£76	
MECT08	612	1400	£74	
MECT06	410	1200	£70	
MECT10	816	1800	£76	
MECT08	612	1600	£74	
MECT06	410	1400	£70	

Structural pedestals have cable pass through to the rear

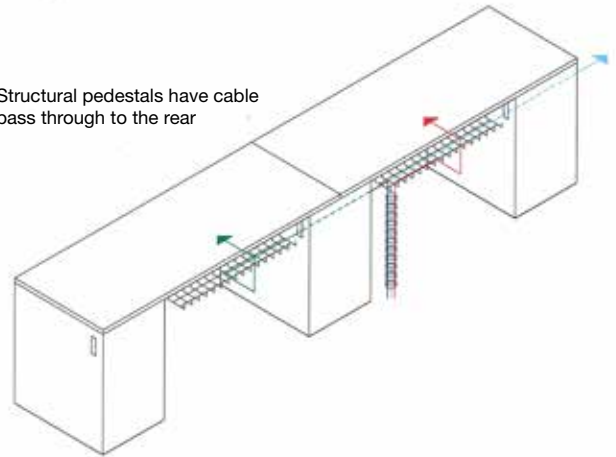

Drop height structural units allow continuous cable management throughout clustered desks.

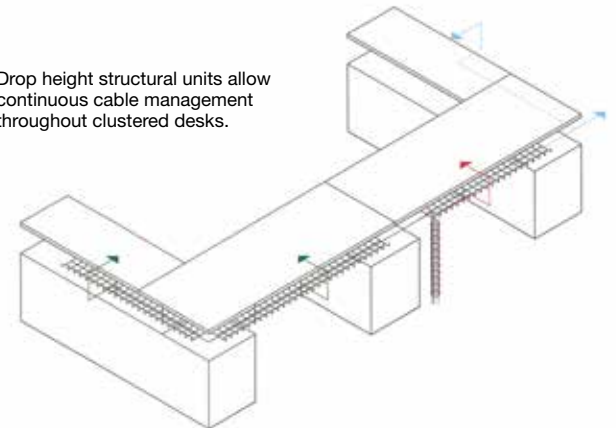

**Return Side Service Rail Pack**  
Used to suspend cable trays, divider screens on desk ends and return side of desk.



XSRR Fits to 600, 800 & 1000 Sides £33

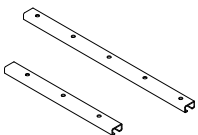

# SCRIPT MODESTY PANELS DESKING

10 Year  
Guarantee

Desking

Modesty panels can be fitted to individual Script desks to cover the knee space of the user.

- Optional – need only be specified where required.
- Available in Wooden MFC and Frosted Opal Acrylic.
- Can be fitted in a variety of positions to suit user needs.



Wooden MFC Code	Acrylic Code	Top Size	Wooden MFC Price	Acrylic Price
XCPW18	XCPA18	1800	£147	£291
XCPW16	XCPA16	1600	£108	£273
XCPW14	XCPA14	1400	£107	£256
XCPW12	XCPA12	1200	£104	£179
XCPW10	XCPA10	1000	£89	£145
XCPW08	XCPA08	800	£77	£107
XCPW06	XCPA06	600	£69	£74

Suspended modesty panel positions

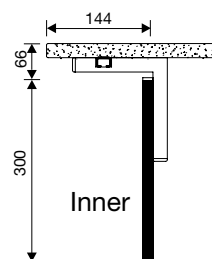

XCPW14	XCPA14	1800	£107	£256
XCPW12	XCPA12	1600	£104	£179
XCPW10	XCPA10	1400	£89	£145
XCPW08	XCPA08	1200	£77	£107
XCPW06	XCPA06	1000	£69	£74

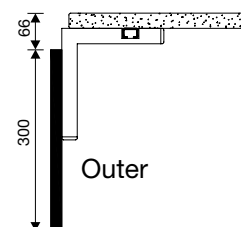
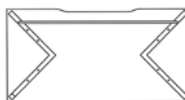

XCPW10	XCPA10	1800	£89	£145
XCPW08	XCPA08	1600	£77	£107
XCPW06	XCPA06	1400	£69	£74

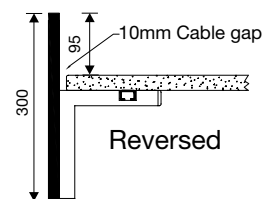

XCPW08	XCPA08	1800	£77	£107
XCPW06	XCPA06	1600	£69	£74

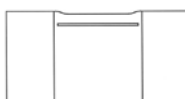

Opal Acrylic Modesty Panel (Inner) & Cable Basket



Desk Mounted Screens can be fitted to individual or clustered desks.

- Offers user privacy.
- Delineate personal space.
- Desk mounted screens available in Wooden MFC, Frosted Opal Acrylic and Fabric.
- Full height screens available in MFC.

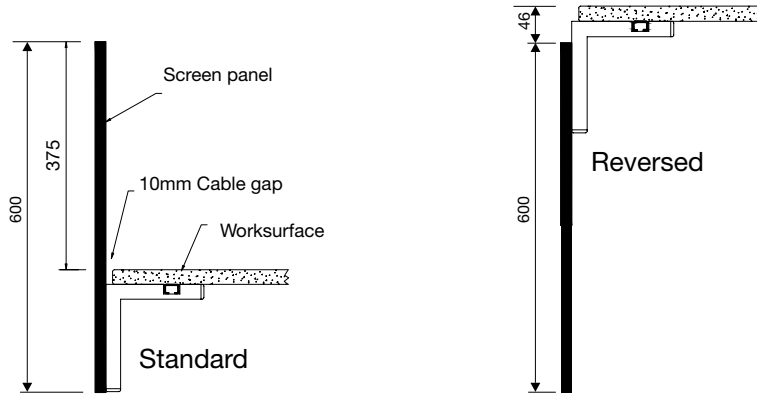

Code	W	H	Band 1 Price	Band 2 Price	Band 3 Price
<b>Fabric screens - 600 high 375 above desk</b>					
XSDF184	1790 x	600	£273	£312	£372
XSDF164	1590 x	600	£262	£289	£348
XSDF144	1390 x	600	£211	£239	£297
XSDF124	1190 x	600	£201	£230	£273
XSDF104	990 x	600	£176	£201	£246
XSDF084	790 x	600	£166	£185	£212
XSDF064	590 x	600	£146	£176	£198

Code	W	H	Price
<b>Frosted Opal Acrylic screens - 600 high 375 above desk</b>			
XSDA184	1790 x	600	£455
XSDA164	1590 x	600	£451
XSDA144	1390 x	600	£446
XSDA124	1190 x	600	£440
XSDA104	990 x	600	£274
XSDA084	790 x	600	£236
XSDA064	590 x	600	£201

<b>*MFC screens - 600 high 375 above desk</b>			
XSDW184	1790 x	600	£169
XSDW164	1590 x	600	£162
XSDW144	1390 x	600	£150
XSDW124	1190 x	600	£140
XSDW104	990 x	600	£126
XSDW084	790 x	600	£118
XSDW064	590 x	600	£108

<b>*M.F.C - Full height 375 above desk</b>			
XSDW1811	1790 x	1110	£357
XSDW1611	1590 x	1110	£338
XSDW1411	1390 x	1110	£318
XSDW1211	1190 x	1110	£293
XSDW1011	990 x	1110	£272
XSDW0811	790 x	1110	£252
XSDW0611	590 x	1110	£229

\*Available in all finishes including Accent colours

Code	Description	Price
<b>Magnetic Name Plate/Label Holder - to fit MFC Screens only</b>		
XSRLH	100mm wide (pack of 5). Supplied with acetate cover strips. Items stick to magnetic board below.	£34
<b>Magnetic Board - to fit MFC Screens only</b>		
XSDNP	230w x 320d magnetic board Can be used with magnetic holders and name plate / label holder. Metalwork colour must be specified.	£67
<b>Fabric Pin Board - to fit MFC Screens only</b>		
XSFP08	800 x 300 high fabric pin board	£112
XSFP06	600 x 300 high fabric pin board Band 1 screen fabric. Metalwork colour must be specified.	£100
<b>A4 Tray - to fit MFC Screens only</b>		
XSATRAY	A4 tray Metalwork colour must be specified.	£69
<b>Stationery Tray - to fit MFC Screens only</b>		
XSSTRAY	Stationery tray Metalwork colour must be specified.	£69
<b>Phone Dock - to fit MFC Screens only</b>		
XSPD	Holds mobile phone to screen Metalwork colour must be specified.	£62
<b>Tablet Dock - to fit MFC Screens only</b>		
XSPDI	Holds tablet to screen Metalwork colour must be specified.	£62
<b>Screen Rail Pen Tray - to fit MFC Screens only</b>		
XSPPP	Screen rail pencil slot Metalwork colour must be specified.	£69

# SCRIPT SYSTEM DESKING

10 Year  
Guarantee

Desking

- Script products are designed for clean-lined aesthetics and ease of use.
- Steel drawers are used for added functionality and strength.
- 600mm deep runners have 3/4 extension. 800mm deep runners have full extension on bottom drawer.
- Filing frames sold separately.

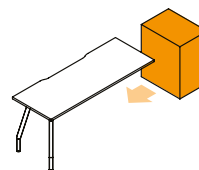

Code	W	D	MFC Price
------	---	---	-----------

#### 443mm width - Single drawer

Replaces single fixed height leg as support on Add-on units

1XFPT8	443	x 800	£600
1XFPT6	443	x 600	£540



Code	W	D	MFC Price
------	---	---	-----------

#### 343mm width - 2 deep drawers\*

Replaces single fixed height leg as support on Add-on units

2XSFPT8	343	x 800	£545
2XSFPT6	343	x 600	£444



#### 443mm width - 2 deep drawers\*

Replaces single fixed height leg as support on Add-on units

2XFPT8	443	x 800	£545
2XFPT6	443	x 600	£444



#### 343mm width - 2 shallow & 1 deep drawer\*

Replaces single fixed height leg as support on Add-on units

3XSFPT8	343	x 800	£635
3XSFPT6	343	x 600	£526



#### 443mm width - 2 shallow & 1 deep drawer\*

Replaces single fixed height leg as support on Add-on units

3XFPT8	443	x 800	£635
3XFPT6	443	x 600	£526



#### 343mm width - 4 shallow drawers

Replaces single fixed height leg as support on Add-on units

4XSFPT8	343	x 800	£669
4XSFPT6	343	x 600	£606



#### 443mm width - 4 shallow drawers

Replaces single fixed height leg as support on Add-on units

4XFPT8	443	x 800	£669
4XFPT6	443	x 600	£606



\*can accept filing frame. Filing frame sold separately.

10 Year  
Guarantee

# SCRIPT SYSTEM DESKING

Desking

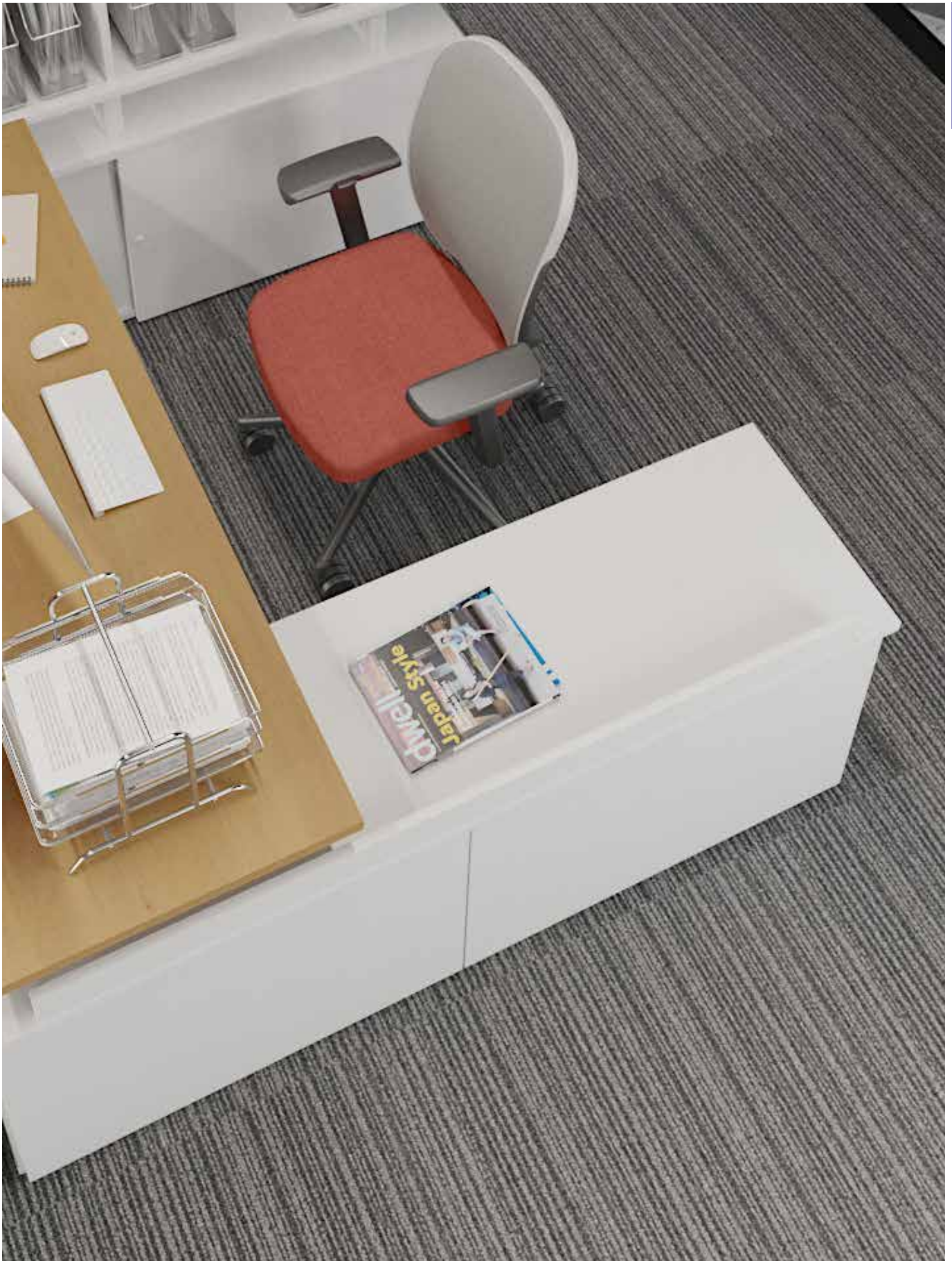

Rectangular Add-on Tops with Drop Height & Overhead Storage

# SCRIPT SYSTEM DESKING



Desking

- Drop Height Pedestal creates pass through zone for electrics.
- Script pedestals have finger-pull drawer fronts and Steel System Drawers.
- Finished height including offset bracket 702mm.

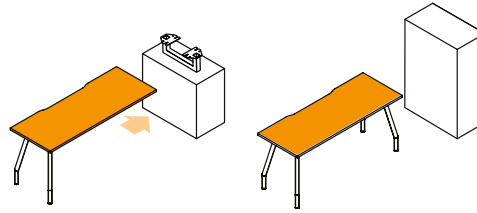

Code      W      D      MFC Price

**443mm width - 1 shallow drawer & 1 deep drawer\***  
Replaces single fixed height leg as support on Add-on units. Supplied with desk offset bracket.

2XFPTD8	443 x	800	£554
2XFPTD6	443 x	600	£500



**443mm width - 3 shallow drawers**

Replaces single fixed height leg as support on Add-on units. Supplied with desk offset bracket.

3XPTD8	443 x	800	£637
3XPTD6	443 x	600	£584



**343mm width - 1 shallow drawer & 1 deep drawer\***  
Replaces single fixed height leg as support on Add-on units. Supplied with desk offset bracket.

2XSFPD8	343 x	800	£554
2XSFPD6	343 x	600	£500



**343mm width - 3 shallow drawers**

Replaces single fixed height leg as support on Add-on units. Supplied with desk offset bracket.

3XSPTD8	343 x	800	£637
3XSPTD6	343 x	600	£584



**Single Drawer Tower Pedestal - 1110h x 443w**  
Sits adjacent or between desks

1XTOW8	443 x	800	£829
1XTOW6	443 x	600	£751

## Script Steel Drawer Pedestal Accessories

Code      Description      Price

### Pen Trays

SLPT04	416 retro fit pull out pen tray	£92
SLPT03	316 retro fit pull out pen tray	£92



TPT	Drop in pen tray fits slimline & full width	£23
-----	---	-----



### Filing Frames

PEDFF84	800 deep x 416 wide	£39
PEDFF64	600 deep x 416 wide	£33
PEDFF83	800 deep x 316 wide	£39
PEDFF63	600 deep x 316 wide	£33



### Drawer dividers

416DIV	416 divider for shallow drawer	£6
A4DIV	A4 partition	£6
A5DIV	A5 partition	£6
A6DIV	A6 partition	£6
A7DIV	A7 partition	£6

\*can accept filing frame. Filing frame sold separately.



Rectangular Add-on Top and Add-on Desk with Drop Height Storage and Pedestal

- Creates cable pass-through zone
- Finished height including offset bracket 702mm.

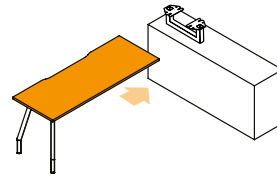

Code To fit MFC Price

### Drop height Open fronted units

Replaces single fixed height leg as support on Add-on units. Supplied with offset bracket.



XDUB10	1000 deep	£429
XDUB08	800 deep	£371
XDUB06	600 deep	£328

### 1600mm x 434mm Drop height Open to upper and lower section

Supplied with desk offset bracket.



XDUBOF1610	1000 deep	£654
XDUBOF1608	800 deep	£648
XDUBOF1606	600 deep	£643

### 1600mm x 434mm Drop height Open to upper section, drawers to lower - locking

Supplied with desk offset bracket.



XDUBDR1610	1000 deep	£1,640
XDUBDR1608	800 deep	£1,634
XDUBDR1606	600 deep	£1,629

### 1600mm 434mm Drop height Full height hinged doors - locking

Supplied with offset bracket.



XDUBHD1610	1000 deep	£902
XDUBHD1608	800 deep	£897
XDUBHD1606	600 deep	£893

### 1600mm x 434mm double sliding wooden door - locking

Supplied with desk offset bracket.



XDUBS1610	1000 deep	£920
XDUBS1608	800 deep	£911
XDUBS1606	600 deep	£908

### 1600mm x 434mm single sliding wooden door - locking

Supplied with desk offset bracket



XDUBWS1610	1000 deep	£880
XDUBWS1608	800 deep	£874
XDUBWS1606	600 deep	£862

### Structural Drop Height Accessories

Rear upstand, Infill top panels, Upholstered seat cushion & Pen tray.

Code Description MFC Price

#### Rear Upstand

XRU16	Fits to 1600 wide top	£33
-------	-----------------------	-----



#### Infill top panels -

Used with drop height units to create continuous worksurface.

XIT10	1600 x 434 infill top to fit 1000 top	£378
XIT08	1600 x 434 infill top to fit 800 top	£371
XIT06	1600 x 434 infill top to fit 600 top	£368



#### Upholstered seat cushion -

Fits to top of unit to provide perching area.

XUSC06	600 x 430 cushion to drop height top	£119
Band 1		£135
Band 2		£160
Band 3		£179
Band 4		£206
Band 5		£227
Band 6		£247
Band 7		



Price

#### Pull out pen tray -

Can be fitted to open sections of storage.

SLPT	Can be retro fitted (screw-on)	£57
------	--------------------------------	-----



# SCRIPT SYSTEM DESKING

10 Year  
Guarantee

Desking

**Code**                      **To fit**                      **MFC Price**

**1600mm x 434mm drop height file drawer / Wooden sliding door combo - locking**  
Supplied with desk offset bracket, Drawer is lockable



Right hand unit shown



**Right hand units**

XDUF1610WR	1000 deep	£1,100
XDUF1608WR	800 deep	£1,092
XDUF1606WR	600 deep	£1,087

**Left hand units**

XDUF1610WL	1000 deep	£1,100
XDUF1608WL	800 deep	£1,092
XDUF1606WL	600 deep	£1,087



Rectangular Add-on Top & Structural Storage



# BENCH<sup>2</sup> ACCESS TOP DESKING

10 Year  
Guarantee

Deskings



## Access Top

- Sliding top for cable tray access.
- Includes cable tray. Please specify bracket depth (increased or standard depth).
- Screens fitted independent of top.
- Accessories i.e. Monitor Arms and Power Modules clamp to rear.
- Can share end frame on back to back and side to side units resulting in cost effective solutions.

Angled leg not available on double sided add-on units.



## Leg styles

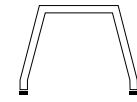

Angled leg prefix code with A

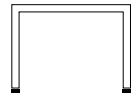

Straight leg

Starter Unit Code	MFC Price	Add-on unit Code	MFC Price	A	B
-------------------	-----------	------------------	-----------	---	---

### Rectangular Desk 800mm deep

Intermediate end frames not available on single sided units.



BA2008Z	£817	BA2008AZ	£710	2000 x 800
BA1808Z	£804	BA1808AZ	£697	1800 x 800
BA1608Z	£792	BA1608AZ	£689	1600 x 800
BA1408Z	£784	BA1408AZ	£674	1400 x 800
BA1208Z	£756	BA1208AZ	£643	1200 x 800
BA1008Z	£732	BA1008AZ	£627	1000 x 800
BA0808Z	£719	BA0808AZ	£608	800 x 800

### Rectangular Desk 600mm Deep

Intermediate end frames not available on single sided units.



BA2006Z	£738	BA2006AZ	£665	2000 x 600
BA1806Z	£728	BA1806AZ	£654	1800 x 600
BA1606Z	£721	BA1606AZ	£646	1600 x 600
BA1406Z	£706	BA1406AZ	£635	1400 x 600
BA1206Z	£700	BA1206AZ	£627	1200 x 600
BA1006Z	£690	BA1006AZ	£620	1000 x 600
BA0806Z	£674	BA0806AZ	£603	800 x 600

### Rectangular Desk Double Sided 1600mm Deep

Intermediate end frames supplied with add-on back to back units.



BA2016Z	£1,310	BA2016AZ	£1,250	2000 x 1600
BA1816Z	£1,290	BA1816AZ	£1,226	1800 x 1600
BA1616Z	£1,271	BA1616AZ	£1,204	1600 x 1600
BA1416Z	£1,245	BA1416AZ	£1,182	1400 x 1600
BA1216Z	£1,199	BA1216AZ	£1,162	1200 x 1600
BA1016Z	£1,175	BA1016AZ	£1,137	1000 x 1600
BA0816Z	£1,154	BA0816AZ	£1,113	800 x 1600

### Rectangular Desk Double Sided 1200mm Deep

Intermediate end frames supplied with add-on back to back units.



BA2012Z	£1,188	BA2012AZ	£1,088	2000 x 1200
BA1812Z	£1,170	BA1812AZ	£1,074	1800 x 1200
BA1612Z	£1,157	BA1612AZ	£1,066	1600 x 1200
BA1412Z	£1,136	BA1412AZ	£1,044	1400 x 1200
BA1212Z	£1,122	BA1212AZ	£1,028	1200 x 1200
BA1012Z	£1,107	BA1012AZ	£1,020	1000 x 1200
BA0812Z	£1,097	BA0812AZ	£1,005	800 x 1200



Starter Unit Code	MFC Price	Add-on unit Code	MFC Price	A	B	C
<b>Double Wave Desking Single Sided</b>						
Intermediate end frames not available on single sided units.						
BADW1808Z	£788	BADW1808AZ	£689	1800 x	600 x	800
BADW1608Z	£784	BADW1608AZ	£676	1600 x	600 x	800
BADW1810Z	£818	BADW1810AZ	£723	1800 x	800 x	1000
BADW1610Z	£806	BADW1610AZ	£710	1600 x	800 x	1000

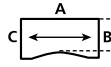

Starter Unit Code	MFC Price	Add-on unit Code	MFC Price	A	B	C
<b>Double Wave Desking Double Sided</b>						
Intermediate end frames supplied with add-on back to back units.						
BADW1816Z	£1,334	BADW1816AZ	£1,274	1800 x	1200 x	1600
BADW1616Z	£1,311	BADW1616AZ	£1,252	1600 x	1200 x	1600
BADW1820Z	£1,395	BADW1820AZ	£1,322	1800 x	1600 x	2000
BADW1620Z	£1,370	BADW1620AZ	£1,296	1600 x	1600 x	2000

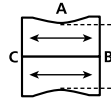

Access Top Double Wave Back to Back Desking with Angled Legs

# BENCH<sup>2</sup> SCALLOP TOP RECTANGULAR DESKING



Desking



### Scallop Top

- A variation on our popular Bench<sup>2</sup> Fixed Top.
- 45mm deep Scallop feature for cable access.
- Accessories are clamped to rear edge of top. Keeps worksurface free of cable ports.
- Accepts optional screens and cable trays.
- Can share end frame on back to back and side to side units resulting in cost effective solutions.



### Leg styles

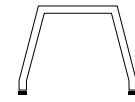

Angled leg prefix code with A

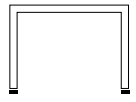

Straight leg

Angled leg not available on double sided add-on units.

Starter Unit Code	MFC Price	Add-on unit Code	MFC Price	A	B
<b>Rectangular Desk 1000mm Deep</b>					
Intermediate end frames not available on single sided units.					
BFS2010Z	£732	BFS2010AZ	£638	2000	x 1000
BFS1810Z	£725	BFS1810AZ	£633	1800	x 1000
BFS1610Z	£721	BFS1610AZ	£622	1600	x 1000
BFS1410Z	£706	BFS1410AZ	£606	1400	x 1000
BFS1210Z	£696	BFS1210AZ	£593	1200	x 1000
BFS1010Z	£689	BFS1010AZ	£578	1000	x 1000
BFS0810Z	£676	BFS0810AZ	£570	800	x 1000



Starter Unit Code	MFC Price	Add-on unit Code	MFC Price	A	B
<b>Double Sided Rectangular Desk 2000mm Deep</b>					
Intermediate end frames supplied with back to back add-on units.					
BFS2020Z	£1,216	BFS2020AZ	£1,137	2000	x 2000
BFS1820Z	£1,199	BFS1820AZ	£1,121	1800	x 2000
BFS1620Z	£1,176	BFS1620AZ	£1,101	1600	x 2000
BFS1420Z	£1,157	BFS1420AZ	£1,077	1400	x 2000
BFS1220Z	£1,134	BFS1220AZ	£1,054	1200	x 2000
BFS1020Z	£1,112	BFS1020AZ	£1,034	1000	x 2000
BFS0820Z	£1,097	BFS0820AZ	£1,014	800	x 2000



Starter Unit Code	MFC Price	Add-on unit Code	MFC Price	A	B
<b>Rectangular Desk 800mm Deep</b>					
Intermediate end frames not available on single sided units.					
BFS2008Z	£677	BFS2008AZ	£576	2000	x 800
BFS1808Z	£670	BFS1808AZ	£563	1800	x 800
BFS1608Z	£641	BFS1608AZ	£555	1600	x 800
BFS1408Z	£634	BFS1408AZ	£547	1400	x 800
BFS1208Z	£622	BFS1208AZ	£534	1200	x 800
BFS1008Z	£609	BFS1008AZ	£518	1000	x 800
BFS0808Z	£601	BFS0808AZ	£508	800	x 800



Starter Unit Code	MFC Price	Add-on unit Code	MFC Price	A	B
<b>Double Sided Rectangular Desk 1600mm Deep</b>					
Intermediate end frames supplied with back to back add-on units.					
BFS2016Z	£1,113	BFS2016AZ	£1,043	2000	x 1600
BFS1816Z	£1,100	BFS1816AZ	£1,024	1800	x 1600
BFS1616Z	£1,074	BFS1616AZ	£1,005	1600	x 1600
BFS1416Z	£1,060	BFS1416AZ	£988	1400	x 1600
BFS1216Z	£1,037	BFS1216AZ	£961	1200	x 1600
BFS1016Z	£1,012	BFS1016AZ	£940	1000	x 1600
BFS0816Z	£990	BFS0816AZ	£924	800	x 1600



Starter Unit Code	MFC Price	Add-on unit Code	MFC Price	A	B
<b>Rectangular Desk 600mm Deep</b>					
Intermediate end frames not available on single sided units.					
BFS2006Z	£603	BFS2006AZ	£527	2000	x 600
BFS1806Z	£595	BFS1806AZ	£518	1800	x 600
BFS1606Z	£584	BFS1606AZ	£510	1600	x 600
BFS1406Z	£576	BFS1406AZ	£504	1400	x 600
BFS1206Z	£561	BFS1206AZ	£490	1200	x 600
BFS1006Z	£554	BFS1006AZ	£474	1000	x 600
BFS0806Z	£543	BFS0806AZ	£465	800	x 600



Starter Unit Code	MFC Price	Add-on unit Code	MFC Price	A	B
<b>Double Sided Rectangular Desk 1200mm Deep</b>					
Intermediate end frames supplied with back to back add-on units.					
BFS2012Z	£994	BFS2012AZ	£912	2000	x 1200
BFS1812Z	£977	BFS1812AZ	£896	1800	x 1200
BFS1612Z	£957	BFS1612AZ	£876	1600	x 1200
BFS1412Z	£938	BFS1412AZ	£860	1400	x 1200
BFS1212Z	£912	BFS1212AZ	£832	1200	x 1200
BFS1012Z	£895	BFS1012AZ	£814	1000	x 1200
BFS0812Z	£875	BFS0812AZ	£797	800	x 1200



Scallop Top Rectangular Single Sided Desking with Angled Legs

# BENCH<sup>2</sup> SCALLOP TOP WAVE DESKING

Starter Unit Code	MFC Price	Add-on unit Code	MFC Price	A	B	C
<b>Right hand Wave Desk 800/1000mm</b>						
Intermediate end frames not available on single sided units.						
BWSR1808Z	£692	BWSR1808AZ	£603	1800	800	1000
BWSR1608Z	£688	BWSR1608AZ	£594	1600	800	1000
BWSR1408Z	£674	BWSR1408AZ	£579	1400	800	1000
BWSR1208Z	£667	BWSR1208AZ	£563	1200	800	1000

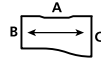

Starter Unit Code	MFC Price	Add-on unit Code	MFC Price	A	B	C
<b>Double Wave Desk</b>						
Intermediate end frames not available on single sided units.						
BFSDW1808Z	£692	BFSDW1808AZ	£603	1800	600	800
BFSDW1608Z	£688	BFSDW1608AZ	£594	1600	600	800
BFSDW1810Z	£751	BFSDW1810AZ	£652	1800	800	1000
BFSDW1610Z	£735	BFSDW1610AZ	£643	1600	800	1000

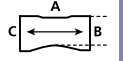

Starter Unit Code	MFC Price	Add-on unit Code	MFC Price	A	B	C
<b>Left hand Wave Desk 800/1000mm</b>						
Intermediate end frames not available on single sided units.						
BWSL1808Z	£692	BWSL1808AZ	£603	1800	800	1000
BWSL1608Z	£688	BWSL1608AZ	£594	1600	800	1000
BWSL1408Z	£674	BWSL1408AZ	£579	1400	800	1000
BWSL1208Z	£667	BWSL1208AZ	£563	1200	800	1000

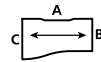

Starter Unit Code	MFC Price	Add-on unit Code	MFC Price	A	B	C
<b>Double Wave Double Sided Desk Back to Back</b>						
Intermediate end frames supplied with back to back add-on units.						
BFSDW1816Z	£1,140	BFSDW1816AZ	£1,070	1800	1200	1600
BFSDW1616Z	£1,123	BFSDW1616AZ	£1,045	1600	1200	1600
BFSDW1820Z	£1,243	BFSDW1820AZ	£1,165	1800	1600	2000
BFSDW1620Z	£1,220	BFSDW1620AZ	£1,144	1600	1600	2000

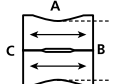

Starter Unit Code	MFC Price	Add-on unit Code	MFC Price	A	B	C
<b>Right hand Wave Desk 600/800mm</b>						
Intermediate end frames not available on single sided units.						
BWSR1806Z	£670	BWSR1806AZ	£584	1800	600	800
BWSR1606Z	£664	BWSR1606AZ	£575	1600	600	800
BWSR1406Z	£652	BWSR1406AZ	£560	1400	600	800
BWSR1206Z	£643	BWSR1206AZ	£553	1200	600	800

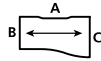

Starter Unit Code	MFC Price	Add-on unit Code	MFC Price	A	B	C
<b>Double Sided Wave Desk 600/800mm Back to Back</b>						
Intermediate end frames supplied with back to back add-on units.						
BWSC1816Z	£1,073	BWSC1816AZ	£1,023	1800	1600	1200
BWSC1616Z	£1,058	BWSC1616AZ	£1,005	1600	1600	1200
BWSC1416Z	£1,042	BWSC1416AZ	£991	1400	1600	1200
BWSC1216Z	£1,023	BWSC1216AZ	£988	1200	1600	1200

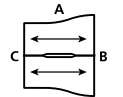

Starter Unit Code	MFC Price	Add-on unit Code	MFC Price	A	B	C
<b>Left hand Wave Desk 600/800mm</b>						
Intermediate end frames not available on single sided units.						
BWSL1806Z	£670	BWSL1806AZ	£584	1800	600	800
BWSL1606Z	£664	BWSL1606AZ	£575	1600	600	800
BWSL1406Z	£652	BWSL1406AZ	£560	1400	600	800
BWSL1206Z	£643	BWSL1206AZ	£553	1200	600	800

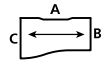

Starter Unit Code	MFC Price	Add-on unit Code	MFC Price	A	B	C
<b>Double Sided Wave Desk 800/1000mm Back to Back</b>						
Intermediate end frames supplied with back to back add-on units.						
BWSC1820Z	£1,140	BWSC1820AZ	£1,070	1800	2000	1600
BWSC1620Z	£1,123	BWSC1620AZ	£1,045	1600	2000	1600
BWSC1420Z	£1,102	BWSC1420AZ	£1,032	1400	2000	1600
BWSC1220Z	£1,077	BWSC1220AZ	£1,012	1200	2000	1600

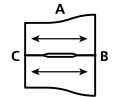

Scallop Top Back to Back Rectangular Desks with Angled Legs

# BENCH<sup>2</sup> SCALLOP TOP DESKING



Desking



### Scallop Top

- A variation on our popular Bench<sup>2</sup> Fixed Top.
- 45mm deep Scallop feature for cable access.
- Accessories are clamped to rear edge of top. Keeps worksurface free of cable ports.
- Accepts optional screens and cable trays.
- Can share end frame on back to back and side to side units resulting in cost effective solutions.



### Leg styles

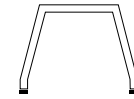

Angled leg prefix code with A



Straight leg

Angled leg not available on double sided add-on units.

Starter Unit Code	MFC Price	Add-on unit Code	MFC Price
-------------------	-----------	------------------	-----------

### Right Handed - Angular Desking

Intermediate end frames not available on single sided units.

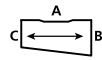

BFSAR1806Z	£670	BFSAR1806AZ	£584
BFSAR1808Z	£692	BFSAR1808AZ	£603

A	B	C
1800 x 800 x 600		
1800 x 1000 x 800		

### Workstation Back to Back Cluster

Code	A	B	C	D	MFC Price
BUSC1824Z	1800	x 1600	x 600	x 2400	£1,700
BUSC1624Z	1600	x 1600	x 600	x 2400	£1,679
BUSC1424Z	1400	x 1600	x 600	x 2400	£1,667

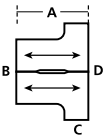

### Left Handed - Angular Desking

Intermediate end frames not available on single sided units.

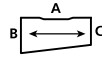

BFSAL1806Z	£670	BFSAL1806AZ	£584
BFSAL1808Z	£692	BFSAL1808AZ	£603

A	B	C
1800 x 800 x 600		
1800 x 1000 x 800		

### Workstation 4 Way Cluster

Code	A	B	C	D	MFC Price
BUSC3624Z	3600	x 1600	x 1200	x 2400	£2,940
BUSC3224Z	3200	x 1600	x 1200	x 2400	£2,887
BUSC2824Z	2800	x 1600	x 1200	x 2400	£2,866

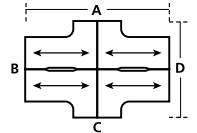

### Double Sided Angular Desking

Intermediate end frames supplied with back to back add-on units.

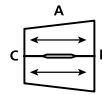

BFSAC1812Z	£1,073	BFSAC1812AZ	£1,023
BFSAC1816Z	£1,140	BFSAC1816AZ	£1,070

A	B	C
1800 x 1600 x 1200		
1800 x 2000 x 1600		

### 120° Symmetrical Workstation

BSSW1208Z	1200	x 800	x 800	x 1200	£901
BSSW1206Z	1200	x 600	x 600	x 1200	£868
BSSW1006Z	1000	x 600	x 600	x 1000	£854

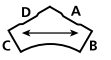

### Right Handed - Angular Conference Desk

Intermediate end frames not available on single sided units.

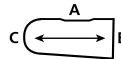

BFSAR22DZ	£787	BFSAR22DAZ	£696
-----------	------	------------	------

A	B
2200 x 1000 x 800	

### 120° 3 Way Workstation Cluster

BSSWC1216Z	1200	x 800	x 800	x 1200	£2,243
BSSWC1212Z	1200	x 600	x 600	x 1200	£2,172
BSSWC1012Z	1000	x 600	x 600	x 1000	£2,117

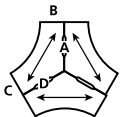

Scallop Top Double Sided with Angled Legs

# BENCH<sup>2</sup> SCALLOP TOP DESKING

Code      A      B      C      D      MFC Price

**Right Hand - Workstation**

BUSR1812Z	1800	x 800	x 600	x 1200	
BUSR1612Z	1600	x 800	x 600	x 1200	
BUSR1412Z	1400	x 800	x 600	x 1200	

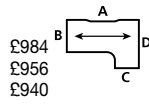

£984  
£956  
£940

Code      A      B      MFC Price

**800mm Fixed top return units -  
To suit 800 deep only**

BRSU126Z	1200	x 600		
BRSU106Z	1000	x 600		
BRSU086Z	800	x 600		

£527  
£513  
£507

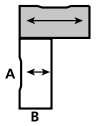

**Left Hand - Workstation**

BUSL1812Z	1800	x 800	x 600	x 1200	
BUSL1612Z	1600	x 800	x 600	x 1200	
BUSL1412Z	1400	x 800	x 600	x 1200	

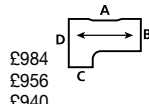

£984  
£956  
£940

**Workstation Side to Side Cluster  
Shared 1200mm Endframe**

BUSC3612Z	3600	x 800	x 1200	x 1200	
BUSC3212Z	3200	x 800	x 1200	x 1200	
BUSC2812Z	2800	x 800	x 1200	x 1200	

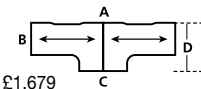

£1,679  
£1,659  
£1,648



Scallop Top Double Wave Back to Back Desking with Straight Legs

# BENCH<sup>2</sup> FIXED TOP RECTANGULAR DESKING



Deskings



### Fixed Top

- Cable access via cable ports.
- Accepts optional cable tray.
- Accessories i.e. Screens and Monitor Arms are fixed to the top via a cable port.
- Can share end frame on back to back and side to side units resulting in cost effective solutions.



Leg styles

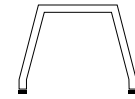

Angled leg prefix code with A



Straight leg

Angled leg not available on double sided add-on units.

Starter Unit Code	MFC Price	Add-on unit Code	MFC Price	A	B
<b>Rectangular Desk 1000mm Deep</b>					
Intermediate end frames not available on single sided units.					
BF2010Z	£732	BF2010AZ	£638	2000	1000
BF1810Z	£725	BF1810AZ	£633	1800	1000
BF1610Z	£721	BF1610AZ	£622	1600	1000
BF1410Z	£706	BF1410AZ	£606	1400	1000
BF1210Z	£696	BF1210AZ	£593	1200	1000
BF1010Z	£689	BF1010AZ	£578	1000	1000
BF0810Z	£676	BF0810AZ	£570	800	1000



Starter Unit Code	MFC Price	Add-on unit Code	MFC Price	A	B
<b>Double Sided Rectangular Desk 2000mm Deep</b>					
Intermediate end frames supplied with back to back add-on units.					
BF2020Z	£1,216	BF2020AZ	£1,137	2000	2000
BF1820Z	£1,199	BF1820AZ	£1,121	1800	2000
BF1620Z	£1,176	BF1620AZ	£1,101	1600	2000
BF1420Z	£1,157	BF1420AZ	£1,077	1400	2000
BF1220Z	£1,134	BF1220AZ	£1,054	1200	2000
BF1020Z	£1,112	BF1020AZ	£1,034	1000	2000
BF0820Z	£1,097	BF0820AZ	£1,014	800	2000

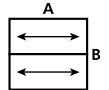

Starter Unit Code	MFC Price	Add-on unit Code	MFC Price	A	B
<b>Rectangular Desk 800mm Deep</b>					
Intermediate end frames not available on single sided units.					
BF2008Z	£677	BF2008AZ	£576	2000	800
BF1808Z	£670	BF1808AZ	£563	1800	800
BF1608Z	£641	BF1608AZ	£555	1600	800
BF1408Z	£634	BF1408AZ	£547	1400	800
BF1208Z	£622	BF1208AZ	£534	1200	800
BF1008Z	£609	BF1008AZ	£518	1000	800
BF0808Z	£601	BF0808AZ	£508	800	800



Starter Unit Code	MFC Price	Add-on unit Code	MFC Price	A	B
<b>Double Sided Rectangular Desk 1600mm Deep</b>					
Intermediate end frames supplied with back to back add-on units.					
BF2016Z	£1,113	BF2016AZ	£1,043	2000	1600
BF1816Z	£1,100	BF1816AZ	£1,024	1800	1600
BF1616Z	£1,074	BF1616AZ	£1,005	1600	1600
BF1416Z	£1,060	BF1416AZ	£988	1400	1600
BF1216Z	£1,037	BF1216AZ	£961	1200	1600
BF1016Z	£1,012	BF1016AZ	£940	1000	1600
BF0816Z	£990	BF0816AZ	£924	800	1600

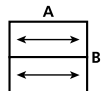

Starter Unit Code	MFC Price	Add-on unit Code	MFC Price	A	B
<b>Rectangular Desk 600mm Deep</b>					
Intermediate end frames not available on single sided units.					
BF2006Z	£603	BF2006AZ	£527	2000	600
BF1806Z	£595	BF1806AZ	£518	1800	600
BF1606Z	£584	BF1606AZ	£510	1600	600
BF1406Z	£576	BF1406AZ	£504	1400	600
BF1206Z	£561	BF1206AZ	£490	1200	600
BF1006Z	£554	BF1006AZ	£474	1000	600
BF0806Z	£543	BF0806AZ	£465	800	600



Starter Unit Code	MFC Price	Add-on unit Code	MFC Price	A	B
<b>Double Sided Rectangular Desk 1200mm Deep</b>					
Intermediate end frames supplied with back to back add-on units.					
BF2012Z	£994	BF2012AZ	£912	2000	1200
BF1812Z	£977	BF1812AZ	£896	1800	1200
BF1612Z	£957	BF1612AZ	£876	1600	1200
BF1412Z	£938	BF1412AZ	£860	1400	1200
BF1212Z	£912	BF1212AZ	£832	1200	1200
BF1012Z	£895	BF1012AZ	£814	1000	1200
BF0812Z	£875	BF0812AZ	£797	800	1200

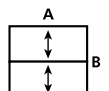

10 Year  
Guarantee

# BENCH<sup>2</sup> FIXED TOP RECTANGULAR DESKING

Desking

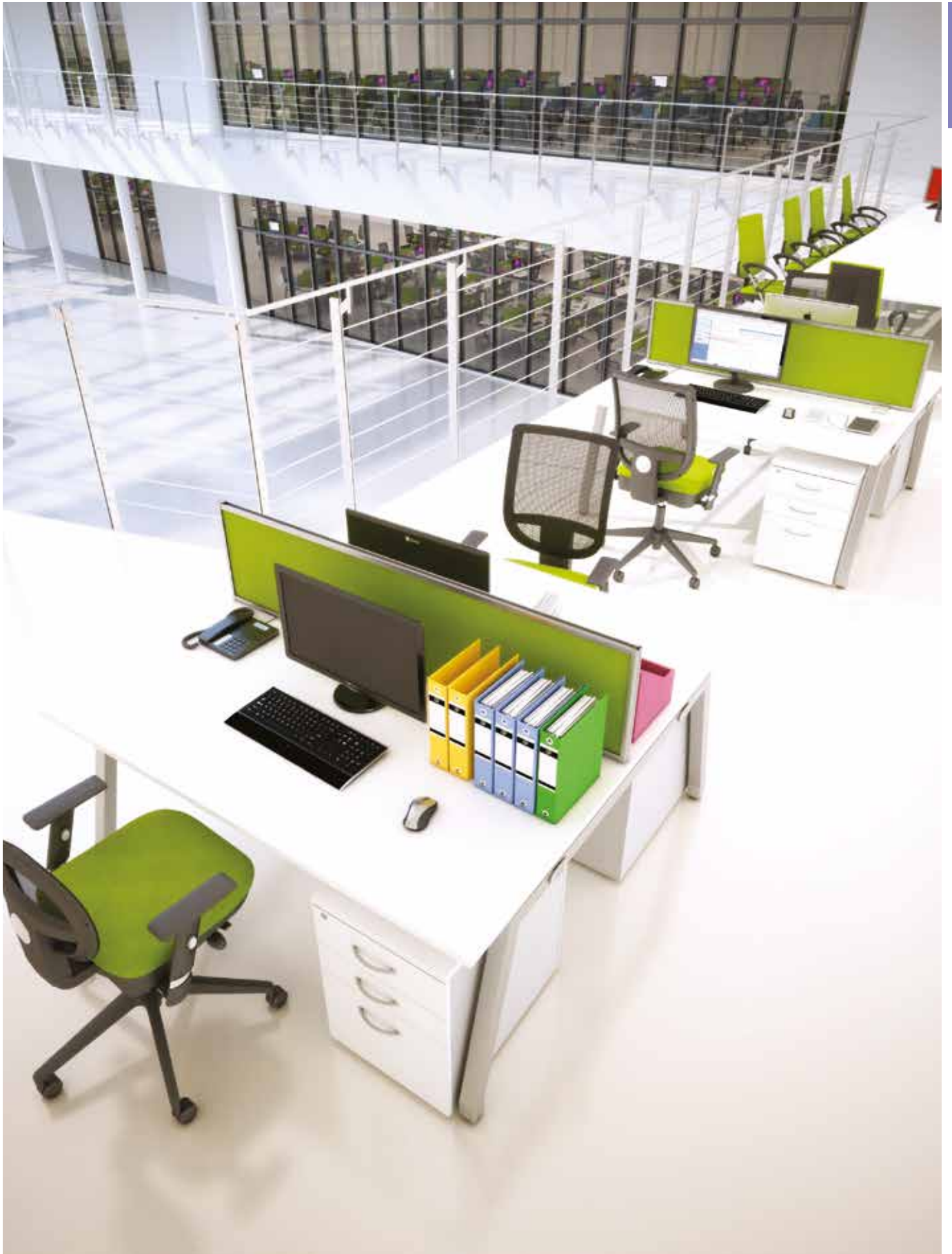

Fixed Top Rectangular Back to Back Desking with Angled Legs

# BENCH<sup>2</sup> FIXED TOP WAVE DESKING



Desking



### Fixed Top

- Cable access via cable ports.
- Accepts optional cable tray.
- Accessories i.e. Screens and Monitor Arms are fixed to the top via a cable port.
- Can share end frame on back to back and side to side units resulting in cost effective solutions.



### Leg styles

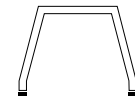

Angled leg prefix code with A

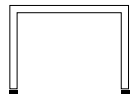

Straight leg

Angled leg not available on double sided add-on units.

Starter Unit Code	MFC Price	Add-on unit Code	MFC Price	A	B	C
<b>Right hand Wave Desk 600/800mm</b>						
Intermediate end frames not available on single sided units.						
BWR1806Z	£670	BWR1806AZ	£584	1800	600	800
BWR1606Z	£664	BWR1606AZ	£575	1600	600	800
BWR1406Z	£652	BWR1406AZ	£560	1400	600	800
BWR1206Z	£643	BWR1206AZ	£553	1200	600	800

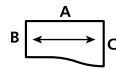

Starter Unit Code	MFC Price	Add-on unit Code	MFC Price	A	B	C
<b>Double Sided Wave Desk 600/800mm Back to Back</b>						
Intermediate end frames supplied with back to back add-on units.						
BWC1816Z	£1,073	BWC1816AZ	£1,023	1800	1600	1200
BWC1616Z	£1,058	BWC1616AZ	£1,005	1600	1600	1200
BWC1416Z	£1,042	BWC1416AZ	£991	1400	1600	1200
BWC1216Z	£1,023	BWC1216AZ	£988	1200	1600	1200

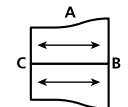

Starter Unit Code	MFC Price	Add-on unit Code	MFC Price	A	B	C
<b>Left hand Wave Desk 600/800mm</b>						
Intermediate end frames not available on single sided units.						
BWL1806Z	£670	BWL1806AZ	£584	1800	600	800
BWL1606Z	£664	BWL1606AZ	£575	1600	600	800
BWL1406Z	£652	BWL1406AZ	£560	1400	600	800
BWL1206Z	£643	BWL1206AZ	£553	1200	600	800

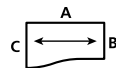

Starter Unit Code	MFC Price	Add-on unit Code	MFC Price	A	B	C
<b>Double Sided Wave Desk 800/1000mm Back to Back</b>						
Intermediate end frames supplied with back to back add-on units.						
BWC1820Z	£1,140	BWC1820AZ	£1,070	1800	2000	1600
BWC1620Z	£1,123	BWC1620AZ	£1,045	1600	2000	1600
BWC1420Z	£1,102	BWC1420AZ	£1,032	1400	2000	1600
BWC1220Z	£1,077	BWC1220AZ	£1,012	1200	2000	1600

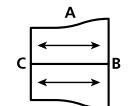

Starter Unit Code	MFC Price	Add-on unit Code	MFC Price	A	B	C
<b>Right hand Wave Desk 800/1000mm</b>						
Intermediate end frames not available on single sided units.						
BWR1808Z	£692	BWR1808AZ	£603	1800	800	1000
BWR1608Z	£688	BWR1608AZ	£594	1600	800	1000
BWR1408Z	£674	BWR1408AZ	£579	1400	800	1000
BWR1208Z	£667	BWR1208AZ	£563	1200	800	1000

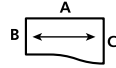

Starter Unit Code	MFC Price	Add-on unit Code	MFC Price	A	B	C
<b>Double Wave Desk</b>						
Intermediate end frames not available on single sided units.						
BFDW1808Z	£692	BFDW1808AZ	£603	1800	600	800
BFDW1608Z	£688	BFDW1608AZ	£594	1600	600	800
BFDW1810Z	£751	BFDW1810AZ	£652	1800	800	1000
BFDW1610Z	£735	BFDW1610AZ	£643	1600	800	1000

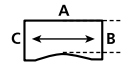

Starter Unit Code	MFC Price	Add-on unit Code	MFC Price	A	B	C
<b>Left hand Wave Desk 800/1000mm</b>						
Intermediate end frames not available on single sided units.						
BWL1808Z	£692	BWL1808AZ	£603	1800	800	1000
BWL1608Z	£688	BWL1608AZ	£594	1600	800	1000
BWL1408Z	£674	BWL1408AZ	£579	1400	800	1000
BWL1208Z	£667	BWL1208AZ	£563	1200	800	1000

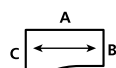

Starter Unit Code	MFC Price	Add-on unit Code	MFC Price	A	B	C
<b>Double Wave Double Sided Desk Back to Back</b>						
Intermediate end frames supplied with back to back add-on units.						
BFDW1816Z	£1,140	BFDW1816AZ	£1,070	1800	1200	1600
BFDW1616Z	£1,123	BFDW1616AZ	£1,045	1600	1200	1600
BFDW1820Z	£1,243	BFDW1820AZ	£1,165	1800	1600	2000
BFDW1620Z	£1,220	BFDW1620AZ	£1,144	1600	1600	2000

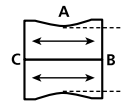

Single Sided Fixed Top Wave Desk with Straight Legs



10 Year  
Guarantee

# BENCH<sup>2</sup> FIXED TOP WAVE DESKING

Desking



Double Wave Back to Back Desking with Straight Legs

# BENCH<sup>2</sup> FIXED TOP DESKING



Desking



### Fixed Top

- Cable access via cable ports.
- Accepts optional cable tray.
- Accessories i.e. Screens and Monitor Arms are fixed to the top via a cable port.
- Can share end frame on back to back and side to side units resulting in cost effective solutions.



### Leg styles

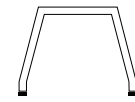

Angled leg  
prefix code with A

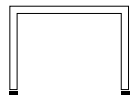

Straight leg

Angled leg not available on double sided add-on units.

Starter Unit Code	MFC Price	Add-on unit Code	MFC Price
-------------------	-----------	------------------	-----------

### Right Handed - Angular Desking

Intermediate end frames not available on single sided units.

BFAR1806Z	£670	BFAR1806AZ	£584
BFAR1808Z	£692	BFAR1808AZ	£603

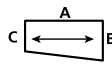

### Left Handed - Angular Desking

Intermediate end frames not available on single sided units.

BFAL1806Z	£670	BFAL1806AZ	£584
BFAL1808Z	£692	BFAL1808AZ	£603

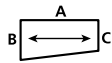

### Double Sided Angular Desking

Intermediate end frames supplied with back to back add-on units.

BFAC1812Z	£1,073	BFAC1812AZ	£1,023
BFAC1816Z	£1,140	BFAC1816AZ	£1,070

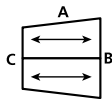

### Right Handed - Angular Conference Desk

Intermediate end frames not available on single sided units.

BFAR22DZ	£787	BFAR22DAZ	£696
----------	------	-----------	------

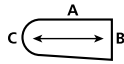

### Left Handed - Angular Conference Desk

Intermediate end frames not available on single sided units.

BFAL22DZ	£787	BFAL22DAZ	£696
----------	------	-----------	------

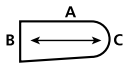

### Workstation Back to Back Cluster

Code	A	B	C	D	MFC Price
BUC1824Z	1800	x 1600	x 600	x 2400	£1,700
BUC1624Z	1600	x 1600	x 600	x 2400	£1,679
BUC1424Z	1400	x 1600	x 600	x 2400	£1,667

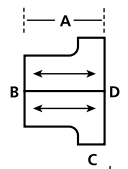

### Workstation 4 Way Cluster

BUC3624Z	3600	x 1600	x 1200	x 2400	£2,940
BUC3224Z	3200	x 1600	x 1200	x 2400	£2,887
BUC2824Z	2800	x 1600	x 1200	x 2400	£2,866

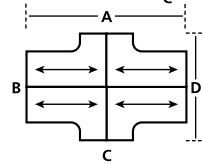

### 120° Symmetrical Workstation

BSW1208Z	1200	x 800	x 800	x 1200	£901
BSW1206Z	1200	x 600	x 600	x 1200	£868
BSW1006Z	1000	x 600	x 600	x 1000	£854

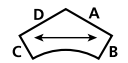

### 120° 3 Way Workstation Cluster

BSWC1216Z	1200	x 800	x 800	x 1200	£2,243
BSWC1212Z	1200	x 600	x 600	x 1200	£2,172
BSWC1012Z	1000	x 600	x 600	x 1000	£2,117

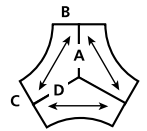

Code	A	B	C	D	MFC Price
------	---	---	---	---	-----------

### Right Hand - Workstation

BUR1812Z	1800	x 800	x 600	x 1200	£984
BUR1612Z	1600	x 800	x 600	x 1200	£956
BUR1412Z	1400	x 800	x 600	x 1200	£940

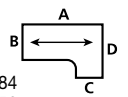

### Left Hand - Workstation

BUL1812Z	1800	x 800	x 600	x 1200	£984
BUL1612Z	1600	x 800	x 600	x 1200	£956
BUL1412Z	1400	x 800	x 600	x 1200	£940

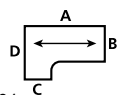

### Workstation Side to Side Cluster Shared 1200mm Endframe

BUC3612Z	3600	x 800	x 1200	x 1200	£1,679
BUC3212Z	3200	x 800	x 1200	x 1200	£1,659
BUC2812Z	2800	x 800	x 1200	x 1200	£1,648

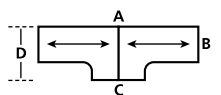

Code	A	B	MFC Price
------	---	---	-----------

### 800mm Fixed top return units - To suit 800 deep only

BRU126Z	1200	x 600	£527
BRU106Z	1000	x 600	£513
BRU086Z	800	x 600	£507

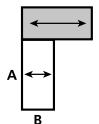

10 Year  
Guarantee

## BENCH<sup>2</sup> FIXED TOP DESKING

Desking

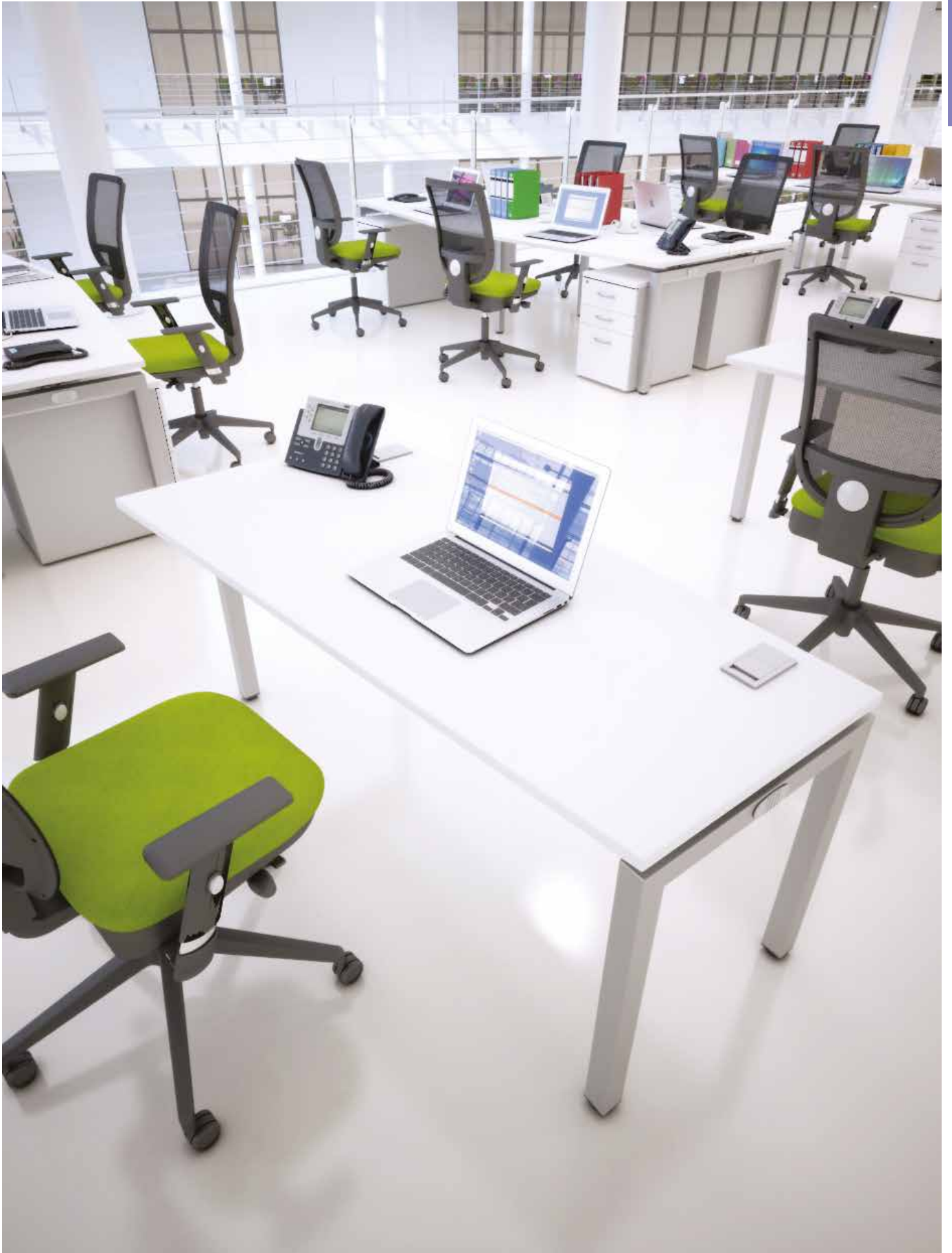

Fixed Top Single Angular Desk with Straight Legs

# BENCH<sup>2</sup> HEIGHT ADJUSTABLE DESKING

10 Year  
Guarantee

Deskings

- Manual operated with removable handle.
- Fits to all legs - both front & rear.
- Cable spines are available for vertical cable management rise & fall.
- Can be used with under desk pedestals (except 600mm deep desks).

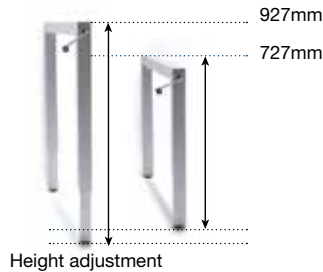

Maximum Load  
Per Top (evenly distributed)

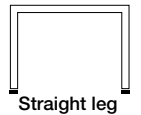

Code      A      B      C      MFC Price

### 800mm Deep Rectangular Desking

BFH1808	1800 x	800		£1,764
BFH1608	1600 x	800		£1,727
BFH1408	1400 x	800		£1,715
BFH1208	1200 x	800		£1,695
BFH1008	1000 x	800		£1,687
BFH0808	800 x	800		£1,664

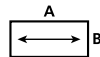

### 600mm Deep Rectangular Desking

BFH1806	1800 x	600		£1,690
BFH1606	1600 x	600		£1,676
BFH1406	1400 x	600		£1,661
BFH1206	1200 x	600		£1,642
BFH1006	1000 x	600		£1,629
BFH0806	800 x	600		£1,606



### Right Hand 800mm Deep Wave Desking

BFHWR188	1800 x	800 x	1000	£1,783
BFHWR168	1600 x	800 x	1000	£1,772
BFHWR148	1400 x	800 x	1000	£1,755
BFHWR128	1200 x	800 x	1000	£1,742

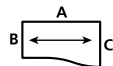

### Left Hand 800mm Deep Wave Desking

BFHWL188	1800 x	800 x	1000	£1,783
BFHWL168	1600 x	800 x	1000	£1,772
BFHWL148	1400 x	800 x	1000	£1,755
BFHWL128	1200 x	800 x	1000	£1,742

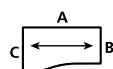

### Right Hand 600mm Deep Wave Desking

BFHWR186	1800 x	600 x	800	£1,769
BFHWR166	1600 x	600 x	800	£1,750
BFHWR146	1400 x	600 x	800	£1,740
BFHWR126	1200 x	600 x	800	£1,725

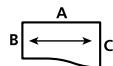

### Left Hand 600mm Deep Wave Desking

BFHWL186	1800 x	600 x	800	£1,769
BFHWL166	1600 x	600 x	800	£1,750
BFHWL146	1400 x	600 x	800	£1,740
BFHWL126	1200 x	600 x	800	£1,725

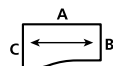

### Double Wave Desking

BFHDW186Z	1800 x	600 x	800	£1,769
BFHDW166Z	1600 x	600 x	800	£1,750

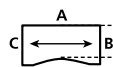

Code      A      B      C      MFC Price

### Right hand Angular Desking

BFHAR188	1800 x	1000 x	800	£1,783
BFHAR186	1800 x	800 x	600	£1,769

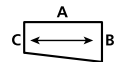

### Left Hand Angular Desking

BFHAL188	1800 x	1000 x	800	£1,783
BFHAL186	1800 x	800 x	600	£1,769

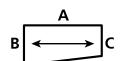

### Right Hand Angular Conference Desking

BFHAR228	2200 x	1000 x	800	£1,876
----------	--------	--------	-----	--------

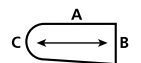

### Left Hand Angular Conference Desking

BFHAL228	2200 x	1000 x	800	£1,876
----------	--------	--------	-----	--------

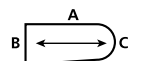

10 Year  
Guarantee

## BENCH<sup>2</sup> HEIGHT ADJUSTABLE DESKING

Deskling



Height Adjustable Rectangular Desks

# BENCH<sup>2</sup> ACCESSORIES

## DESKING



Desking

**Code      W      D      H      MFC Price**

### Single Sided Over Desk Shelving

Fits to Fixed Top, Scallop Top  
(used on single sided desks).



BTSS20Z	2000	x 300	x 420	£277
BTSS18Z	1800	x 300	x 420	£256
BTSS16Z	1600	x 300	x 420	£229
BTSS14Z	1400	x 300	x 420	£207
BTSS12Z	1200	x 300	x 420	£182
BTSS10Z	1000	x 300	x 420	£163
BTSS08Z	800	x 300	x 420	£147



**Code      W      H      Desk Size      MFC Price**

### Suspended Modesty Panels

Fits to rear side of single Fixed Top  
and Scallop Top desking only.



BTCPW20	1826	x 250	2000	£107
BTCPW18	1626	x 250	1800	£102
BTCPW16	1426	x 250	1600	£96
BTCPW14	1226	x 250	1400	£90
BTCPW12	1026	x 250	1200 & 120°	£79
BTCPW10	826	x 250	1000 & 120°	£76
BTCPW08	626	x 250	800	£71



### Double Sided Over Desk Shelving

Fits to Fixed Top, Scallop Top  
(used on back to back desks).



BTDS20Z	2000	x 600	x 420	£362
BTDS18Z	1800	x 600	x 420	£330
BTDS16Z	1600	x 600	x 420	£297
BTDS14Z	1400	x 600	x 420	£266
BTDS12Z	1200	x 600	x 420	£235
BTDS10Z	1000	x 600	x 420	£211
BTDS08Z	800	x 600	x 420	£193



### Infill End Frames - Complete Units

**Fits On Straight Frame Only**

Supplementary price, must be specified at point of order.



BECP20	2000	Shared	£345
BECP16	1600	Shared	£323
BECP12	1200	Shared	£261
BECP10	1000		£228
BECP08	800		£201
BECP06	600		£188



### Height Adjustable Kit Fitting To Bench<sup>2</sup> Underframe

AVAILABLE ON ACCESS TOP.  
AVAILABLE ON FIXED & SCALLOP TOP WHEN DESK MOUNTED SCREENS ARE NOT USED.

Manually selective to fixed positions. Height adjustment between 727 & 827mm in 20mm increments.  
Kits raise a single work surface to the desired height and can be ordered with desks or retro-fitted to existing units.  
They can be fitted to stand alone desks or to units within clusters without affecting existing cable management or screens.

Code	To fit desk	Price
BRHA10	1000mm deep rectangular desks	£109
BRHA08	800mm deep rectangular desks & 800/1000mm deep wave & angular desks	£107
BRHA06	600mm deep rectangular desks & 600/800mm deep wave & angular desks	£104

Bench Code      A      B      Price

Circular Conference End  
Add-on for 800mm Deep Rectangular Desking.

BFCE12Z	800	x	Ø1200	£674
---------	-----	---	-------	------



Tear Drop Conference End

Circular Conference End  
Add-on for 800mm Deep Rectangular Desking.

BFTE12Z	800	x	Ø1200	£766
---------	-----	---	-------	------



Circular Conference End

Circular End Tables  
Add-on for 1600mm/1200mm Deep Rectangular Desking.

BFTSC16Z	Ø1600	x	800	£697
BFTSC12Z	Ø1200	x	600	£697



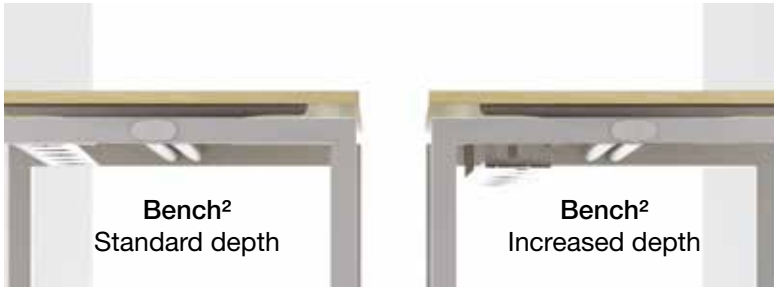

### Information - Cable tray positions

All Bench Squared cable trays come complete with brackets that cater for most cabling requirements.

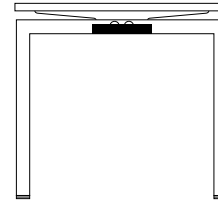

Standard depth 75mm

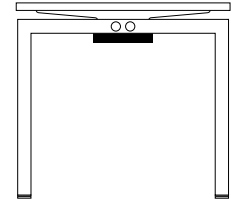

Increased depth 130mm

Cable trays are sold as standard with Access Top and as optional extras to Fixed & Scallop Top desking. They need only be specified where required for Fixed and Scallop Top. Depth of brackets must be specified for all Bench<sup>2</sup> cable trays including Access Top. Cable risers and spines fit to Access, Fixed & Scallop Top desking.



**Please note: Only 555 High under desk pedestals fit underneath increased depth cable trays.**

Code	Where Used	Price
<b>Cable Trays - Fixed Top Desking Double Sided</b>		
Complete with brackets, for increased depth brackets Suffix code with - I		
BFCT20D	2000mm desk	£166
BFCT18D	1800mm desk & workstation	£155
BFCT16D	1600mm desk & workstation	£153
BFCT14D	1400mm desk & workstation	£148
BFCT12D	1200mm desk	£130
BFCT10D	1000mm desk	£126
BFCT10D-3	1200mm 120° workstation	£126
BFCT08D-3	1000mm 120° workstation	£123
BFCT08D	800mm desk	£123



Double sided cable tray

Code	Where Used	Price
<b>Cable Trays - Fixed Top Desking Single Sided</b>		
Complete with brackets, for increased depth brackets Suffix code with - I		
BFCT20S	2000mm desk	£107
BFCT18S	1800mm desk & workstation	£100
BFCT16S	1600mm desk & workstation	£96
BFCT14S	1400mm desk & workstation	£93
BFCT12S	1200mm desk	£82
BFCT10S	1000mm desk	£77
BFCT10S-3	1200mm 120° workstation	£77
BFCT08S-3	1000mm 120° workstation	£74
BFCT08S	800mm desk	£74



Single sided cable tray

Code	Where Used	Price
<b>Cable Trays - End Caps</b>		
Optional items used to blank off ends of run trays - Used with increased depth cable trays		
BCTECD	Double sided - increased depth cable trays	£57
BCTECS	Single sided - increased depth cable trays	£57



Cable tray end caps

**Cable Riser, Cable Spines & Suspended CPU Holders**  
Fits to Access, Fixed & Scallop Top desking. BUPUH1 Fits to Bench<sup>2</sup> spines at any point.

BFCR	For use with Standard depth cable trays	£112
BFCL	For use with Increased depth cable trays	£112
BCRB	Cable spine (Black)	£86
BCRS	Cable spine (Silver)	£86
BCRW	Cable spine (White)	£86
BCPUH1	To suit CPU up to 90w x 290h - 240w x 510h	£239
BCPUHA	Infinitely adjustable with Allen key Adaptor bracket - used when CPU holder is fitted to desks with increased depth cable trays	£42



BFCR



BCRS



BCPUH1

# MESA & MESA PLUS DESKING

10 Year  
Guarantee

Desking

Mesa and Mesa Plus are stripped-back Bench desking ranges that combine strength with ease of assembly and use. Both feature 45mm scalloped tops for cable access and shared componentry for cost effective cluster solutions. Two distinct leg versions are available for Mesa and Mesa Plus.



Leg styles

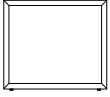

Codi leg prefix code with C

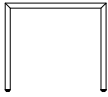

Straight leg

Codi leg not available on double sided add-on units.

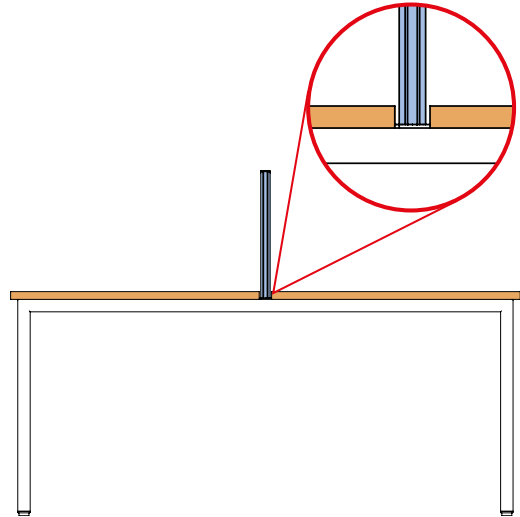

## MESA

Mesa can be used with and without GOF screens. All screens sit on desk worksurfaces and fixing brackets are visible. Will require user modifications.

For GOF Desktop Screens see the Screens Section of the Product Guide

## MESA PLUS

Mesa Plus screens sit between desk worksurfaces and fixings are discreet, keeping top panels clear. **Mesa Plus cannot be used with GOF screens.**

For Mesa Plus Desktop Screens see the Screens Section of the Product Guide



Mesa Rectangular Double Sided Desking



## Mesa and Mesa Plus Footprints (Shown with straight legs)

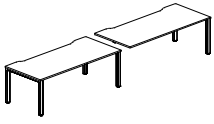

Single Sided

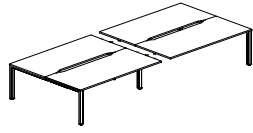

Double Sided

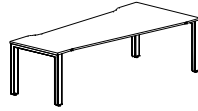

Single Wave  
Right-Hand

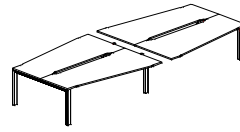

Double Sided  
Single Wave

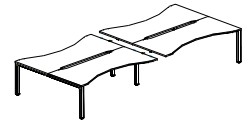

Double Sided  
Double Wave

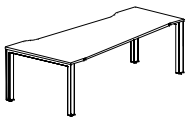

Single Wave  
Left-Hand

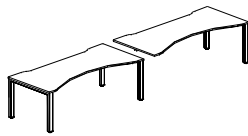

Single Sided  
Double Wave



120° Symmetrical  
Workstation

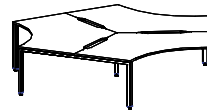

120° 3 User Workstation  
Cluster



Mesa Plus Codi Rectangular Double Sided Desking

# MESA & MESA PLUS RECTANGULAR DESKING

10 Year Guarantee

Desking

Mesa & Mesa Plus are stripped-back Bench desking ranges that combine strength with ease of assembly and use.

Double sided rectangular clusters share end frame components between back to back worksurfaces and when joined side to side.

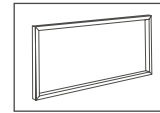

For Mesa Codi add 'C' prefix to product code. i.e. CMEF2012

Mesa Starter Unit Code	Mesa Plus Starter Unit Code	MFC Price	Mesa Add-On Unit Code	Mesa Plus Add-On Unit Code	MFC Price	A	B	Optional Cable Basket Code
------------------------	-----------------------------	-----------	-----------------------	----------------------------	-----------	---	---	----------------------------

## 1200mm Deep Double Sided Rectangular Desking

Intermediate End Frames supplied with back to back add-on units.

MEF2012	MPF2012	£702	MEF2012A	MPF2012A	£627	2000	x	1200	MECT20D
MEF1812	MPF1812	£627	MEF1812A	MPF1812A	£552	1800	x	1200	MECT18D
MEF1612	MPF1612	£597	MEF1612A	MPF1612A	£522	1600	x	1200	MECT16D
MEF1412	MPF1412	£552	MEF1412A	MPF1412A	£478	1400	x	1200	MECT14D
MEF1212	MPF1212	£537	MEF1212A	MPF1212A	£462	1200	x	1200	MECT12D
MEF1012	MPF1012	£522	MEF1012A	MPF1012A	£448	1000	x	1200	MECT10D
MEF0812	MPF0812	£508	MEF0812A	MPF0812A	£432	800	x	1200	MECT08D

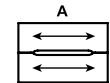

## 1600mm Deep Double Sided Rectangular Desking

Intermediate End Frames supplied with back to back add-on units.

MEF2016	MPF2016	£819	MEF2016A	MPF2016A	£673	2000	x	1600	MECT20D
MEF1816	MPF1816	£746	MEF1816A	MPF1816A	£597	1800	x	1600	MECT18D
MEF1616	MPF1616	£715	MEF1616A	MPF1616A	£567	1600	x	1600	MECT16D
MEF1416	MPF1416	£687	MEF1416A	MPF1416A	£537	1400	x	1600	MECT14D
MEF1216	MPF1216	£656	MEF1216A	MPF1216A	£508	1200	x	1600	MECT12D
MEF1016	MPF1016	£627	MEF1016A	MPF1016A	£478	1000	x	1600	MECT10D
MEF0816	MPF0816	£597	MEF0816A	MPF0816A	£448	800	x	1600	MECT08D

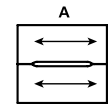

Mesa Plus Rectangular Double Sided Desking

# MESA & MESA PLUS RECTANGULAR DESKING

Mesa & Mesa Plus are stripped-back Bench desking ranges that combine strength with ease of assembly and use.

Single sided rectangular desks share end frame components when joined side to side.

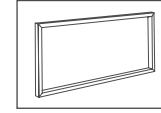

For Mesa Codi add 'C' prefix to product code. i.e. CMEF2006

Mesa Starter Unit Code	Mesa Plus Starter Unit Code	MFC Price	Mesa Add-On Unit Code	Mesa Plus Add-On Unit Code	MFC Price	A	B	Optional Cable Basket Code
------------------------	-----------------------------	-----------	-----------------------	----------------------------	-----------	---	---	----------------------------

### 600mm Deep Single Sided Rectangular Desking

Intermediate End Frames not available on single sided units.

MEF2006	MPF2006	£448	MEF2006A	MPF2006A	£330	2000	x	600	MECT20
MEF1806	MPF1806	£417	MEF1806A	MPF1806A	£297	1800	x	600	MECT18
MEF1606	MPF1606	£401	MEF1606A	MPF1606A	£284	1600	x	600	MECT16
MEF1406	MPF1406	£388	MEF1406A	MPF1406A	£270	1400	x	600	MECT14
MEF1206	MPF1206	£376	MEF1206A	MPF1206A	£253	1200	x	600	MECT12
MEF1006	MPF1006	£357	MEF1006A	MPF1006A	£240	1000	x	600	MECT10
MEF0806	MPF0806	£343	MEF0806A	MPF0806A	£224	800	x	600	MECT08

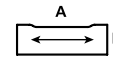

### 800mm Deep Single Sided Rectangular Desking

Intermediate End Frames not available on single sided units.

MEF2008	MPF2008	£522	MEF2008A	MPF2008A	£388	2000	x	800	MECT20
MEF1808	MPF1808	£478	MEF1808A	MPF1808A	£343	1800	x	800	MECT18
MEF1608	MPF1608	£462	MEF1608A	MPF1608A	£330	1600	x	800	MECT16
MEF1408	MPF1408	£448	MEF1408A	MPF1408A	£314	1400	x	800	MECT14
MEF1208	MPF1208	£432	MEF1208A	MPF1208A	£297	1200	x	800	MECT12
MEF1008	MPF1008	£417	MEF1008A	MPF1008A	£284	1000	x	800	MECT10
MEF0808	MPF0808	£401	MEF0808A	MPF0808A	£270	800	x	800	MECT08

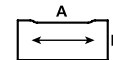

Mesa Plus Codi Rectangular Double Sided Desking

# MESA & MESA PLUS WAVE DESKING

10 Year  
Guarantee

Desking

Mesa & Mesa Plus are stripped-back Bench desking ranges that combine strength with ease of assembly and use.

Single Wave desks are designed to position equipment into the deeper corner of the worksurface whilst angling users to improve their focus.

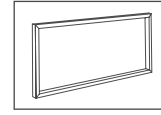

For Mesa Codi add 'C' prefix to product code. i.e. CMEWR2008

Mesa Starter Unit Code	Mesa Plus Starter Unit Code	MFC Price	Mesa Add-On Unit Code	Mesa Plus Add-On Unit Code	MFC Price
------------------------	-----------------------------	-----------	-----------------------	----------------------------	-----------

### Right-Hand 800 / 600mm Deep Single Sided Wave Desking

Intermediate End Frames not available on single sided units.

MEWR2008	MPWR2008	£508	N/A	N/A	N/A
MEWR1808	MPWR1808	£478	N/A	N/A	N/A
MEWR1608	MPWR1608	£462	N/A	N/A	N/A
MEWR1408	MPWR1408	£448	N/A	N/A	N/A
MEWR1208	MPWR1208	£432	N/A	N/A	N/A

A B C Optional Cable Basket Code

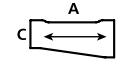

2000	x	800	x	600	MECT20
1800	x	800	x	600	MECT18
1600	x	800	x	600	MECT16
1400	x	800	x	600	MECT14
1200	x	800	x	600	MECT12

### Left-Hand 800 / 600mm Deep Single Sided Wave Desking

Intermediate End Frames not available on single sided units.

MEWL2008	MPWL2008	£508	N/A	N/A	N/A
MEWL1808	MPWL1808	£478	N/A	N/A	N/A
MEWL1608	MPWL1608	£462	N/A	N/A	N/A
MEWL1408	MPWL1408	£448	N/A	N/A	N/A
MEWL1208	MPWL1208	£432	N/A	N/A	N/A

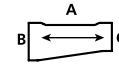

2000	x	800	x	600	MECT20
1800	x	800	x	600	MECT18
1600	x	800	x	600	MECT16
1400	x	800	x	600	MECT14
1200	x	800	x	600	MECT12

### Suspended Modesty Panel

Fits to rear edge of Mesa & Mesa Plus Single Sided Desks. Please specify board and metalwork finishes.

Code	W	H	Desk Size	MFC Price
BTCPW20	1826 x	250	2000	£102
BTCPW18	1626 x	250	1800	£98
BTCPW16	1426 x	250	1600	£92
BTCPW14	1226 x	250	1400	£86
BTCPW12*	1026 x	250	1200 & 120°	£76
BTCPW10	826 x	250	1000	£73
BTCPW08	626 x	250	800	£68

\* Fits to 1200 desk & rear edges of 120° Workstation.



Mesa Plus Double Sided Rectangular Desking

# MESA & MESA PLUS WAVE DESKING

Mesa & Mesa Plus are stripped-back Bench desking ranges that combine strength with ease of assembly and use.

Double Wave desks are shaped to sit the user centrally to the desk, with the curved front edge providing an ergonomic user interface.

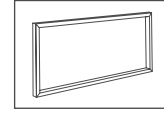

For Mesa Codi add 'C' prefix to product code. i.e. CMEWC2016

A B C Optional Cable Basket Code

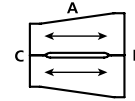

Mesa Starter Unit Code	Mesa Plus Starter Unit Code	MFC Price	Mesa Add-On Unit Code	Mesa Plus Add-On Unit Code	MFC Price
------------------------	-----------------------------	-----------	-----------------------	----------------------------	-----------

### 800 / 600mm Deep Double Sided Wave Desking

Intermediate End Frames supplied with back to back add-on units.

MEWC2016	MPWC2016	£807	MEWC2016A	MPWC2016A	£733	2000	x	1600	x	1200	MECT20D
MEWC1816	MPWC1816	£746	MEWC1816A	MPWC1816A	£673	1800	x	1600	x	1200	MECT18D
MEWC1616	MPWC1616	£715	MEWC1616A	MPWC1616A	£642	1600	x	1600	x	1200	MECT16D
MEWC1416	MPWC1416	£687	MEWC1416A	MPWC1416A	£612	1400	x	1600	x	1200	MECT14D
MEWC1216	MPWC1216	£656	MEWC1216A	MPWC1216A	£583	1200	x	1600	x	1200	MECT12D

### Double Wave Single Sided Desking

Intermediate End Frames not available on single sided units.

MEFDW2008	MPFDW2008	£508	MEFDW2008A	MPFDW2008A	£388	2000	x	600	x	800	MECT20
MEFDW1808	MPFDW1808	£478	MEFDW1808A	MPFDW1808A	£357	1800	x	600	x	800	MECT18
MEFDW1608	MPFDW1608	£462	MEFDW1608A	MPFDW1608A	£343	1600	x	600	x	800	MECT16

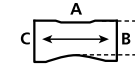

### Double Wave Double Sided Desking

Intermediate End Frames supplied with back to back add-on units.

MEFDW2016	MPFDW2016	£807	MEFDW2016A	MPFDW2016A	£733	2000	x	1200	x	1600	MECT20D
MEFDW1816	MPFDW1816	£746	MEFDW1816A	MPFDW1816A	£673	1800	x	1200	x	1600	MECT18D
MEFDW1616	MPFDW1616	£715	MEFDW1616A	MPFDW1616A	£642	1600	x	1200	x	1600	MECT16D

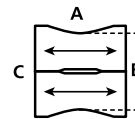

Mesa Plus Double Sided Double Wave Desking

# MESA & MESA PLUS 120° DESKING



Desking

Mesa & Mesa Plus are stripped-back Bench desking ranges that combine strength with ease of assembly and use.

120° Workstations are designed for individual use or for use in radial clusters, with the curved front edge providing an ergonomic interface and the shape offering generous work space.

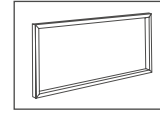

For Mesa Codi add 'C' prefix to product code. i.e. CMESW1208

Mesa Code	Mesa Plus Code	MFC Price	A	B	C	D	Optional Cable Basket Code	
<b>120° Symmetrical Workstation</b>								
MESW1208	MPSW1208	£677	1200	x	800	x	1200	MECT12
MESW1206	MPSW1206	£661	1200	x	600	x	1200	MECT12
<b>120° 3 User Workstation Cluster</b>								
MESWC1208-3	MPSWC1208-3	£1,708	1200	x	800	x	1200	MECT12D
MESWC1206-3	MPSWC1206-3	£1,663	1200	x	600	x	1200	MECT12D

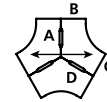
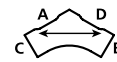

Mesa Plus 120° 3 User Workstation Cluster

# MESA & MESA PLUS 120° DESKING

Mesa & Mesa Plus are stripped-back Bench desking ranges that combine strength with ease of assembly and use.

120° Workstations are designed for individual use or for use in radial clusters, with the curved front edge providing an ergonomic interface and the shape offering generous work space.

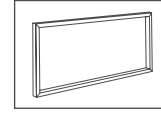

For Mesa Codi add 'C' prefix to product code. i.e. CMESWC1208-6

Mesa Code	Mesa Plus Code	MFC Price	A	B	C	D	Optional Cable Basket Code		
MESWC1208-6	MPSWC1208-6	£3,271	1200	x	800	x	800	1200	MECT12D
MESWC1206-6	MPSWC1206-6	£3,252	1200	x	600	x	600	1200	MECT12D
MESWC1208-9	MPSWC1208-9	£4,827	1200	x	800	x	800	1200	MECT12D
MESWC1206-9	MPSWC1206-9	£4,812	1200	x	600	x	600	1200	MECT12D



Mesa Plus Codi

# D3K MANUAL HEIGHT ADJUSTABLE DESKING

10 Year Guarantee

Desking

- Height range 680 to 930mm.
- Manually adjustable using retractable handle.
- Available in Rectangular, Wave & Consult desk footprints.
- Accepts horizontal cable management.
- For circular cable ports, please substitute "Z" in code for "P".



Maximum Load  
Per Top (evenly distributed)



Under desk pedestals 55mm high

Code	A	B	C	MFC Price	Code	A	B	C	MFC Price
------	---	---	---	-----------	------	---	---	---	-----------

## Rectangular Desk

Can be used with under desk pedestals (55mm High)

GDSH18Z	1800	x	800	£1,433
GDSH16Z	1600	x	800	£1,329
GDSH14Z	1400	x	800	£1,287
GDSH12Z	1200	x	800	£1,263
GDSH10Z	1000	x	800	£1,244
GDSH08Z	800	x	800	£1,229

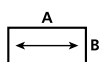

## Double Wave Desk

Can be used with under desk pedestals. (55mm High)

GDWHD18Z	1800	x	800	x	1000	£1,537
GDWHD16Z	1600	x	800	x	1000	£1,433

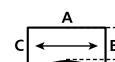

## Left Hand Wave Desk

Can be used with under desk pedestals. (55mm High)

GDWHL18Z	1800	x	800	x	1000	£1,537
GDWHL16Z	1600	x	800	x	1000	£1,433
GDWHL14Z	1400	x	800	x	1000	£1,395
GDWHL12Z	1200	x	800	x	1000	£1,367

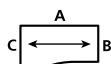

## Right Hand Wave Desk

Can be used with under desk pedestals. (55mm High)

GDWHR18Z	1800	x	800	x	1000	£1,537
GDWHR16Z	1600	x	800	x	1000	£1,433
GDWHR14Z	1400	x	800	x	1000	£1,395
GDWHR12Z	1200	x	800	x	1000	£1,367

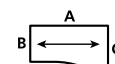

## Left Hand Consult Desk

Can be used with under desk pedestals. (55mm High)

GCDHL21Z	2100	x	800	x	Ø1000	£1,546
GCDHL19Z	1900	x	800	x	Ø1000	£1,488
GCDHL17Z	1700	x	800	x	Ø1000	£1,444

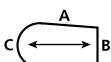

## Right Hand Consult Desk

Can be used with under desk pedestals. (55mm High)

GCDHR21Z	2100	x	800	x	Ø1000	£1,546
GCDHR19Z	1900	x	800	x	Ø1000	£1,488
GCDHR17Z	1700	x	800	x	Ø1000	£1,444

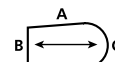

Rectangular Height Adjustable Desk





- A modern executive style fully panel ended desk collection offering stylish looks and traditional standards.
- Available in a variety of desk and workstation footprints.
- Available with 36mm thick MFC or 25mm thick MFC top panels. All have 25mm thick MFC panel ends. Overall heights are 738mm or 727mm.
- Suffix code with relevant letter for required thickness of top panel.

- Delivered and installed fully assembled.
- Extra deep modesty panel available (30mm from floor) (subject to £62 surcharge). Suffix code with - FD.

Code	A	B	C	Group Z 25mm MFC	Group B 36mm MFC
<b>800mm Deep Rectangular Desking</b>					
Can be used with fixed, under desk, tall under desk or desk high pedestals *Cannot accept fixed pedestals.					
KNPD18	1800 x	800		£522	£734
KNPD16	1600 x	800		£451	£665
KNPD14	1400 x	800		£424	£636
KNPD12	1200 x	800		£399	£609
KNPD10	1000 x	800		£381	£595
KNPD08	800 x	800		£378	£591

Code	A	B	C	Group Z 25mm MFC	Group B 36mm MFC
<b>600mm Deep Rectangular Desking</b>					
Can be used with desk high pedestals.					
KNPD186	1800 x	600		£479	£692
KNPD166	1600 x	600		£412	£627
KNPD146	1400 x	600		£381	£595
KNPD126	1200 x	600		£357	£573
KNPD106	1000 x	600		£346	£559
KNPD086	800 x	600		£338	£550

Code	A	B	C	Group Z 25mm MFC	Group B 36mm MFC
<b>Right Hand - Wave Desking</b>					
Can be used with fixed, tall under desk, under desk or desk high pedestals on 800mm side only.					
KNPDWR18	1800 x	800 x	1000	£563	£781
KNPDWR16	1600 x	800 x	1000	£534	£751
KNPDWR14	1400 x	800 x	1000	£500	£718

Code	A	B	C	Group Z 25mm MFC	Group B 36mm MFC
<b>Left Hand - Wave Desking</b>					
Can be used with fixed, tall under desk, under desk or desk high pedestals on 800mm side only.					
KNPDWL18	1800 x	800 x	1000	£563	£781
KNPDWL16	1600 x	800 x	1000	£534	£751
KNPDWL14	1400 x	800 x	1000	£500	£718

Code	A	B	C	Group Z 25mm MFC	Group B 36mm MFC
<b>Kidney Desking</b>					
Can be used with tall under desk or under desk pedestals.					
KNPDK22	2200 x	800		£845	£1,059
KNPDK20	2000 x	800		£817	£1,027
KNPDK18	1800 x	800		£792	£1,006
KNPDK16	1600 x	800		£767	£980

Code	A	B	C	Group Z 25mm MFC	Group B 36mm MFC
<b>Bow Fronted Desking</b>					
Can be used with fixed, tall under desk, under desk or desk high pedestals.					
KNPDB20	2000 x	1000 x	800	£688	£899
KNPDB18	1800 x	1000 x	800	£658	£869
KNPDB16	1600 x	1000 x	800	£560	£771



EX10 Universal Workstation

# EX10 EXECUTIVE DESKING



Desking

- A modern executive style fully panel ended desk collection offering stylish looks and traditional standards.
- Available in a variety of desk and workstation footprints.
- Available with 36mm thick MFC or 25mm thick MFC top panels. All have 25mm thick MFC panel ends. Overall heights are 738mm or 727mm.
- Suffix code with relevant letter for required thickness of top panel.



- Delivered and installed fully assembled.
- Extra deep modesty panel available (30mm from floor) (subject to £62 surcharge). Suffix code with - FD.

Code	A	B	C	D	Group Z 25mm MFC	Group B 36mm MFC			
<b>Right Hand - Universal Workstations</b>									
Can be used with fixed, tall under desk, under desk or desk high pedestals.									
KNPUWS20R	2000	x	800	x	600	x	1200	£722	£933
KNPUWS18R	1800	x	800	x	600	x	1200	£688	£899
KNPUWS16R	1600	x	800	x	600	x	1200	£648	£862
KNPUWS14R	1400	x	800	x	600	x	1200	£622	£834

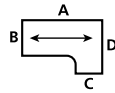

Code	A	B	C	D	Group Z 25mm MFC	Group B 36mm MFC			
<b>Left Hand - Bow Fronted Workstation</b>									
Can be used with fixed, tall under desk, under desk or desk high pedestals.									
KNPBWS20L	2000	x	800	x	600	x	1200	£862	£1,073
KNPBWS18L	1800	x	800	x	600	x	1200	£818	£1,028
KNPBWS16L	1600	x	800	x	600	x	1200	£781	£991

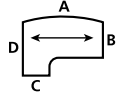

Code	A	B	C	D	Group Z 25mm MFC	Group B 36mm MFC			
<b>Left Hand - Universal Workstations</b>									
Can be used with fixed, tall under desk, under desk or desk high pedestals.									
KNPUWS20L	2000	x	800	x	600	x	1200	£722	£933
KNPUWS18L	1800	x	800	x	600	x	1200	£688	£899
KNPUWS16L	1600	x	800	x	600	x	1200	£648	£862
KNPUWS14L	1400	x	800	x	600	x	1200	£622	£834

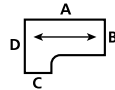

Code	A	B	C	D	Group Z 25mm MFC	Group B 36mm MFC			
<b>Right Hand - Consult Fronted Workstations</b>									
Can be used with tall under desk, under desk or desk high pedestals.									
KNPCWS22R	2200	x	800	x	600	x	1200	£984	£1,198
KNPCWS20R	2000	x	800	x	600	x	1200	£937	£1,150
KNPCWS18R	1800	x	800	x	600	x	1200	£891	£1,102

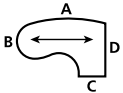

Code	A	B	C	D	Group Z 25mm MFC	Group B 36mm MFC			
<b>Right Hand - Bow Fronted Workstation</b>									
Can be used with fixed, tall under desk, under desk or desk high pedestals.									
KNPBWS20R	2000	x	800	x	600	x	1200	£862	£1,073
KNPBWS18R	1800	x	800	x	600	x	1200	£818	£1,028
KNPBWS16R	1600	x	800	x	600	x	1200	£781	£991

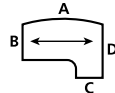

Code	A	B	C	D	Group Z 25mm MFC	Group B 36mm MFC			
<b>Left Hand - Consult Fronted Workstations</b>									
Can be used with tall under desk, under desk or desk high pedestals.									
KNPCWS22L	2200	x	800	x	600	x	1200	£984	£1,198
KNPCWS20L	2000	x	800	x	600	x	1200	£937	£1,150
KNPCWS18L	1800	x	800	x	600	x	1200	£891	£1,102

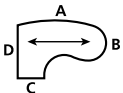

EX10 Executive Bow Fronted

- Cut back leg prices are surcharges and are additional to Desk/Workstation price.
- When Workstations/Desks are positioned adjacent to each other, movement between work positions can be improved.
- If cut back legs are utilised the base of the leg is reduced from 800 to 600mm and 600 to 450mm.
- When ordering please specify left or right hand position.

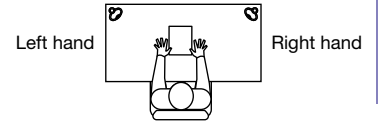

Code	Description	Where Used	Price
<b>EX10 Executive Cut Back Legs</b>			
25mm MFC			
KNCBR8Z	Right Hand	Any 800d Desk or 800 side of Workstation	£119
KNCBL8Z	Left Hand	Any 800d Desk or 800 side of Workstation	£119
KNPCBR6Z	Right Hand	600 side of Workstation	£119
KNPCBL6Z	Left Hand	600 side of Workstation	£119
KNCBR6Z	Right Hand	Any 600d Desk	£119
KNCBL6Z	Left Hand	Any 600d Desk	£119



### 3 Drawer Desk High Pedestals

When ordering please state handle type. See Storage section.  
For 25mm options, please see Storage section.

Base code	W	D	H	36mm MFC Price
<b>Mobile</b>				
KNP3D6M	430	x 600	x 738	£678
KNP3D8M	430	x 800	x 738	£804
<b>Static</b>				
KNP3D6S	430	x 600	x 738	£678
KNP3D8S	430	x 800	x 738	£804



EX10 Executive Left Hand Consult Workstation

# RISE SIT/STAND DESKING

5 Year  
Motor/  
Moving Parts  
Guarantee

10 Year  
Structural  
Guarantee

Deskings

- The Rise family of products, including Rise, Rise Lite and Rise Squared, has been designed to bring true sit/stand capacity to the ever-changing workplace.
- Each model can quickly be adjusted to suit users' height requirements whilst offering both health and lifestyle benefits.
- Available in our most popular footprints and with a selection of control options, Rise offers simple flexibility.

### Available Frame Colours

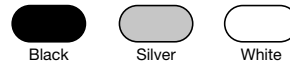

Maximum Load  
Per Top (evenly distributed)

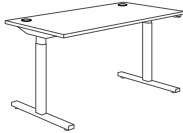

RISE LITE

Rise Lite is a cost-effective version of Rise with no cross bar and a Type A control panel. Rise Lite can be dressed for the occasion with a selection of optional accessories, such as cable trays, spines or modesty panels.

- Rectangular ✔
- Single Wave ✔
- Double Wave (P.O.A.) ✔
- Workstations ✘
- 120 Degree Workstations ✘

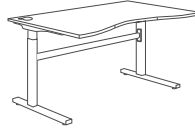

RISE

Rise is a stand-alone desk with a cross bar for enhanced stability. It has cable management and accepts desktop accessories. Cable baskets with cable risers are available to allow for fluid mobility, along with fixed CPU holders.

- Rectangular ✔
- Single Wave ✔
- Double Wave ✔
- Workstations ✔
- 120 Degree Workstations ✔

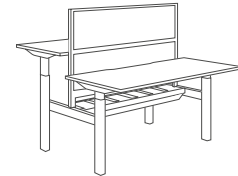

RISE SQUARED

Rise Squared is a premium bank of two desks back to back, integral cable control, split by a two-tier screen. Both desks have a scalloped top for cable egress and accepts desktop accessories.

- Rectangular ✔
- Single Wave (P.O.A.) ✔
- Double Wave (P.O.A.) ✔
- Workstations ✘
- 120 Degree Workstations ✘

### How to specify

1. Select Base Code
2. Add Control Panel
3. Order complete desk

Example of code: HDS18A  
(Type A control panel)

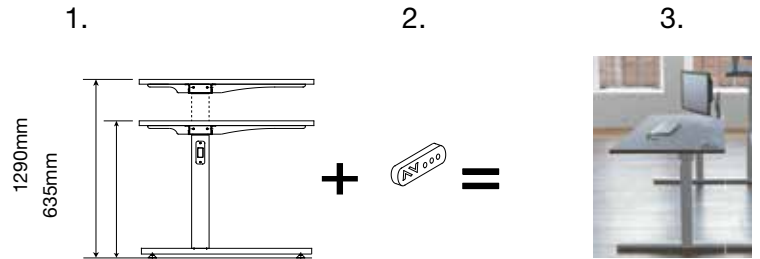

Rise Squared with Endframe Infill Panels



# RISE SIT/STAND DESKING

Desking



### Type 'A' Control Panel

Ideal for users who only require up & down functions. Panel can be retracted when not in use.



### Type 'B' Control Panel

As well as the Up and Down functions, this panel can be programmed with up to three set heights.



### Type 'C' Control Panel

As well as the Up and Down functions, this panel can be programmed with up to three set heights, with digital height display.



### Type 'E' Control Panel

This angled control has an intuitive tilt function for activation. It has integrated Bluetooth connectivity that is compatible with 'Desk Control' apps and a digital display. It can be programmed with up to four memory positions.



### Bluetooth Adapter

Both Rise and Rise Lite can be controlled remotely by using the Bluetooth™ Adaptor and a paired smart device.

HDBA £57



### Clear Cable Spine - 1400

Available on the Rise and Rise LT only.

HDCR £150



Rise Lite with GOF Floor Standing Screens

# RISE SIT/STAND DESKING



Deskings

## Rise Rectangular

From compact forms to larger spans, Rise can be used independently or positioned in clusters, giving both individuals or teams the ability to fine-tune their levels.



Base code	A	B	Optional Cable Basket Code	Type 'A' Price	Type 'B' Price	Type 'C' Price	Type 'E' Price
HDS18	1800	800	MECT18	£1,711	£1,733	£1,811	£1,820
HDS16	1600	800	MECT16	£1,667	£1,688	£1,768	£1,774
HDS14	1400	800	MECT14	£1,625	£1,641	£1,724	£1,731
HDS12	1200	800	MECT12	£1,516	£1,534	£1,618	£1,624
HDS10	1000	800	MECT10	£1,469	£1,488	£1,570	£1,576
HDS08	800	800	MECT08	£1,406	£1,424	£1,507	£1,512

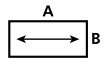

## Rise Wave

When space is at a premium but users need to spread out, Wave desks offer the perfect solution combining simple frames with ergonomic work surfaces.

Base code	A	B	C	Optional Cable Basket Code	Type 'A' Price	Type 'B' Price	Type 'C' Price	Type 'E' Price
<b>Right Hand Single Wave Desks</b>								
HDWR18	1800	800	1000	MECT18	£1,750	£1,768	£1,851	£1,856
HDWR16	1600	800	1000	MECT16	£1,706	£1,725	£1,807	£1,811
HDWR14	1400	800	1000	MECT14	£1,659	£1,677	£1,758	£1,766
HDWR12	1200	800	1000	MECT12	£1,625	£1,641	£1,724	£1,731
<b>Left Hand Single Wave Desks</b>								
HDWL18	1800	800	1000	MECT18	£1,750	£1,768	£1,851	£1,856
HDWL16	1600	800	1000	MECT16	£1,706	£1,725	£1,807	£1,811
HDWL14	1400	800	1000	MECT14	£1,659	£1,677	£1,758	£1,766
HDWL12	1200	800	1000	MECT12	£1,625	£1,641	£1,724	£1,731

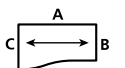
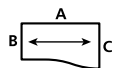

## Double Wave Desks

HDWD18	1800	800	1000	MECT18	£1,750	£1,768	£1,851	£1,856
HDWD16	1600	800	1000	MECT16	£1,706	£1,725	£1,807	£1,811

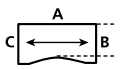

Rise Right Hand Workstation



## Rise Workstation

Whether having lots of equipment or paper, Rise workstations deliver.

Base code	A	B	C	D	Optional Cable Basket Code	Type 'A' Price	Type 'B' Price	Type 'C' Price	Type 'E' Price
HUWSR18	1800	x 800	x 600	x 1200	MECT18	£2,617	£2,633	£2,716	£2,722
HUWSR16	1600	x 800	x 600	x 1200	MECT16	£2,568	£2,585	£2,669	£2,673
HUWSR14	1400	x 800	x 600	x 1200	MECT14	£2,523	£2,539	£2,623	£2,627
HUWSL18	1800	x 800	x 600	x 1200	MECT18	£2,617	£2,633	£2,716	£2,722
HUWSL16	1600	x 800	x 600	x 1200	MECT16	£2,568	£2,585	£2,669	£2,673
HUWSL14	1400	x 800	x 600	x 1200	MECT14	£2,523	£2,539	£2,623	£2,627

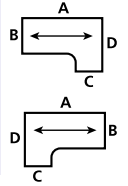

## Rise 120° Workstation

Having to accommodate multiple users or intensive work patterns, sitting or standing, Rise helps position your equipment just where it is needed.

Base code	A	B	C	D	Optional Cable Basket Code	Type 'A' Price	Type 'B' Price	Type 'C' Price	Type 'E' Price
HDY128	1200	x 800	x 800	x 1200	MECT12	£2,587	£2,606	£2,688	£2,694
HDY126	1200	x 600	x 600	x 1200	MECT12	£2,538	£2,559	£2,639	£2,600
HDY106	1000	x 600	x 600	x 1000	MECT10	£2,516	£2,533	£2,616	£2,621

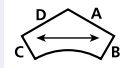

## Modesty Panels

Code	Panel Length	Desk	Price
BTCPW18	1626 x 250	1800	£102
BTCPW16	1426 x 250	1600	£96
BTCPW14	1226 x 250	1400	£90
BTCPW12	1026 x 250	1200	£79

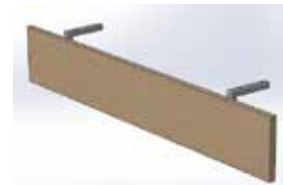

Rise 120 Degree Workstation

# RISE LITE SIT/STAND DESKING



Desking

## Rise Lite Rectangular

Needing a desk or a table, Rise Lite keeps it simple. Fluid and versatile; allowing users to take control of their environment.

- Delivered and installed fully assembled
- A cost effective version of Rise Sit/Stand Desking
- Available with Type A control panel
- No cross bar

### How to specify

1. Select Product / Code with plain top
2. If Ports are required, suffix code with P
3. If Scallop required, suffix code with S

Example: HDLS14S - 1400  
Rectangular Desk with scallop top

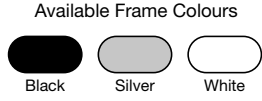
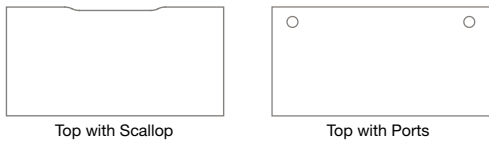

Maximum Load  
Per Top (evenly distributed) **110kg**

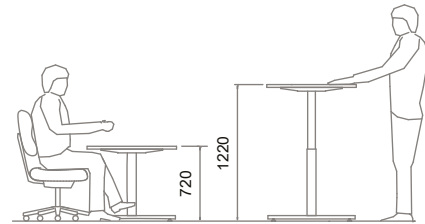

Sit/Stand worksurface range from 720mm to 1220mm

Code	A	B	Optional Cable Basket Code
HDLS18	1800 x	800	MECT18
HDLS16	1600 x	800	MECT16
HDLS14	1400 x	800	MECT14
HDLS12	1200 x	800	MECT12

Plain Top	P (Ports)	S (Scallop)
£1,439	£1,480	£1,480
£1,427	£1,466	£1,466
£1,416	£1,454	£1,454
£1,401	£1,442	£1,442

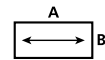

Rise Light with GOF Floor Standing Screens





# RISE LITE SIT/STAND DESKING

Desking

## Rise LiteSingle Wave

Rise Lite can be specified to be cost-effective or dressed for the occasion with a selection of optional accessories, such as cable trays, spines or modesty panels. Rise reaches the grade.

- Delivered and installed fully assembled
- A cost effective version of Rise Sit/Stand Desking
- Available with Type A control panel
- No cross bar

Code	A	B	C	Optional Cable Basket Code	Plain Top	P (Ports)	S (Scallop)
					£1,511 £1,497 £1,485	£1,551 £1,536 £1,523	£1,551 £1,536 £1,523
Right hand							
HDLWR18	1800	800	1000	MECT18			
HDLWR16	1600	800	1000	MECT16			
HDLWR14	1400	800	1000	MECT14			
Left hand							
HDLWL18	1800	800	1000	MECT18	£1,511	£1,551	£1,551
HDLWL16	1600	800	1000	MECT16	£1,497	£1,536	£1,536
HDLWL14	1400	800	1000	MECT14	£1,485	£1,523	£1,523

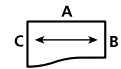
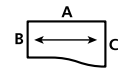

## Modesty Panels

Code	Panel Length	Desk	Price
BTCPW18	1626 x 250	1800	£102
BTCPW16	1426 x 250	1600	£96
BTCPW14	1226 x 250	1400	£90
BTCPW12	1026 x 250	1200	£79



Wave Desks shown back to back with Modesty Panels

# RISE SQUARED SIT/STAND DESKING

5 Year Motor/Moving Parts Guarantee

10 Year Structural Guarantee

Desking

- Scalloped Top for cable egress
- Accepts desk top accessories
- Supplied with integral cable control
- Selection of control panels
- Shared back to back components

Available Frame Colours

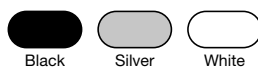

Maximum Load  
Per Top (evenly distributed)



## How to specify

1. Select a base code
2. Add control panels
3. Order complete desk

Example: **HBS1616B** (type B control panel)

Note: Screens ordered separately.

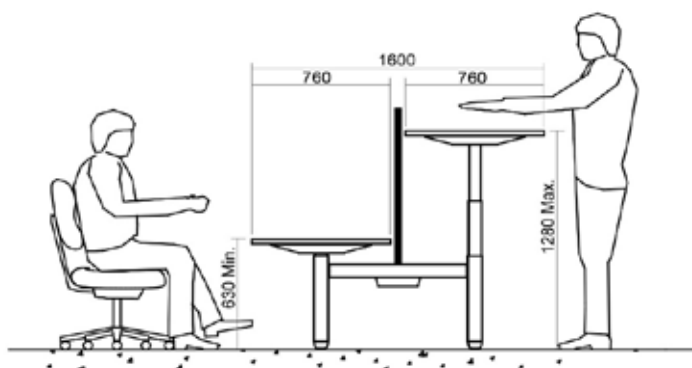

## Desks - with scalloped tops



Code	A	B	2 x Optional Cable Tray	Type 'A' Price	Type 'B' Price	Type 'C' Price	Type 'E' Price
HBS2016	2000	1600	MECT20	£3,441	£3,482	£3,635	£3,656
HBS1816	1800	1600	MECT18	£3,376	£3,414	£3,567	£3,590
HBS1616	1600	1600	MECT16	£3,312	£3,349	£3,501	£3,522
HBS1416	1400	1600	MECT14	£3,246	£3,281	£3,435	£3,456
HBS1216	1200	1600	MECT12	£3,177	£3,215	£3,368	£3,391



Rise Squared with Separator Screen and Endframe Infill Panel

5 Year  
Motor/  
Moving Parts  
Guarantee

10 Year  
Structural  
Guarantee

# RISE SQUARED SIT/STAND DESKING

Desking

## Desk to Desk Chain

Cable control to fit between desks

Code

HBSDDC

Price

£107

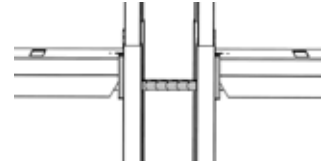

## Endframe Infill Panel

fits between legs and can be used as cable riser

Code

HBSEP

Price

£411

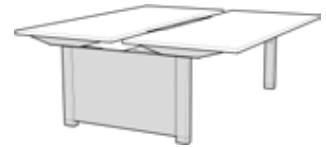

## Screens

Code

W

H

Band 1 Price

Band 2 Price

Band 3 Price

### Fabric

VSFG2014	2000	1400
VSFG1814	1800	1400
VSFG1614	1600	1400
VSFG1414	1400	1400
VSFG1214	1200	1400

£452	£482	£545
£411	£438	£495
£372	£394	£452
£352	£372	£413
£326	£350	£390

### Fabric Separator Screen (positions screen apart)

VSFS0214	200	1400
----------	-----	------

£236	£261	£285
------	------	------

### Part Glazed - Fabric / Acrylic (frosted or clear)

VSAG2014	2000	1400
VSAG1814	1800	1400
VSAG1614	1600	1400
VSAG1414	1400	1400
VSAG1214	1200	1400

£725	£768	£874
£659	£700	£794
£595	£633	£724
£562	£595	£665
£525	£561	£628

### Acrylic Separator Screen (positions screen apart)

VSAS0214	200	1400
----------	-----	------

£238	£292	£316
------	------	------

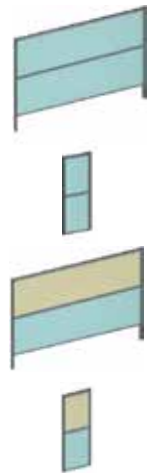

Rise Squared with Separator Screen and HBSEP Endframe Infill Panel

# DESKIT DESKING

10 Year  
Guarantee

Desking

## How to specify:

1. Select range endframe code
2. Add product model base code
3. Order complete desk



Example: EPD188 - 1800 x 800 EX10 Rectangular Desk  
or KND188 - 1800 x 800 X10 Rectangular Desk.



Base Code	A	B	C	Optional Cable Basket	BK	GK	EP	KN	KV	KP	
<b>800mm Deep Rectangular</b>											
D188	1800	800		MECT18	£469	£495	£513	£513	£469	£469	
D168	1600	800		MECT16	£405	£426	£443	£443	£405	£405	
D148	1400	800		MECT14	£377	£403	£414	£414	£377	£377	
D128	1200	800		MECT12	£355	£380	£389	£389	£355	£355	
D108	1000	800		MECT10	£343	£372	£376	£376	£343	£343	
D088	800	800		MECT08	£333	£361	£371	£371	£333	£333	
<b>600mm Deep Rectangular</b>											
D186	1800	600		MECT18	£421	£462	£469	£469	£421	£421	
D166	1600	600		MECT16	£367	£386	£405	£405	£367	£367	
D146	1400	600		MECT14	£341	£356	£376	£376	£341	£341	
D126	1200	600		MECT12	£320	£346	£352	£352	£320	£320	
D106	1000	600		MECT10	£314	£333	£341	£341	£314	£314	
D086	800	600		MECT08	£298	£320	£330	£330	£298	£298	
<b>Right Hand Wave</b>											
RW188	1800	800	1000	MECT18	£505	£563	£556	£556	£505	£505	
RW168	1600	800	1000	MECT16	£478	£495	£527	£527	£478	£478	
RW148	1400	800	1000	MECT14	£446	£469	£492	£492	£446	£446	
RW128	1200	800	1000	MECT12	£432	£448	£473	£473	£432	£432	
RW108	1000	800	1000	MECT10	£420	£436	£462	£462	£420	£420	

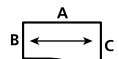
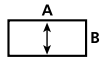
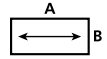

Rectangular Bench Deskit

Base Code	A	B	C	D	Optional Cable Basket	BK	GK	EP	KN	KV	KP	
<b>Left Hand Wave</b>												
LW188	1800	800	1000		MECT18	£505	£563	£556	£556	£505	£505	
LW168	1600	800	1000		MECT16	£478	£495	£527	£527	£478	£478	
LW148	1400	800	1000		MECT14	£446	£469	£492	£492	£446	£446	
LW128	1200	800	1000		MECT12	£432	£448	£473	£473	£432	£432	
LW108	1000	800	1000		MECT10	£420	£436	£462	£462	£420	£420	
<b>Double Wave</b>												
DW188	1800	800	1000		MECT18	£505	£563	£556	£556	£505	£505	
DW168	1600	800	1000		MECT16	£478	£495	£527	£527	£478	£478	
<b>Right Hand D-End</b>												
DDR20	2000	800			MECT16	£570	£590	£610	£610	£570	£570	
DDR18	1800	800			MECT14	£514	£533	£554	£554	£514	£514	
DDR16	1600	800			MECT12	£446	£474	£478	£478	£446	£446	
<b>Left Hand D-End</b>												
DDL20	2000	800			MECT16	£570	£590	£610	£610	£570	£570	
DDL18	1800	800			MECT14	£514	£533	£554	£554	£514	£514	
DDL16	1600	800			MECT12	£446	£474	£478	£478	£446	£446	
<b>Kidney</b>												
KD22	2200	800			MECT14	£788	£810	£831	£831	£788	£788	
KD20	2000	800			MECT12	£760	£782	£799	£799	£760	£760	
KD18	1800	800			MECT10	£739	£762	£776	£776	£739	£739	
KD16	1600	800			MECT08	£705	£723	£754	£754	£705	£705	
<b>Bow Fronted</b>												
BD20	2000	800	1000		MECT20	£630	£652	£671	£671	£630	£630	
BD18	1800	800	1000		MECT18	£603	£628	£644	£644	£603	£603	
BD16	1600	800	1000		MECT16	£508	£529	£553	£553	£508	£508	
<b>120° Workstation</b>												
YD128	1200	800	800	1200	MECT12	£714	£738	£781	£781	£714	£714	
YD126	1200	600	600	1200	MECT12	£690	£714	£756	£756	£690	£690	
YD108	1000	800	800	1000	MECT10	£641	£665	£706	£706	£641	£641	
YD106	1000	600	600	1000	MECT10	£641	£665	£706	£706	£641	£641	



D3K Deskit Left Hand and Right Hand Wave

# DESKIT DESKING



Desking

## How to specify:

1. Select range endframe code
2. Add product model base code
3. Order complete desk



Example: EPD188 - 1800 x 800 EX10 Rectangular Desk  
or KND188 - 1800 x 800 X10 Rectangular Desk.

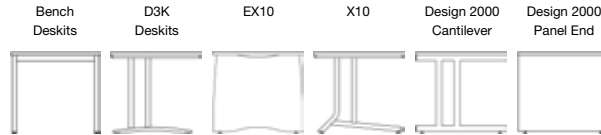

Base Code	A	B	C	D	Optional Cable Basket	BK	GK	EP	KN	KV	KP
<b>RH Workstation - 800mm Return</b>											
UWR188	1800	800	800	1200	MECT16	£667	£701	£730	£730	£667	£667
UWR168	1600	800	800	1200	MECT14	£627	£667	£691	£691	£627	£627
<b>LH Workstation - 800mm Return</b>											
UWL188	1800	800	800	1200	MECT16	£667	£701	£730	£730	£667	£667
UWL168	1600	800	800	1200	MECT14	£627	£667	£691	£691	£627	£627
<b>RH Workstation - 600mm Return</b>											
UWR206	2000	800	600	1200	MECT18	£641	£677	£706	£706	£641	£641
UWR186	1800	800	600	1200	MECT16	£608	£643	£671	£671	£608	£608
UWR166	1600	800	600	1200	MECT14	£579	£612	£636	£636	£579	£579
UWR146	1400	800	600	1200	MECT12	£557	£589	£610	£610	£557	£557
<b>LH Workstation - 600mm Return</b>											
UWL206	2000	800	600	1200	MECT18	£641	£677	£706	£706	£641	£641
UWL186	1800	800	600	1200	MECT16	£608	£643	£671	£671	£608	£608
UWL166	1600	800	600	1200	MECT14	£579	£612	£636	£636	£579	£579
UWL146	1400	800	600	1200	MECT12	£557	£589	£610	£610	£557	£557

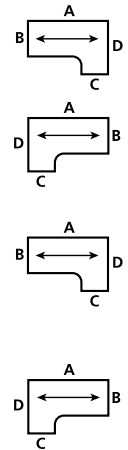

Design 2000 Cantilever Deskit

10 Year Guarantee

# DESKIT DESKING

Desking

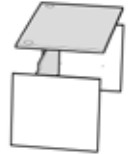

Base Code      A      B      C      D      Optional Cable Basket      BK      GK      EP      KN      KV      KP

**RH Bow Fronted Workstation - 600mm Return**

UWBR206	2000	800	600	1200	MECT18	£742	£781	£809	£809	£742	£742
UWBR186	1800	800	600	1200	MECT16	£723	£745	£772	£772	£723	£723
UWBR166	1600	800	600	1200	MECT14	£681	£714	£738	£738	£681	£681

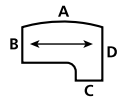

**LH Bow Fronted Workstation - 600mm Return**

UWBL206	2000	800	600	1200	MECT18	£742	£781	£809	£809	£742	£742
UWBL186	1800	800	600	1200	MECT16	£723	£745	£772	£772	£723	£723
UWBL166	1600	800	600	1200	MECT14	£681	£714	£738	£738	£681	£681

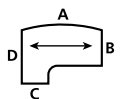

**RH Consult Workstation - 600mm Return**

UWCR226	2200	800	600	1200	MECT16	£935	£970	£995	£995	£935	£935
UWCR206	2000	800	600	1200	MECT14	£900	£936	£961	£961	£900	£900
UWCR186	1800	800	600	1200	MECT12	£874	£904	£925	£925	£874	£874
UWCR166	1600	800	600	1200	MECT10	£846	£879	£899	£899	£846	£846

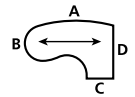

**LH Consult Workstation - 600mm Return**

UWCL226	2200	800	600	1200	MECT16	£935	£970	£995	£995	£935	£935
UWCL206	2000	800	600	1200	MECT14	£900	£936	£961	£961	£900	£900
UWCL186	1800	800	600	1200	MECT12	£874	£904	£925	£925	£874	£874
UWCL166	1600	800	600	1200	MECT10	£846	£879	£899	£899	£846	£846

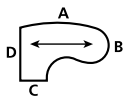

**Symmetrical Workstation**

UW188S	1800	800	800	1800	MECT16	£766	£811	£850	£850	£766	£766
UW168S	1600	800	800	1600	MECT14	£732	£771	£804	£804	£732	£732
UW148S	1400	800	800	1400	MECT12	£701	£742	£769	£769	£701	£701
UW128S	1200	800	800	1200	MECT10	£669	£707	£741	£741	£669	£669
UW126S	1200	600	600	1200	MECT10	£669	£707	£741	£741	£669	£669

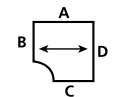

X10 Deskit Right Hand and Left Hand Wave

# DESKIT ADD-ONS

## DESKING



Desking

- Extra deep modesty panel available (57mm from floor) (subject to £62 surcharge). Suffix code with -FD.
- Not available on X10 Desks / Workstations

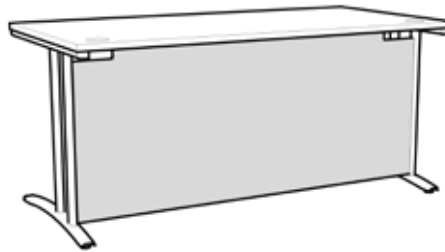

Desk shown with D3K endframes & full depth modesty panel. Example: GKD168FD

### Cut Back Endframes

Cut back endframes for 800d desks can be used to help create additional leg space when desks or workstations are used together. Cantilever frames are best for this. They are offered in Left or Right hand options and are supplied with all necessary fittings and desk to desk link brackets. It is recommended that full end frames are used at the end of runs.



Base Code	Description
CBL8	800mm Left hand
CBR8	800mm Right Hand

	Bench Desks	D3K Desks	EX10	X10	Design 2000 Cantilever	Design 2000 Panel End
	BK	GK	EP	KN	KV	KP
	£115	£115	£115	£115	£115	£115
	£115	£115	£115	£115	£115	£115

### Return Units

Supplied with a single endframe and fixing kit (desk not supplied).

Base Code	A	B
-----------	---	---

	Bench Desks	D3K Desks	EX10	X10	Design 2000 Cantilever	Design 2000 Panel End
	BK	GK	EP	KN	KV	KP
	£253	£269	£272	£272	£253	£253
	£237	£257	£265	£265	£237	£237

RD106	1000	600
RD086	800	600

MECT10*	£253	£269	£272	£272	£253	£253
MECT08*	£237	£257	£265	£265	£237	£237

\*For extended to rear of desk, use

MECT16 or MECT14 - depending upon length of return.



### Conference End Tables

Supplied with pillar legs & fixing brackets for all styles of frames.

Code	A	B	Price
SET16	1600	600	£730
SET12	1200	450	£691
FCE12	800	Ø1200	£730
FTE12	800	Ø1200	£730

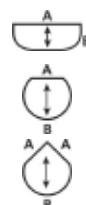



# DESKIT OVER DESK STORAGE DESKING

## Over Desk Storage

Fits to all **Deskit** standard desk models and can be retro fitted.  
For other desk compatibility, please contact our Sales Department.

Code	W	D	H	Price
FH16	1600	320	375	£253
FH14	1400	320	375	£228
FH12	1200	320	375	£212
FH10	1000	320	375	£195
FH08	800	320	375	£178
FH06	600	320	375	£171

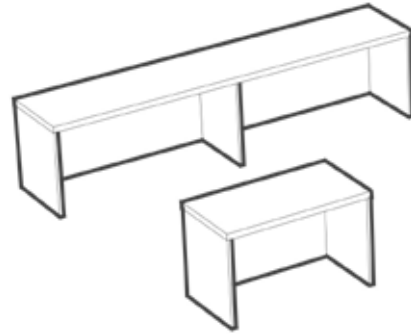

Example of use.

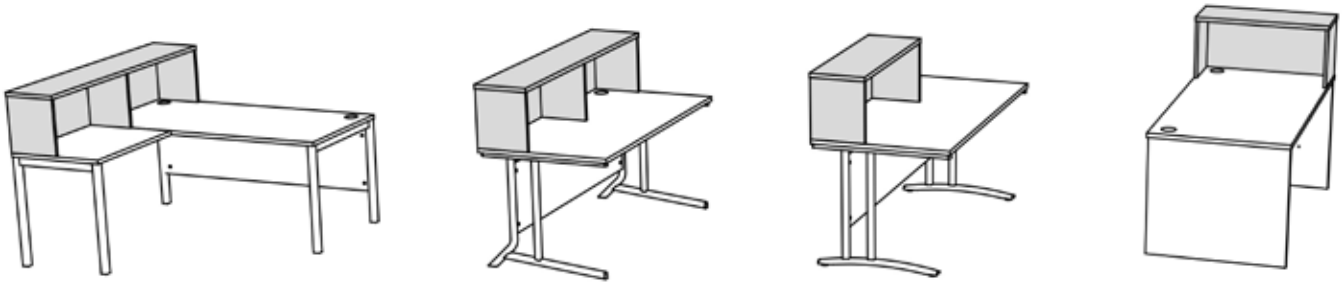

Design 2000 Deskit Rectangular Desk shown with optional Overdesk Storage

# HOME WORKER DESKING

2 Year  
Guarantee

Desking

With its hairpin leg design and integrated shelf space, this desk can be a nice addition to any home. With the shelf space offering an area to store those laptop and additional paperwork away to help keep your home feeling like a home when you have finished for the day.

## Features

- Choice of MFC Top finishes.
- Hair pin legs.
- Metal to metal fixings.
- Integrated shelf space (100mm).
- One person easy to assemble.

Code	W	D	H	Unit Price
<b>Rectangular Desk</b>				
HWK106Z	1000	x 600	x 800	£353
HWK126Z	1200	x 600	x 800	£366
HWK146Z	1400	x 600	x 800	£379





# HOME WORKER DESKING

Desking

Introducing into the Homeworke range is our new fold away desk. With space at a premium in some homes, this desk offers a neat alternative to the static desk. Once folded, the desk can be stored away to free up space. With its tool free assembly, the desk will fold and unfold instantly making it a simple but effective solution.

### Features

- Choice of MFC Top finishes
- Choice of frame colours
- Metal to metal fixings
- Folding desk for ease of storage
- One person tool free assembly
- Upper shelf

Code	W	D	H	Unit Price
<b>Rectangular Desk</b>				
EXHW12	1200	x 600	x 727/1200	£353
EXHW10	1000	x 600	x 727/1200	£366



# D3K FULLY WELDED DESKING

25 Year  
Structural  
Guarantee

Desking

- Fully Welded with stylish end frame that can accept cable management.
- Available with optional end frame covers.
- Available in a variety of desk and workstation footprints.
- Overall height 727mm with 25mm MFC tops.

Surcharge for Pastel Paint – £33 per item

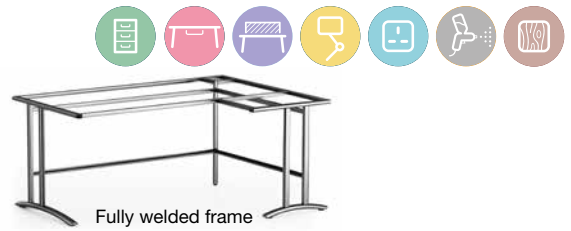

Code	A	B	C	Price
<b>800mm Deep Rectangular Desking</b> Can be used with tall under desk, under desk or desk high pedestals				
GDS18Z	1800	x	800	£609
GDS16Z	1600	x	800	£522
GDS14Z	1400	x	800	£492
GDS12Z	1200	x	800	£470
GDS10Z*	1000	x	800	£455
GDS08Z*	800	x	800	£441



Code	A	B	C	Price
<b>600mm Deep Rectangular Desking</b> Can be used with desk high pedestals.				
GDS186Z	1800	x	600	£557
GDS166Z	1600	x	600	£478
GDS146Z	1400	x	600	£450
GDS126Z	1200	x	600	£420
GDS106Z	1000	x	600	£412
GDS086Z	800	x	600	£391



Code	A	B	C	Price
<b>Right Hand Wave Desking</b> Can be used with tall under desk, under desk or desk high pedestals on 800mm side only.				
GDWR18Z	1800	x	800 x 1000	£691
GDWR16Z	1600	x	800 x 1000	£609
GDWR14Z	1400	x	800 x 1000	£575
GDWR12Z	1200	x	800 x 1000	£553



Code	A	B	C	Price
<b>Left Hand Wave Desking</b> Can be used with tall under desk, under desk or desk high pedestals on 800mm side only.				
GDWL18Z	1800	x	800 x 1000	£691
GDWL16Z	1600	x	800 x 1000	£609
GDWL14Z	1400	x	800 x 1000	£575
GDWL12Z	1200	x	800 x 1000	£553



Code	A	B	C	Price
<b>Right Hand Consult Desking</b> Can be used with tall under desk, under desk or desk high pedestals on 800mm side only.				
GCDR21Z	2100	x	800 x ø1000	£702
GCDR19Z	1900	x	800 x ø1000	£651
GCDR17Z	1700	x	800 x ø1000	£617

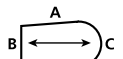

Code	A	B	C	Price
<b>Left Hand Consult Desking</b> Can be used with tall under desk, under desk or desk high pedestals on 800mm side only.				
GCDL21Z	2100	x	800 x ø1000	£702
GCDL19Z	1900	x	800 x ø1000	£651
GCDL17Z	1700	x	800 x ø1000	£617

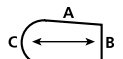

Code	A	B	C	Price
<b>Double Wave Desking</b> Can be used with under desk or tall under desk pedestals.				
GDWD18Z	1800	x	800 x 1000	£691
GDWD16Z	1600	x	800 x 1000	£609



Code	A	B	C	Price
<b>Conference End Tables</b>				
Circular				
GCCE12Z	800	x	ø1200	£653
Tear Drop				
GCTE12Z	800	x	ø1200	£737
Semi-Circular				
GSCT16Z	800	x	ø1600	£704
GSCT12Z	600	x	ø1200	£653

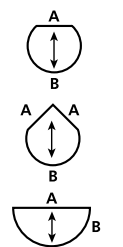

Code	W	D	H	Price
<b>Accessories</b>				
<b>Mobile Lectern &amp; Trolley.</b>				
GLZ	690	x	720 x 1170	£937
Angled work surface. (Top size 590w x 560d)				
GPCSZ	590	x	800 x 1000	£1,096
CPU holder and rear monitor shield included.				
GDDL				£14
Desk to Desk Link Bracket				



GLZ



GPCSZ



Code	A	B	C	D	Price
<b>Right Hand Universal Workstations</b> Can be used with under desk, tall under desk or desk high pedestals.					
GUWSR18Z	1800	x 800	x 600	x 1200	£878
GUWSR16Z	1600	x 800	x 600	x 1200	£844
GUWSR14Z	1400	x 800	x 600	x 1200	£811

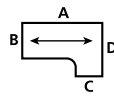

Code	A	B	C	D	Price
<b>Right Hand Consult Workstations</b> Can be used with under desk, tall under desk or desk high pedestals.					
GCWSR22Z	2200	x 800	x 600	x 1200	£1,095
GCWSR20Z	2000	x 800	x 600	x 1200	£1,041
GCWSR18Z	1800	x 800	x 600	x 1200	£991

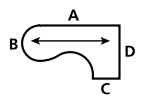

<b>Left Hand Universal Workstations</b> Can be used with under desk, tall under desk or desk high pedestals.					
GUWSL18Z	1800	x 800	x 600	x 1200	£878
GUWSL16Z	1600	x 800	x 600	x 1200	£844
GUWSL14Z	1400	x 800	x 600	x 1200	£811

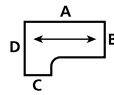

<b>Left Hand Consult Workstations</b> Can be used with under desk, tall under desk or desk high pedestals.					
GCWSL22Z	2200	x 800	x 600	x 1200	£1,095
GCWSL20Z	2000	x 800	x 600	x 1200	£1,041
GCWSL18Z	1800	x 800	x 600	x 1200	£991

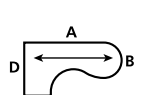

<b>Symmetrical Workstations</b> Can be used with under desk, tall under desk or desk high pedestals. *Except 600 x 600mm					
GUWSR18Z	1600	x 800	x 600	x 1200	£913
GUWSR16Z	1400	x 800	x 600	x 1200	£858
GUWSR14Z	1200	x 800	x 600	x 1200	£710
GWS126SZ*	1200	x 800	x 600	x 1200	£710

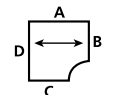

<b>120° Workstations</b> Can be used with under desk, tall under desk or desk high pedestals. *Except 600 x 600mm					
GDY128Z	1200	x 800	x 800	x 1200	£784
GDY126Z*	1200	x 600	x 600	x 1200	£784
GDY106Z*	1000	x 600	x 600	x 1200	£739

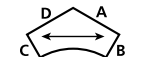

**GOF Desk Top Screen Bracket Information**  
Please refer to our Screens & Pods Section for GOF desk top screens.

\* Requires link post

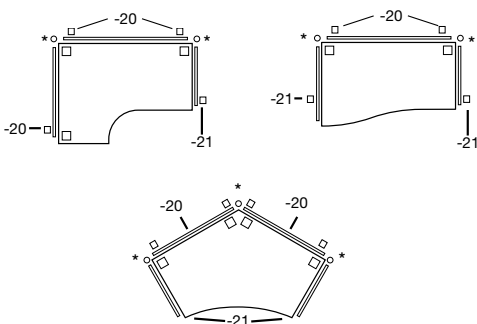

# DESIGN 2000 FULLY WELDED DESKING

25 Year  
Structural  
Guarantee

Desking

- Our most sustainable Desk for over 40 years.
  - Extensive range including Rectangular Desks, Workstations and Wave Desks.
  - Continuous welded underframe for heavy duty environments.
  - Available with optional cable management and end frame covers.
- Overall height 727mm with 25mm MFC tops.



Surcharge for Pastel Paint – £33 per item

Code	A	B	C	Price
------	---	---	---	-------

### 800mm Deep Rectangular Desking

Can be used with tall under desk, under desk or desk high pedestals.

VD728Z	1800	800		£558
VD638Z	1600	800		£480
VD568Z	1400	800		£452
VD488Z	1200	800		£432
VD408Z*	1000	800		£419
VD318Z*	800	800		£407

### 600mm Deep Rectangular Desking

Can be used with desk high pedestals.

VD726Z	1800	600		£505
VD636Z	1600	600		£438
VD566Z	1400	600		£412
VD486Z	1200	600		£389
VD406Z	1000	600		£385
VD316Z	800	600		£368

### Right Hand Wave Desking

Can be used with tall under desk, under desk or desk high pedestals on 800mm side only.

8DWR18Z	1800	800	1000	£634
8DWR16Z	1600	800	1000	£558
8DWR14Z	1400	800	1000	£529
8DWR12Z	1200	800	1000	£509

### Left Hand Wave Desking

Can be used with tall under desk, under desk or desk high pedestals on 800mm side only.

8DWL18Z	1800	800	1000	£634
8DWL16Z	1600	800	1000	£558
8DWL14Z	1400	800	1000	£529
8DWL12Z	1200	800	1000	£509

### GOF Desk Top Screen Bracket Information

Please refer to our Screens & Pods Section for GOF desk top screens (Not available on Wire Managed Desks).

\* Requires link post

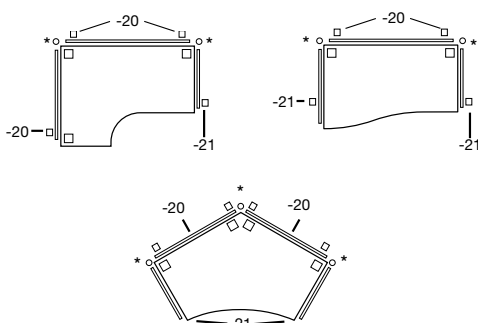

Code	A	B	C	Price
------	---	---	---	-------

### Right Hand D-End Desking

Can be used with tall under desk, under desk or desk high pedestals.

VD798RDZ	2000	800		£665
VD728RDZ	1800	800		£604
VD638RDZ	1600	800		£526

### Left Hand D-End Desking

Can be used with tall under desk, under desk or desk high pedestals.

VD798LDZ	2000	800		£665
VD728LDZ	1800	800		£604
VD638LDZ	1600	800		£526

### Double Wave Desking

Can be used with under desk or tall under desk pedestals.

8DWD18Z	1800	800	1000	£622
8DWD16Z	1600	800	1000	£547

Code	A	B	C	D	Price
------	---	---	---	---	-------

### Right Hand Universal Workstations

Can be used with under desk, tall under desk or desk high pedestals.

UWS18RZ	1800	800	600	1200	£868
UWS16RZ	1600	800	600	1200	£821
UWS14RZ	1400	800	600	1200	£787
UWS188RZ	1800	800	800	1200	£937
UWS168RZ	1600	800	800	1200	£887

### Left Hand Universal Workstations

Can be used with under desk, tall under desk or desk high pedestals.

UWS18LZ	1800	800	600	1200	£868
UWS16LZ	1600	800	600	1200	£821
UWS14LZ	1400	800	600	1200	£787
UWS188LZ	1800	800	800	1200	£937
UWS168LZ	1600	800	800	1200	£887

### Symmetrical Workstations

Can be used with under desk, tall under desk or desk high pedestals. \*Except 600 x 600mm

UWS16SZ	1600	800	800	1600	£891
UWS14SZ	1400	800	800	1400	£836
UWS12SZ	1200	800	800	1200	£721
UWS126SZ*	1200	600	600	1200	£721

### Design 2000 Cantilever Cut Back Legs

8CBR	Right Hand	Any 800d Desk or 800 side of Workstation	£115
8CBL	Left Hand	Any 800d Desk or 800 side of Workstation	£115

25 Year  
Structural  
Guarantee

# DESIGN 2000 FULLY WELDED DESKING

Desking



# MODULAR RECEPTION UNITS DESKING

10 Year  
Guarantee

Desking





Our comprehensive range of modular units provides you with almost unlimited configurations to create the footprint for any reception environment.

- Multiple choice of units
- DDA compliant base units
- Vast range of board finishes
- Compatible to our wide range of furniture
- Glass shelf options

Please contact Sales for more information...  
We can aid your planning and provide a suitable proposal and quotation.

**Now available in all standard MFC finishes.**

## How to Order Units

### Leg Positions

Base units are available with either full or cutback panel ends. Full panels are always required on the outside edge.

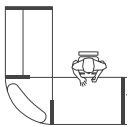

Cut back panels specified at joint. Full panels are required on the outside edge.



Full panels are required when joining to DDA units.

### Cable ports - suffix code (-p)

Units are priced without cable ports.  
If required, suffix code with (-P) and state cable ports required.  
Cost addition of £96 Retail per unit.



### Footprints Explanation

Straight or curved options are available to accommodate space planning requirements.

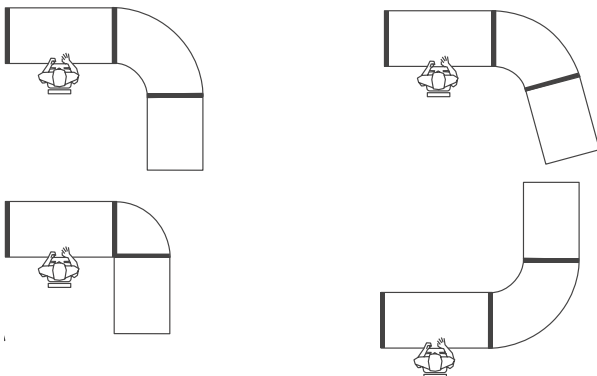

## Important Information

Reception units are made to order and the lead-time to supply these goods will reflect this. Special products are not available.

### Modular Panel End Units Containing:

interchangeable base, top & counter units. Base units can be specified with cut back panels providing clear legroom when adjacent modules are linked. This flexible collection can cater for a variety of front-office requirements whilst offering a robust structure and cost effective solution.

### All Modules Have:

25mm tops and end panels finished with high impact resistant edging.

### Key Features:

- Ease of identifying, specifying & ordering modules.
- Ease of installation - either tool-free or with use of standard Allen key.
- Base units supplied with steel kick plates.
- Optional cable management.
- Optional third level accessories.
- Base units are 750 tall to allow 700 clearance for DDA compliance.
- Base units supplied with shelf unless stated.

### PLEASE NOTE:

UNDER DESK PEDESTALS WILL PROTRUDE BY APPROX 100MM.

## Design and Manufacture

Designed and Manufactured to conform to

BS EN 527-1:2000  
Office furniture, work tables and desk dimensions.

BS EN 527-2:2002  
Test methods for the determination of stability.

BS EN 527-3:2003  
Test methods for the determination of strength.

BS 3044:1990  
Ergonomics principles in the design and selection of office furniture.

BS EN ISO 9241-5: 1999  
Ergonomic requirements for office work with visual display terminals.

BS 8300: 2001  
Design of buildings and their approaches to meet the needs of disabled people - Code of practice. (DDA compliance).

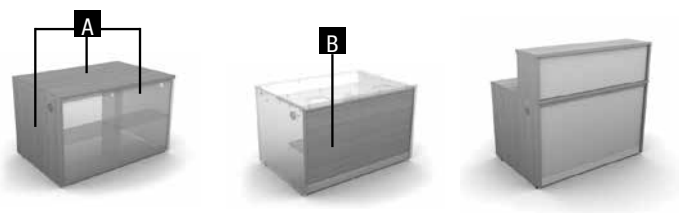

**A** Select end and top finish from MFC colours.

**B** Silver and White front finish on straight and curved units.

# MODULAR RECEPTION UNITS DESKING

10 Year  
Guarantee

Desking



Full panel



Cut back right panel



Cut back left panel



Cut back left & right panel

Code                      A                      B                      C                      Price



Straight base unit - full panel

ASB16FF	1600	x	800		£1,558
ASB14FF	1400	x	800		£1,450
ASB12FF	1200	x	800		£1,339
ASB10FF	1000	x	800		£1,224
ASB08FF	800	x	800		£1,117



Straight base unit - cut back left & right panels

ASB16II	1600	x	800		£1,558
ASB14II	1400	x	800		£1,450
ASB12II	1200	x	800		£1,339
ASB10II	1000	x	800		£1,224
ASB08II	800	x	800		£1,117

Code                      A                      B                      C                      Price



Straight base unit - cut back right hand panel

ASB16FIR	1600	x	800		£1,558
ASB14FIR	1400	x	800		£1,450
ASB12FIR	1200	x	800		£1,339
ASB10FIR	1000	x	800		£1,224
ASB08FIR	800	x	800		£1,117



Straight base unit - cut back left hand panel

ASB16FIL	1600	x	800		£1,558
ASB14FIL	1400	x	800		£1,450
ASB12FIL	1200	x	800		£1,339
ASB10FIL	1000	x	800		£1,224
ASB08FIL	800	x	800		£1,117



Full panel



Cut back right panel



Cut back left panel



Cut back left & right panel



Radial base unit - full panel

90° ARB90FF	1838	x	800	x	1300	£1,883
60° ARB60FF	1300	x	800	x	1300	£1,859



Radial base unit - cut back left & right panels

90° ARB90II	1838	x	800	x	1300	£1,883
60° ARB60II	1300	x	800	x	1300	£1,859



Radial base unit - cut back right hand panel

90° ARB90FIR	1838	x	800	x	1300	£1,883
60° ARB60FIR	1300	x	800	x	1300	£1,859



Radial base unit - cut back left hand panel

90° ARB90FIL	1838	x	800	x	1300	£1,883
60° ARB60FIL	1300	x	800	x	1300	£1,859



Cut back right panel



Cut back left panel



Cut back left & right panel



Corner unit - cut back right hand panel  
Unit supplied without shelf.

90° ARB00FIR	1131	x	800	x	800	£1,839
--------------	------	---	-----	---	-----	--------



Corner unit - cut back left hand panel  
Unit supplied without shelf.

90° ARB00FIL	1131	x	800	x	800	£1,839
--------------	------	---	-----	---	-----	--------



Corner unit - cut back right & left hand panel  
Unit supplied without shelf.

90° ARB00II	1131	x	800	x	800	£1,839
-------------	------	---	-----	---	-----	--------

# MODULAR RECEPTION UNITS DESKING





Radial inverted base unit



Radial DDA base unit



Straight DDA base unit

Code	A	B	C	Price
 <p>Radial inverted base unit</p>				
90° AIRB90FF	1838	x 800	x 1300	£1,883
60° AIRB60FF	1300	x 800	x 1300	£1,859
 <p>Radial DDA base unit supplied without shelf.</p>				
90° ARD90	1838	x 800	x 1300	£1,661
60° ARD60	1300	x 800	x 1300	£1,634

Code	A	B	C	Price
 <p>Straight DDA base unit supplied without shelf.</p>				
ASD16	1600	x 800		£1,558
ASD14	1400	x 800		£1,450
ASD12	1200	x 800		£1,322
ASD10	1000	x 800		£1,224
ASD08	800	x 800		£1,116



Full panel



Cut back right hand panel





Cut back left hand panel



Cut back left & right hand panel

Code	A	B	Price
 <p>Straight base unit with wooden file hutch - full panel supplied as complete unit, file hutches are 300mm deep x 355mm high.</p>			
AST16FF	1600	x 800	£2,299
AST14FF	1400	x 800	£2,156
AST12FF	1200	x 800	£2,007
AST10FF	1000	x 800	£1,862
AST08FF	800	x 800	£1,722

Code	A	B	Price
 <p>Straight base unit with wooden file hutch - cut back right hand panel supplied as complete unit, file hutches are 300mm deep x 355mm high.</p>			
AST16FIR	1600	x 800	£2,299
AST14FIR	1400	x 800	£2,156
AST12FIR	1200	x 800	£2,007
AST10FIR	1000	x 800	£1,862
AST08FIR	800	x 800	£1,722

Code	A	B	Price
 <p>Straight base unit with wooden file hutch - cut back left hand panel supplied as complete unit, file hutches are 300mm deep x 355mm high.</p>			
AST16FIL	1600	x 800	£2,299
AST14FIL	1400	x 800	£2,156
AST12FIL	1200	x 800	£2,007
AST10FIL	1000	x 800	£1,862
AST08FIL	800	x 800	£1,722

Code	A	B	Price
 <p>Straight base unit with wooden file hutch - cut back left &amp; right hand panels supplied as complete unit, file hutches are 300mm deep x 355mm high.</p>			
AST16FII	1600	x 800	£2,299
AST14FII	1400	x 800	£2,156
AST12FII	1200	x 800	£2,007
AST10FII	1000	x 800	£1,862
AST08FII	800	x 800	£1,722



Full panel



Cut back right hand panel





Cut back left hand panel



Cut back left & right hand panel

Code	A	B	Price
 <p>Straight base unit with wooden counter top - full panel wooden counter top height - 1035mm.</p>			
ASW16FF	1600	x 800	£1,704
ASW14FF	1400	x 800	£1,601
ASW12FF	1200	x 800	£1,491
ASW10FF	1000	x 800	£1,376
ASW08FF	800	x 800	£1,268

Code	A	B	Price
 <p>Straight base unit with wooden counter top - cut back right hand panel wooden counter top height - 1035mm.</p>			
ASW16FIR	1600	x 800	£1,704
ASW14FIR	1400	x 800	£1,601
ASW12FIR	1200	x 800	£1,491
ASW10FIR	1000	x 800	£1,376
ASW08FIR	800	x 800	£1,268

Code	A	B	Price
 <p>Straight base unit with wooden counter top - cut back left hand panel wooden counter top height - 1035mm.</p>			
ASW16FIL	1600	x 800	£1,704
ASW14FIL	1400	x 800	£1,601
ASW12FIL	1200	x 800	£1,491
ASW10FIL	1000	x 800	£1,376
ASW08FIL	800	x 800	£1,268

Code	A	B	Price
 <p>Straight base unit with wooden counter top - cut back left &amp; right hand panels wooden counter top height - 1035mm.</p>			
ASW16II	1600	x 800	£1,704
ASW14II	1400	x 800	£1,601
ASW12II	1200	x 800	£1,491
ASW10II	1000	x 800	£1,376
ASW08II	800	x 800	£1,268

# MODULAR RECEPTION UNITS DESKING

10 Year  
Guarantee

Desking



Full panel



Cut back right hand panel



Cut back left hand panel



Cut back left & right hand panel



**Straight base unit with glass counter top - full panel**  
glass counter top height - 1025mm.

ASG16FF	1600	x	800		£2,781
ASG14FF	1400	x	800		£2,668
ASG12FF	1200	x	800		£2,555
ASG10FF	1000	x	800		£2,444
ASG08FF	800	x	800		£2,329



**Straight base unit with glass counter top - cut back right hand panel**  
glass counter top height - 1025mm.

ASG16FIR	1600	x	800		£2,781
ASG14FIR	1400	x	800		£2,668
ASG12FIR	1200	x	800		£2,555
ASG10FIR	1000	x	800		£2,444
ASG08FIR	800	x	800		£2,329



**Straight base unit with glass counter top - cut back left hand panel**  
glass counter top height - 1025mm.

ASG16FIL	1600	x	800		£2,781
ASG14FIL	1400	x	800		£2,668
ASG12FIL	1200	x	800		£2,555
ASG10FIL	1000	x	800		£2,444
ASG08FIL	800	x	800		£2,329



**Straight base unit with glass counter top - cut back left & right hand panels**  
glass counter top height - 1025mm.

ASG16FII	1600	x	800		£2,781
ASG14FII	1400	x	800		£2,668
ASG12FII	1200	x	800		£2,555
ASG10FII	1000	x	800		£2,444
ASG08FII	800	x	800		£2,329



Cut back right hand panel



Cut back left hand panel



Cut back left & right hand panel



**Corner unit with wooden counter top - cut back right hand panel**  
supplied without shelf

90° ARW00FIR	1131	x	800	x	800	£2,246
--------------	------	---	-----	---	-----	--------



**Corner unit with wooden counter top - cut back left & right hand panel**  
supplied without shelf.

90° ARW00FII	1131	x	800	x	800	£2,246
--------------	------	---	-----	---	-----	--------



**Corner unit with wooden counter top - cut back left hand panel**  
supplied without shelf

90° ARW00FIL	1131	x	800	x	800	£2,246
--------------	------	---	-----	---	-----	--------



# MODULAR RECEPTION UNITS DESKING



Full panel



Cut back right hand panel





Cut back left hand panel



Cut back left & right hand panel

Code	A	B	C	Price		
 Radial base unit with wooden counter top - full panel wooden counter top height - 1035mm.						
90° ARW90FF	1838	x	800	x	1300	£2,291
60° ARW60FF	1300	x	800	x	1300	£2,270

Code	A	B	C	Price		
 Radial base unit with wooden counter top - cut back right hand panel wooden counter top height - 1035mm.						
90° ARW90FIR	1838	x	800	x	1300	£2,291
60° ARW60FIR	1300	x	800	x	1300	£2,270

Code	A	B	C	Price		
 Radial base unit with wooden counter top - cut back left hand panel wooden counter top height - 1035mm.						
90° ARW90FIL	1838	x	800	x	1300	£2,291
60° ARW60FIL	1300	x	800	x	1300	£2,270

Code	A	B	C	Price		
 Radial base unit with wooden counter top - cut back left & right hand panels wooden counter top height - 1035mm.						
90° ARW90II	1838	x	800	x	1300	£2,291
60° ARW60II	1300	x	800	x	1300	£2,270



Full panel



Cut back right hand panel





Cut back left hand panel



Cut back left & right hand panel

Code	A	B	C	Price		
 Radial base unit with glass counter top - full panel glass counter top height - 1025mm						
90° ARG90FF	1838	x	800	x	1300	£3,099
60° ARG60FF	1300	x	800	x	1300	£3,040

Code	A	B	C	Price		
 Radial base unit with glass counter top - cut back right hand panel glass counter top height - 1025mm						
90° ARG90FIR	1838	x	800	x	1300	£3,099
60° ARG60FIR	1300	x	800	x	1300	£3,040

Code	A	B	C	Price		
 Radial base unit with glass counter top - cut back left hand panel glass counter top height - 1025mm.						
90° ARG90FIL	1838	x	800	x	1300	£3,099
60° ARG60FIL	1300	x	800	x	1300	£3,040

Code	A	B	C	Price		
 Radial base unit with glass counter top - cut back left & right hand panel glass counter top height - 1025mm.						
90° ARG90FF	1838	x	800	x	1300	£3,099
60° ARG60FF	1300	x	800	x	1300	£3,040



Cut back right hand panel





Cut back left hand panel



Cut back left & right hand panel

Code	A	B	C	Price		
 Corner unit with glass counter top - cut back right hand panel supplied without shelf.						
90° ARG00FIR	1131	x	800	x	800	£2,451

Code	A	B	C	Price		
 Corner unit with glass counter top - cut back left & right hand panel supplied without shelf.						
90° ARG00II	1131	x	800	x	800	£2,451

Code	A	B	C	Price		
 Corner unit with glass counter top - cut back left hand panel supplied without shelf.						
90° ARG00FIL	1131	x	800	x	800	£2,451

# CABLE MANAGEMENT DESKING

## Universal Cable Management

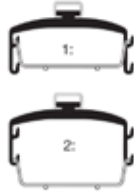
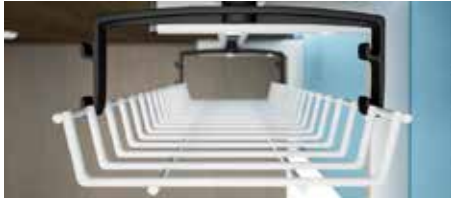

Cable Baskets can fit on suspension brackets in two positions.

1. To accommodate tall under desk pedestals under tray.
2. To accommodate transformer plugs in tray.

Baskets can be unhooked from suspension brackets on one side to provide easy access to cables and modules.

Code	Desk Size	L	W	Price
------	-----------	---	---	-------

### Cable Baskets for single sided desks

MECT20	2000	1832	116	£92
MECT18	1800	1629	116	£90
MECT16	1600	1426	116	£86
MECT14	1400	1222	116	£85
MECT12	1200	1019	116	£79
MECT10	1000	816	116	£76
MECT08	800	612	116	£74

Code	Desk Size	L	W	Price
------	-----------	---	---	-------

### Cable Baskets for double sided desks

MECT20D	2000	1832	336	£138
MECT18D	1800	1629	336	£134
MECT16D	1600	1426	336	£127
MECT14D	1400	1222	336	£126
MECT12D	1200	1019	336	£119
MECT10D	1000	816	336	£114
MECT08D	800	612	336	£112

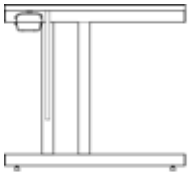

Cable basket fitting (Desklet cantilever and panel ended desks)

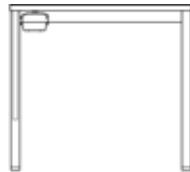

Cable basket fitting (Bench Desklet desks)

## Desklet Endframe Covers



### Outer Covers

Where Used

RH 800mm Endframe  
LH 800mm Endframe  
RH 600mm Endframe  
LH 600mm Endframe

	D3K Desklets	X10	Design 2000 Cantilever	Price
GRECR	KNRECR	8ECR	£42	
GLECR	KNLECR	8ECR	£42	
GSECR	KNRECR	8ECR	£42	
GSECR	KNRECR	8ECR	£42	

### Inner Covers

Description

Inner cover, cable restraints & plastic cable trunking inc. Requires outer covers for fitting.

	D3K Desklets	X10	Design 2000 Cantilever	Price
GERI	KNERI	8ERI	£42	

### Cable Spine

ø60 x 700h

Code	Colour	Price
BCRB	Black	£86
BCRS	Silver	£86
BCRW	White	£86



Design 2000 Desklet Outer Cover



X10 Desklet Outer Cover



D3K Desklet Outer Cover

# ELECTRICAL INSTALLATION GUIDE

## DESKING

### Electrical Installations within Office Furniture, Educational Furniture and Office Screens

This information is intended to help when specifying power distribution systems in furniture and is based on BS 6396: 2008 + A1 2015. Please refer to this standard for more information. It is recommended that all installations be completed by a suitably skilled person and that all equipment meets the pertinent standard criteria.

Examples shown are based on single-phase electrical distribution system with rated voltages up to 250 V a.c. connected to the building's supply by a 13A UK plug, conforming to BS 1363.

#### Under Desk Modules

When individually fused at **5 A max.**, no more than four sockets can be connected to a 13A single supply lead. These can be made-up of single 4-gang modules or 2-gang units connected with a lead.

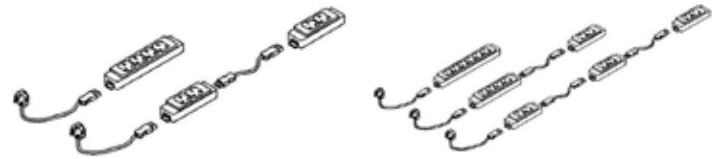

When individually fused at **3.15 A max.**, no more than six sockets can be connected to a 13A single supply lead. These can be made-up of single 6-gang modules, 4-gang or 2-gang units connected with leads.

#### Under and On Desk Modules

When individually fused at **5 A max.**, no more than four sockets can be connected to a 13A single supply lead. These can be made-up of single 4-gang modules or 2-gang units connected with leads.

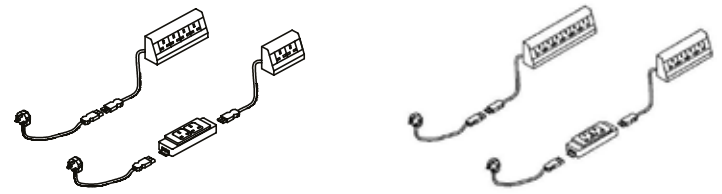

When individually fused at **3.15 A max.**, no more than six sockets can be connected to a 13A single supply lead. These can be made-up of single 6-gang modules, 4-gang or 2-gang units connected with leads and connector blocks.

Under desk modules that are fitted with data outlets cannot be interconnected.

#### Through-Desk Modules

When including UK power sockets, follow the same rules as under and on-desk outlets. Consideration should also be given to the overall cost. If there are enough sockets for the starter cables, then it may be simpler and more cost effective to use starter leads than connecting to a single starter cable using connector leads and blocks.

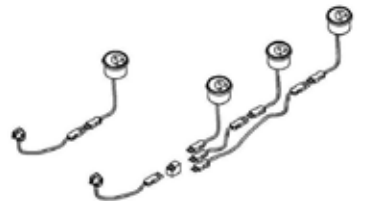

#### USB Charging Modules

These units only provide a fraction of the current compared to UK power sockets and when used separately from other outlets can be 'daisy-chained' together to a maximum of **60 No. units** from one starter lead, connector leads and blocks. Best practice is to reduce the amount of connectors where possible.

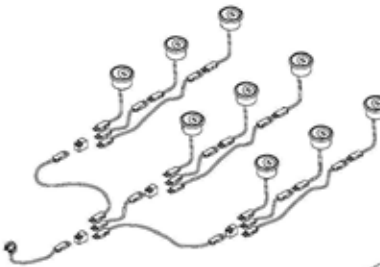

On selected modules, twin USB fast charge now consist of a USB-A and a USB-C socket. The USB Type C connector is now being adopted by all the major manufacturers of mobile devices (phones, tablets, etc) and has already been incorporated into some laptops. This is not only because of its small form factor and the fact that it is reversible, making it simpler and easier to use, but also because it enables significantly faster charging than was possible with the USB Type A connector, whilst at the same time (for relevant devices) replacing all former AV/data connections, such as VGA, HDMI, USB-A, RJ45.

Where shown, modules with a twin USB outlet will provide both the new USB-C port, for enhanced fast charging of compatible devices, plus a USB-A for charging legacy devices - suiting users with any USB powered device old. ® Denotes new style reversible Type A & Type C fast charge with replaceable cartridge.

#### Exposed Power Cables

When all the outlets are connected and the Starter Cable is plugged into a power supply, any exposed length of supply cord must not exceed **2 metres** in length.

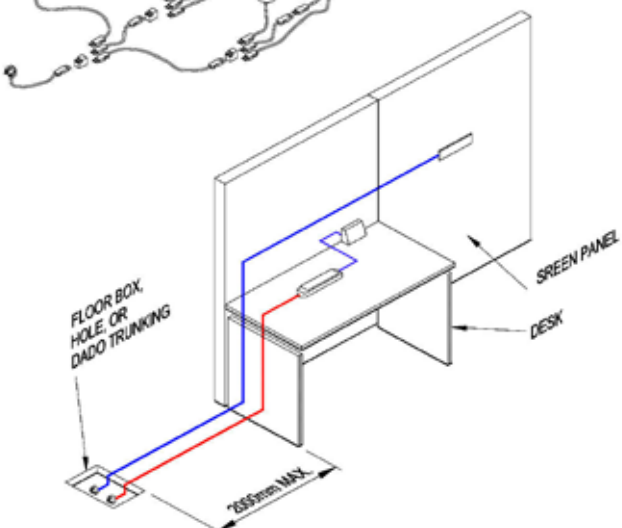

# ELECTRICAL ACCESSORIES

## DESKING

### On and In Desk Modules

All on-desk or in-desk modules containing electrical outlets are supplied with a short lead to a male Wieland GST plug. These can be connected to an under-desk module, a connector lead / block or a starter cable – sold separately. Data modules, including RJ45, HDMI & data USB are hardwired to a 3 metre lead fitted with an appropriate connector.

### Under Desk Modules

All under desk modules require a connector lead or a starter cable.

Please check with our Sales Department for fitting Power Modules to Bench Desksits.

### Safe Electrical Wiring

For all types of power modules, please refer to the installation guidelines.

### Where Used

The icons shown indicate where modules can be used:



Desks



Tables



Seating

### Outlet Types/Quantities



UK POWER



CAT 5e DATA



CAT 6 DATA



TWIN USB FAST CHARGE

### Code

Code	UK POWER	CAT 5e DATA	CAT 6 DATA	TWIN USB FAST CHARGE	Price
DTPMX-10	2	1	-	-	£135
DTPMX-20	2	-	1	-	£147
DTPMX-30	2	2	-	-	£166
DTPMX-40	2	-	2	-	£195
DTPMX-50	4	2	-	-	£198
DTPMX-60	4	-	2	-	£230
DTPMX-70	2	-	-	1	£211
DTPMX4	4	-	-	-	£154
DTPMX	2	-	-	-	£121

Available in White finish

### Cut-Outs - Required in worksurface to fit module

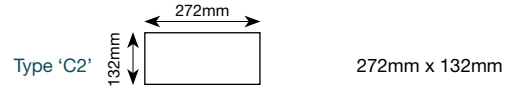
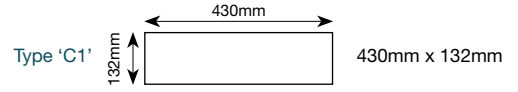



# ELECTRICAL ACCESSORIES DESKING

Code	Outlet Types/Quantities				Cut out	Price
	UK POWER	CAT 5e DATA	CAT 6 DATA	TWIN USB FAST CHARGE		
DTPX	1	-	-	-	P	£157
DTPX02U	-	-	-	1	P	£258
DTPXD5	1	1	-	-	P	£229
DTPXD6	1	-	1	-	P	£230
DTPXH	1	-	-	-	P	£386
DTPXT	1	-	-	1	P	£315
DTPX-10	1	2	-	-	P	£249
DTPX-20	1	-	2	-	P	£332
DTPX-30	-	2	-	1	P	£347
DTPX-40	-	-	2	1	P	£432
DTPX-50	1	1	-	-	P	£438
DTPX-60	1	-	1	-	P	£477

Available in Silver surround with Black or White fascia



Code	Outlet Types/Quantities				Cut out	Price
	UK POWER	CAT 5e DATA	CAT 6 DATA	TWIN USB FAST CHARGE		
DTPPT03	3	-	-	-	P	£271
DTPPT02U	2	-	-	1	P	£377
DTPPT02D5	2	2	-	-	P	£343
DTPPT02D6	2	-	2	-	P	£452
DTPPT-10	1	2	-	1	P	£468
DTPPT-20	1	-	2	1	P	£530

Available in White or Black finish.



# ELECTRICAL ACCESSORIES

## DESKING

Desking

Code	Outlet Types/Quantities							Cut Out	Price
	UK POWER	CAT 5e DATA	CAT 6 DATA	TWIN USB FAST CHARGE® 1x USB-A 1x USB-C	VGA & AUDIO	HDMI	SINGLE USB DATA		
DTPLA-10	2	-	-	-	-	-	-	C3	£302
DTPLA-20	2	1	-	-	-	-	-	C2	£374
DTPLA-30	2	-	1	-	-	-	-	C2	£389
DTPLA-40	2	2	-	1	-	-	-	C2	£534
DTPLA-50	2	-	2	1	-	-	-	C2	£627
DTPLA-60	4	-	-	-	-	-	-	C1	£426
DTPLA-70	2	2	-	-	1	1	-	C1	£1,028
DTPLA-80	2	-	2	-	1	1	-	C1	£1,118
DTPLA-90	4	2	-	-	-	-	-	C1	£522
DTPLA-100	4	-	2	-	-	-	-	C1	£610
DTPLA-110	4	2	-	-	1	-	-	C1	£920
DTPLA-120	4	-	2	-	1	-	-	C1	£1,005
DTPLA-130	4	4	-	-	-	-	-	C1	£628
DTPLA-140	4	-	4	-	-	-	-	C1	£802
DTPLA-150	2	2	-	-	1	-	-	C2	£796
DTPLA-160	2	-	2	-	1	-	-	C2	£887
DTPLA-170	2	2	-	1	1	1	-	C1	£1,166
DTPLA-180	2	-	2	1	1	1	-	C1	£1,252
DTPLA-190	2	2	-	-	1	2	-	C1	£1,182
DTPLA-200	3	-	-	-	1	1	-	C1	£940
DTPLA-210	2	1	-	-	-	1	-	C2	£666
DTPLA-220	3	1	-	-	-	1	-	C1	£761
DTPLA-230	3	-	1	-	-	1	-	C1	£804
DTPLA-240	3	-	2	-	1	1	-	C1	£1,084
DTPLA-250	4	2	-	-	-	1	-	C1	£836
DTPLA-260	4	-	2	-	-	2	-	C1	£1,084
DTPLA-270	3	1	-	-	-	-	-	C1	£443
DTPLA-280	2	4	-	-	-	1	1	C1	£942
DTPLA-290	2	2	-	-	-	1	-	C2	£720
DTPLA-300	1	1	-	-	1	1	2	C1	£1,047
DTPLA-310	2	2	-	-	1	1	2	C1	£1,130
DTPLA-320	2	-	-	-	1	1	-	C2	£850
DTPLA-330	3	-	-	-	-	-	-	C2	£323
DTPLA-340	2	-	-	-	-	1	1	C2	£648
DTPLA-350	1	1	-	-	1	1	-	C2	£859
DTPLA-360	2	2	-	-	1	1	1	C1	£1,077
DTPLA-370	2	-	-	1	-	1	-	C2	£748
DTPLA02U	2	-	-	1	-	-	-	C2	£440
DTPLA02D5	2	2	-	-	-	-	-	C2	£384
DTPLA02D6	2	-	2	-	-	-	-	C2	£448
DTPLA01VA	2	-	-	-	1	-	-	C2	£658
DTPLA02H	2	-	-	-	-	-	2	C2	£854



Available in Silver finish.

### Examples

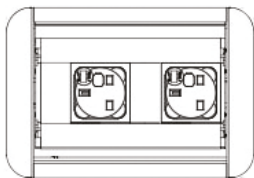

DTPLA-10

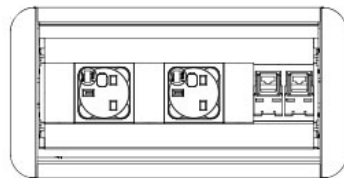

DTPLA02D5

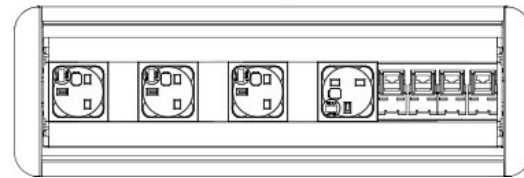

DTPLA-130

Code	Outlet Types/Quantities			Price
	UK POWER	CAT 6 DATA	TWIN USB FAST CHARGE 1x USB-A 1x USB-C	
DTPUNO-10	2	-	1	£218
DTPUNO-20	2	*2	1	£278



Modules are available in either Black or White  
Units have illuminated switches and fitted with an integrated thermal reset switch instead of fuses.  
\* Data modules are supplied as coupler to allow for separate patch lead (not supplied)

# ELECTRICAL ACCESSORIES

## DESKING

**Outlet Types/Quantities**

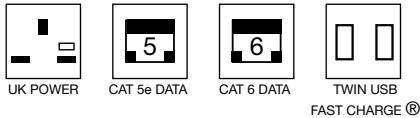

Code	UK POWER	CAT 5e DATA	CAT 6 DATA	TWIN USB FAST CHARGE <sup>®</sup>	Price
DTPMP	2	-	-	-	£214
DTPMP4	4	-	-	-	£285
DTPMP-10	2	-	-	1	£397
DTPMP-20	2	2	-	-	£355
DTPMP-30	2	-	2	-	£441
DTPMP-40	1	2	-	1	£462
DTPMP-50	1	-	2	1	£545
DTPMP-60	1	-	-	1	£342
DTPMP-70	2	2	-	1	£497
DTPMP-80	2	-	2	1	£579



Available in White or Black finish.

**Outlet Types/Quantities**

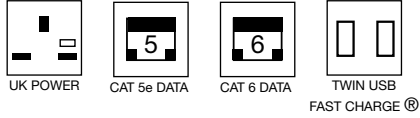

Code	UK POWER	CAT 5e DATA	CAT 6 DATA	TWIN USB FAST CHARGE <sup>®</sup>	Price
DTPMS	2	-	-	-	£134
DTPMS4	4	-	-	-	£193
DTPMS-10	2	-	-	1	£300
DTPMS-20	2	2	-	-	£238
DTPMS-30	2	-	2	-	£323
DTPMS-40	1	2	-	1	£379
DTPMS-50	1	-	2	1	£465
DTPMS-60	1	-	-	1	£257
DTPMS-70	2	2	-	1	£405
DTPMS-80	2	-	2	1	£492



Available in Silver, White or Black finish.

DTPMSBKT Surface mounted fixing bracket kit (screw fixes to work surface) £36



DTPUNO-20

# ELECTRICAL ACCESSORIES

## DESKING

Desking

### Aircharge Induction Charging Modules - Qi Compatible.

Induction charging units for mobile phones - supplied with 3 metre lead to USB connector - supplied with UK 3 Pin Adaptor. Requires cut-out in furniture



**DTPCA**  
Module with Black Inner & Aluminium Bezel  
Cut Out P

£237



**DTPCB**  
Module with Black Inner & Black Bezel  
Cut Out P

£194



**TDP15**  
iPhone 5 Charging Case

£76



**TDP16**  
iPhone 6 Charging Case

£76



**TDP15**  
Wireless Charge Receiver supplied with Apple 30 pin, Lightning & Micro USB Connectors

£67



**TDPUP**  
USB / UK Main Plug

£26



**TDPUH4**  
4 x USB Hub. Can be used to power up to 4 Aircharge Modules from one supply

£118

### Outlet Types/Quantities

Code	UK POWER	CAT 5e DATA	CAT 6 DATA PULL THROUGH	1x USB-A SINGLE USB FAST CHARGE	Qi CHARGE	Cut out	Price
DTPEV-10	1	-	-	2	-	P	£257
DTPEV-20	1	-	-	1	1	P	£425
DTPEV-30	1	-	1	1	1	P	£518



Modules are available in either Black or White  
RDM CAT 6 Pull Through data connectors are supplied with 0.5 metre leads.



EVOLINE DTPEV-30

# ELECTRICAL ACCESSORIES

## DESKING

### Under Desk Modules

All under desk modules require a connector lead or a starter cable.

### Safe Electrical Wiring

For all types of power modules, please refer to the installation guidelines.

### Where Used

The icons shown indicate where modules can be used:



Desks



Tables



Seating

### Outlet Types/Quantities



Code

PM  
PM4  
PM6

2  
4  
6

Price

£44  
£67  
£77



Code

Description

Price

### Interconnecting Cables (GST18/3 Male to Female)

CL500  
CL1500  
CL3000  
CL5000

500mm  
1500mm  
3000mm  
5000mm

£23  
£26  
£31  
£39



### Starter Cables (GST18/3 Female to 13A Plug)

CLWP1  
CLWP2  
CLWP3  
CLWP5  
CLWP7

1000mm  
2000mm  
3000mm  
5000mm  
7000mm

£31  
£33  
£33  
£41  
£50



### ST to GST Adaptor (Converts ST Cables to GST)

CLA

-

£10



### Connector Blocks

CLA3  
CLA5

3-Way (1 Male /3 Female)  
5-Way (1 Male /5 Female)

£33  
£33



# MONITOR ARMS & ACCESSORIES

## DESKING

### Monitor Arms

A selection of single and twin arm monitor holders that will fit to the rear of worksurfaces and clamp into place or alternatively be attached through the worksurface. Please state required colour when ordering. Please check with our Sales Department for fitting Power Modules to Bench Deskits.

Clamp	Through Desk	Description	Price	
BAMA0	BFMA0	Manual height adjustable. 180° swivel with 508mm reach. Max load 10kg. Available in Silver, White or Black finish.	£211	
BAMA0-2	BFMA0-2	Twin arm manual height adjustable. 180° swivel with 508mm reach. Max load 10kg. Available in Silver, White or Black finish.	£350	
BAMA4	BFMA4	Dynamic gas height adjustable. 180° swivel with 570mm reach. Max load 9kg. Available in Silver or White finish.	£318	
BAMA6-2	N/A	Dynamic arm with 'technical chord' height adjustable lift fitted with Dual Mount Bar Maximum load 9Kg. 180° swivel with 670mm max. span between monitor centres. Available in Black, Silver or White finishes.	£550	
BAMA5	BFMA5	Gas assisted height adjustable. 180° swivel with 600mm reach. Max load 8kg *requires either Ø80 cable port or Ø12mm hole through worksurface, with clearance beneath. Available in Silver, White or Black finish.	£374	
BAMA5-2	BFMA5-2	Twin arm dynamic gas height adjustable. 180° swivel with 600mm reach. Max load 8kg. Available in Silver, White or Black finish.	£678	

# MONITOR ARMS & ACCESSORIES DESKING

## BAMA6 Clamp Options

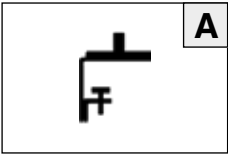

### Split Desk Clamp

For use where there is limited access to the edges of the desk surface. Can be completely disassembled to make installation easier. Fits desk thickness from 0mm to 65mm (2½").

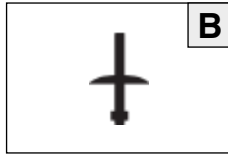

### Through Desk Clamp

For use in a Grommet hole or where drilling through the desk surface is possible. Fits desk thickness from 10mm (½") to 35mm (1 ⅓").

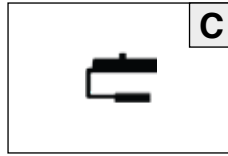







### Top Mount Clamp

For use on desks with sliding worktops or where it is not possible or desirable to drill through the desk surface. Range of standard clamps to fit desk thickness from 12mm (½") to 25mm (1").



# MONITOR ARMS & ACCESSORIES

## DESKING

Clamp	Through Desk	Description	Price	
BAMA7	BFMA7	Manual height adjustable. 180° swivel with 410mm reach. 400mm high pole with quick release. Max load 10kg. Cable management. Available in Silver, White or Black finish.	£158	
BAMA7-2	BFMA7-2	Twin arm manual height adjustable. 180° swivel with 410mm reach. 400mm high pole with quick release. Max load 10kg each. Cable management. Available in Silver, White or Black finish.	£242	
BAMA7-3	BFMA7-3	Triple arm manual height adjustable. 180° swivel with 410mm reach. 400mm high pole with quick release. Max load 10kg each. Cable management. Available in Silver, White or Black finish.	£428	
BAMA7-4	BFMA7-4	Quad arm manual height adjustable. 180° swivel with 410mm reach. 700mm high pole with quick release. Max load 10kg each. Cable management. Available in Silver, White or Black finish.	£507	
BAMA08	BFMA08	Quick release VESA mounting plate Quick release height adjustment Complete cable management Includes pre-assembled clamp and through desk fixing Available in black, silver and white from stock	£235	
BAMA08-2	BFMA08-2	Twin Arm, quick release VESA mounting plate 180° swivel with 385mm reach. Quick release height adjustment Complete cable management Includes pre-assembled clamp and through desk fixing Available in black, silver and white from stock	£386	



# MONITOR ARMS & ACCESSORIES DESKING

## CPU Holder - Adjustable

### Code

Bench <sup>2</sup>	Script	Mesa
BCPUH1	XCPU1	MECPUH1

### Description

Fits CPU 90mm wide x 290mm high to 240mm wide x 510mm high. Adjustable between stops using an Allen key. CPU clamps into place. Available in Silver finish.

### Price

£239



## Loop CPU Holder

### CPUL1

Simple, light and effective CPU holder. With minimalist black strap, integrates seamlessly with the desk. Fully adjustable, Easy to install with universal mounting rotating bracket, CPU is supported by webbing which is easily tightened by a ratchet mechanism. Fits CPU 80mm wide x 240mm high to 225mm wide x 500mm high.

### Price

£148



CPUL1 Loop Holder

# INTRODUCTION

## TABLES

Tables

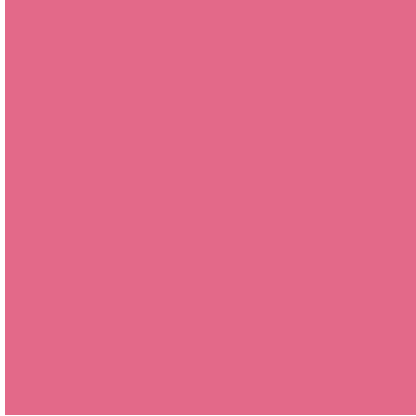



For optional cable management please refer to relevant product page or Cable Management in Desking section.



For optional desk service modules please see Electrical Accessories in Desking section.



For metal finishes please see Technical Information section.

Pastel Paint Surcharge = £33 per item.



For board finishes please see Technical Information section.

Adlington Oak Surcharge = 15% per item  
Light Concrete Surcharge = 15% per item

- A selective range of tables are available with 25mm and 36mm top panels (see opposite). Suffix code with relevant letter for required finish. Please refer to the technical information section for available colours. Only top panels are available in different finishes, all other components remain unaffected.

Group Z	Squared Edged 25mm MFC
Group B	Squared Edged 36mm MFC
Group C	Squared Edged 25mm Laminate Face
Group D	25mm MDF Laminate Face with Chamfered Edge
Group F	Square Edged 25mm MDF Dry Wipe Laminate Face
Group G	Squared Edged 36mm Laminate Face

### Edging Options

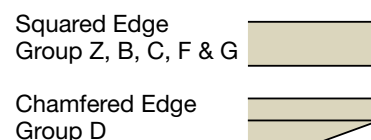

Laminate prices shown are for our Kiko range of laminates. Halo, Fenix and Filaflo laminates are available for a surcharge.

- Selected tables can be specified with 80 diameter circular cable ports or cut outs that can be used to access either cable trays or spines beneath the worksurface. They are positioned to avoid the underframes and can be fitted with a selection of service modules - specified separately.

Please refer to the relevant cable management section and Electrical Accessories section for further information.

Surcharge for Cable Ports: £37 retail

No surcharge for standard cut outs



### How to order Tables with/for power modules:

- Choose required power module.
- Make a note of the code & type of opening required (P, C1, C2 etc).
- Choose table range.
- Refer to cable management section to see available cut out type and positions for the range.

5) Make a note of the required table code with relevant cut out details (GTR2010ZC2 for example).

6) Place order with relevant table and module code.

Note: cut out positions not shown may not be available due to frame restraints.



C1, C2, C3 (cut out)



P (cable port) (surcharge £37)

- Unless otherwise stated tables are 727mm high when fitted with 25mm MFC top panels.

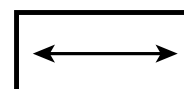

denotes grain direction

- LTF, LTC, LTA and LTD tables are available in a range of heights (see opposite).



Coffee - 455mm



Lounge - 575mm

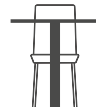

Dining - 745mm

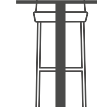

Mid poseur - 905mm

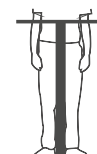

Poseur - 1125mm  
1105mm

## Betibo Blu

A member of the Betibo coffee table family, the Blu Table sits best at a room's centre. Whether in a lounge, casual meeting space or reception area, the low-level design sits at the ideal height for practicality. From drinks to documents, the two pieces in this range (800x800x330 and 1200x800x330) offer subtle support. Choose from leg options including Oak Stained, Black Stained and Dark Walnut. And tabletops with either a radius or square corner, and in our standard MFC or a laminate finish.

### Available Frame Colours

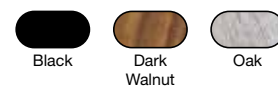

### Corner Options

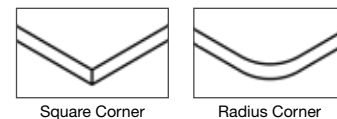

Code	Description	Corner Style	Dimensions	Height	Format	Price
BEC008RS	Betibo Blu CoffeeTable	Square	800 x 800	330	Square	£602
BEC008RR	Betibo Blu CoffeeTable	Radius	800 x 800	330	Square	£668
BEC012RS	Betibo Blu CoffeeTable	Square	1200 x 800	330	Rectangular	£655
BEC012RR	Betibo Blu CoffeeTable	Radius	1200 x 800	330	Rectangular	£722



10 Year  
Guarantee

NEW  
PRODUCT

# BETIBO TABLES

Tables



**BEC008RS**  
Betibo Blu  
SQUARE



**BEC008RR**  
Betibo Blu  
RADIUS

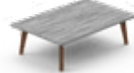

**BEC012RS**  
Betibo Blu  
SQUARE



**BEC012RR**  
Betibo Blu  
RADIUS



**BEX400CS**  
Betibo Baku  
N/A



**BEX500CS**  
Betibo Baku  
N/A



**BEX750CS**  
Betibo Baku  
N/A



**BEX400SS**  
Betibo Baku  
SQUARE



**BEX400SR**  
Betibo Baku  
RADIUS



**BEX500SS**  
Betibo Baku  
SQUARE



**BEX500SR**  
Betibo Baku  
RADIUS



**BEX750SS**  
Betibo Baku  
SQUARE



**BEX750SR**  
Betibo Baku  
RADIUS



**BED008RS**  
Betibo Barrier  
SQUARE



**BED008RR**  
Betibo Barrier  
RADIUS



**BED012RS**  
Betibo Barrier  
SQUARE



**BED012RR**  
Betibo Barrier  
RADIUS



**BED016RS**  
Betibo Barrier  
SQUARE



**BED016RR**  
Betibo Barrier  
RADIUS



**BED018RS**  
Betibo Barrier  
SQUARE



**BED018RR**  
Betibo Barrier  
RADIUS



**BEP008RS**  
Betibo Barrier  
SQUARE



**BEP008RR**  
Betibo Barrier  
RADIUS



**BEP018RS**  
Betibo Barrier  
SQUARE



**BEP018RR**  
Betibo Barrier  
RADIUS

## Betibo Baku

The Baku Table – part of the Betibo family of coffee tables - was designed with contemporary spaces in mind. Minimal in aesthetic, the highly versatile pieces suit any interior setting, bringing people together, whether in a work, social or family context. Use as a standalone solution or combine multiple sizes and heights to create a functional feature. Leg options include Oak Stained, Black Stained and Dark Walnut. And tabletops come with either a radius or square corner, and with our standard MFC or laminate finish.

### Available Frame Colours

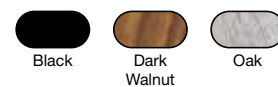

### Corner Options

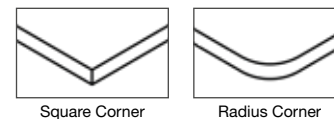

Code	Description	Corner Style	Dimensions	Height	Format	Price
BEX400CS	Betibo Baku X Leg Table	N/A	D590	400	Circular	£358
BEX500CS	Betibo Baku X Leg Table	N/A	D590	500	Circular	£377
BEX750CS	Betibo Baku X Leg Table	N/A	D590	750	Circular	£435
BEX400SS	Betibo Baku X Leg Table	Square	590 x 590	400	Square	£333
BEX400SR	Betibo Baku X Leg Table	Radius	590 x 590	400	Square	£399
BEX500SS	Betibo Baku X Leg Table	Square	590 x 590	500	Square	£352
BEX500SR	Betibo Baku X Leg Table	Radius	590 x 590	500	Square	£419
BEX750SS	Betibo Baku X Leg Table	Square	590 x 590	750	Square	£411
BEX750SR	Betibo Baku X Leg Table	Radius	590 x 590	750	Square	£478





## Betibo Barrier

Further bolstering the Betibo family of coffee table solutions, the Betibo Barrier Table in dining and poseur height options allows you total flexibility. In the workplace, the regular style makes the perfect meeting table. And in a hospitality venue, the taller format pairs with stool seating to offer a casual yet comfortable arrangement. The dining tables range from 800x800x730 to 1800x800x730, while the poseur tables start at 800x800x1040 and scale up to 1800x800x1040. All designs in the Betibo family include Oak Stained, Black Stained and Dark Walnut leg options. Tabletops come either with a radius or square corner, and our standard MFC or a laminate finish.

### Available Frame Colours

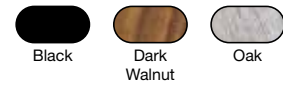

### Corner Options

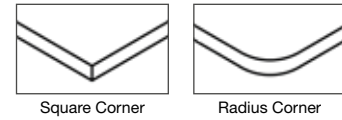

Tables

Code	Description	Corner Style	Dimensions	Height	Format	Price
BED008RS	Betibo Barrier Dining Table	Square	800 x 800	730	Square	£718
BED008RR	Betibo Barrier Dining Table	Radius	800 x 800	730	Square	£784
BED012RS	Betibo Barrier Dining Table	Square	1200 x 800	730	Rectangular	£772
BED012RR	Betibo Barrier Dining Table	Radius	1200 x 800	730	Rectangular	£840
BED016RS	Betibo Barrier Dining Table	Square	1600 x 800	730	Rectangular	£827
BED016RR	Betibo Barrier Dining Table	Radius	1600 x 800	730	Rectangular	£889
BED018RS	Betibo Barrier Dining Table	Square	1800 x 800	730	Rectangular	£858
BED018RR	Betibo Barrier Dining Table	Radius	1800 x 800	730	Rectangular	£924
BEP008RS	Betibo Barrier Poseur Table	Square	800 x 800	1040	Square	£1,074
BEP008RR	Betibo Barrier Poseur Table	Radius	800 x 800	1040	Square	£1,141
BEP018RS	Betibo Barrier Poseur Table	Square	1800 x 800	1040	Rectangular	£1,241
BEP018RR	Betibo Barrier Poseur Table	Radius	1800 x 800	1040	Rectangular	£1,308



# GD1 POSEUR TABLES

10 Year  
Guarantee

This striking family of tables brings both sophistication and functionality to breakout spaces, agile working areas or places where you simply want to connect for those 'away-from-desk' activities. Available in two height variations and a selection of footprints and finishes, GD1 is at home in any working landscape. The elegantly angled legs are produced in solid wood with an option for cleverly concealed cable control. Worksurfaces have softened corners and can feature integrated modules that bring all necessary services to each user.

## Leg Options



## Additional Information

Available in a variety of finishes including non-standard MFC and laminate. For alternative finishes or service modular options please contact our sales team.

Key	
'Powered'	Refers to tables with integral cable management within two legs, cable covers to the underside and fitted with 2No Back-Flip through desk modules, each with 2 UK power and single USB-A fast charge sockets.
'Cable Managed'	Refers to tables with integral cable management within two legs.
'Non-powered'	Refers to tables without cable management or service modules.

Code	Description	W	D	H	Group Z 25mm MFC	Group B 36mm MFC	Group C 25mm Lam Kiko	Group G 36mm Lam Kiko
<b>Rectangular Poseur Height</b>								
Leg colours available in Natural Ash and Black.								
GD1A2	Non-powered	2000	1000	1040	£2,974	£3,185	£3,341	£3,460
GD1A4	Powered	2000	1000	1040	£4,073	£4,283	£4,438	£4,535
GD1B2	Non-powered	2400	1200	1040	£3,000	£3,209	£3,366	£3,484
GD1B4	Powered	2400	1200	1040	£4,092	£4,302	£4,458	£4,557
GD1C2	Non-powered	2800	1200	1040	£3,553	£3,763	£3,920	£4,051
GD1C4	Powered	2800	1200	1040	£5,554	£5,765	£5,922	£6,054
GD1D2	Non-powered	1600	1600	1040	£2,662	£2,818	N/A	N/A
GD1D4	Cable Managed	1600	1600	1040	£3,181	£3,325	N/A	N/A
GD1E2	Non-powered	1200	1200	1040	£2,462	£2,545	£2,664	£2,730
GD1E4	Cable Managed	1200	1200	1040	£2,970	£3,051	£3,172	£3,235
GD1F2	Non-powered	1000	1000	1040	£2,439	£2,502	£2,572	£2,621
GD1F4	Cable Managed	1000	1000	1040	£2,946	£3,009	£3,081	£3,128

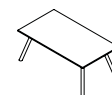

GD1 Poseur



This striking family of tables brings both sophistication and functionality to breakout spaces, agile working areas or places where you simply want to connect for those 'away-from-desk' activities. Available in two height variations and a selection of footprints and finishes, GD1 is at home in any working landscape. The elegantly angled legs are produced in solid wood with an option for cleverly concealed cable control. Worksurfaces have softened corners and can feature integrated modules that bring all necessary services to each user.

### Leg Options



### Additional Information

Available in a variety of finishes including non-standard MFC and laminate. For alternative finishes or service modular options please contact our sales team.

### Key

- 'Powered' Refers to tables with integral cable management within two legs, cable covers to the underside and fitted with 2No Back-Flip through desk modules, each with 2 UK power and single USB-A fast charge sockets.
- 'Cable Managed' Refers to tables with integral cable management within two legs.
- 'Non-powered' Refers to tables without cable management or service modules.

Code	Description	W	D	H	Group Z 25mm MFC	Group B 36mm MFC	Group C 25mm Lam Kiko	Group G 36mm Lam Kiko
<b>Rectangular Dining Height</b>								
Leg colours available in Natural Ash and Black.								
GD1A1	Non-powered	2000	1000	740	£2,831	£3,040	£3,197	£3,316
GD1A3	Powered	2000	1000	740	£3,943	£4,154	£4,307	£4,405
GD1B1	Non-powered	2400	1200	740	£2,907	£3,116	£3,274	£3,391
GD1B3	Powered	2400	1200	740	£3,962	£4,173	£4,329	£4,425
GD1C1	Non-powered	2800	1200	740	£3,392	£3,601	£3,757	£3,888
GD1C3	Powered	2800	1200	740	£5,377	£5,587	£5,743	£5,873
GD1D1	Non-powered	1600	1600	740	£2,499	£2,643	N/A	N/A
GD1D3	Cable Managed	1600	1600	740	£3,021	£3,165	N/A	N/A
GD1E1	Non-powered	1200	1200	740	£2,289	£2,369	£2,490	£2,555
GD1E3	Cable Managed	1200	1200	740	£2,810	£2,893	£3,010	£3,076
GD1F1	Non-powered	1000	1000	740	£2,265	£2,327	£2,397	£2,445
GD1F3	Cable Managed	1000	1000	740	£2,789	£2,850	£2,920	£2,968

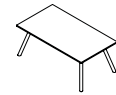

GD1 Dining

# GD10 DINING TABLES

10 Year Guarantee

Form beautifully meets function in the GD10 wooden dining table. The wide table top is supported by sturdy leg posts, and the piece is available in a range of dimensions to accommodate your needs comfortably, with plenty of room for all. The GD10's chic silhouette is well-suited for employee lounges, meeting rooms or collaborative workspaces and can be fitted with shelving, storage, cable management, service modules, lighting and power solutions.

Wood Colour



Oak Block

Oak Top



Lam/Lino Top



Additional Information

Bespoke sizes available on request. Cut out slots can be added on request. It is recommended that Pure Tung Oil be applied every 6 to 9 months. Contact our Sales Department for further information.

Tables

Code	Description	W	D	Option Cable Basket	Oak	25mm Lam Halo	25mm Lino Forbo
<b>751mm High</b>							
GD10A1	Four Leg	1600 x 900		MECT16	£3,312	£3,312	£3,644
GD10A2	Four Leg	1800 x 900		MECT18	£3,351	£3,351	£3,685
GD10A3	Four Leg	2000 x 900		MECT20	£3,389	£3,389	£3,727
GD10A4	Four Leg	2200 x 900		MECT20	£3,427	£3,427	£3,768
GD10A5	Four Leg	2400 x 900		MECT12 (x2)	£3,464	£3,464	£3,809
GD10B1	Four Leg	1600 x 1200		MECT16D	£4,270	£4,270	£4,696
GD10B2	Four Leg	1800 x 1200		MECT18D	£4,306	£4,306	£4,738
GD10B3	Four Leg	2000 x 1200		MECT20D	£4,344	£4,344	£4,781
GD10B4	Four Leg	2200 x 1200		MECT20D	£4,384	£4,384	£4,821
GD10B5	Four Leg	2400 x 1200		MECT12D (x2)	£4,422	£4,422	£4,863
GD10E1	Six Leg	3000 x 900		MECT14 (x2)	£5,680	£5,680	£6,247
GD10E2	Six Leg	4000 x 900		MECT20 (x2)	£6,431	£6,431	£7,073
GD10F1	Six Leg	3000 x 1200		MECT14D (x2)	£6,370	£6,370	£7,007
GD10F2	Six Leg	4000 x 1200		MECT20D (x2)	£8,419	£8,419	£9,260



Please note, prices are retail and include delivery. Installation is 5% of the nett value, with a minimum value of £450 nett. During normal working hours, Mondays to Fridays. Tables are supplied in packs for assembly on site. Access should be checked and confirmed. Top packs are supplied in one piece. To aid access, these can be supplied in shorter sections with split joints. **Surcharge per table: £599**



GD10 Table with Vapour Linoleum Top

The GD10 poseur table sits slightly higher than a typical wooden dining table, offering a modern alternative to conventional lounge or collaborative seating. The piece offers a generous table top and is available in a range of dimensions, suitable for your space and needs. The GD10 poseur table can be enhanced with a number of optional features to improve productivity, including lighting and power, storage, shelving, cable organisation and service module solutions.

Wood Colour



Oak Block

Oak Top



Lam/Lino Top

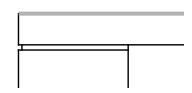

Additional Information

Bespoke sizes available on request. Cut out slots can be added on request. It is recommended that Pure Tung Oil be applied every 6 to 9 months. Contact our Sales Department for further information.

Code	Description	W	D	Option Cable Basket	Oak	25mm Lam Halo	25mm Lino Forbo
<b>1071mm High</b>							
GD10C1	Four Leg	1600 x 900		MECT16	£4,087	£4,087	£4,496
GD10C2	Four Leg	1800 x 900		MECT18	£4,123	£4,123	£4,537
GD10C3	Four Leg	2000 x 900		MECT20	£4,161	£4,161	£4,577
GD10C4	Four Leg	2200 x 900		MECT20	£4,198	£4,198	£4,620
GD10C5	Four Leg	2400 x 900		MECT12 (x2)	£4,237	£4,237	£4,659
GD10D1	Four Leg	1600 x 1200		MECT16D	£5,035	£5,035	£5,539
GD10D2	Four Leg	1800 x 1200		MECT18D	£5,072	£5,072	£5,580
GD10D3	Four Leg	2000 x 1200		MECT20D	£5,112	£5,112	£5,619
GD10D4	Four Leg	2200 x 1200		MECT20D	£5,147	£5,147	£5,662
GD10D5	Four Leg	2400 x 1200		MECT12D (x2)	£5,185	£5,185	£5,705
GD10G1	Six Leg	3000 x 900		MECT14 (x2)	£6,056	£6,056	£6,660
GD10G2	Six Leg	4000 x 900		MECT20 (x2)	£6,805	£6,805	£7,488
GD10H1	Six Leg	3000 x 1200		MECT14D (x2)	£6,671	£6,671	£7,336
GD10H2	Six Leg	4000 x 1200		MECT20D (x2)	£8,756	£8,756	£9,630



Please note, prices are retail and include delivery. Installation is 5% of the nett value, with a minimum value of £450 nett. During normal working hours, Mondays to Fridays. Tables are supplied in packs for assembly on site. Access should be checked and confirmed. Top packs are supplied in one piece. To aid access, these can be supplied in shorter sections with split joints. **Surcharge per table: £599**



GD10C5

# GD10 DINING LED TABLES



The GD10 with LED Light Bar offers a contemporary flourish to conventional lounge or collaborative seating. The piece offers a generous table top and is available in a range of dimensions, with an aluminium cased LED strip light fitted through the table top suitable for day and night-time use.

Wood Colour



Oak Block

Oak Top



Lam/Lino Top

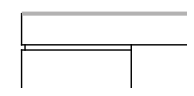

### Additional Information

Anodised aluminium light encased in solid engineered hardwood frame, with Polycarbonate diffuser & on/off switch. LED lit 100mm in from each leg - 4000K colour temp. Supplied with 3 metre cable.

Tables

Code	Description	W	D	Option Cable Basket	Oak	25mm Lam Halo	25mm Lino Forbo
<b>751mm High with 430mm High LED Light Bar</b>							
GD10A1L	Four Leg	1600 x 900		MECT16	£5,207	£5,207	£5,728
GD10A2L	Four Leg	1800 x 900		MECT18	£5,382	£5,382	£5,923
GD10A3L	Four Leg	2000 x 900		MECT20	£5,684	£5,684	£6,254
GD10A4L	Four Leg	2200 x 900		MECT20	£5,863	£5,863	£6,452
GD10A5L	Four Leg	2400 x 900		MECT12 (x2)	£6,005	£6,005	£6,605
GD10B1L	Four Leg	1600 x 1200		MECT16D	£6,164	£6,164	£6,782
GD10B2L	Four Leg	1800 x 1200		MECT18D	£6,340	£6,340	£6,974
GD10B3L	Four Leg	2000 x 1200		MECT20D	£6,642	£6,642	£7,304
GD10B4L	Four Leg	2200 x 1200		MECT20D	£6,820	£6,820	£7,504
GD10B5L	Four Leg	2400 x 1200		MECT12D (x2)	£6,962	£6,962	£7,658
GD10E1L	Six Leg	3000 x 900		MECT14 (x2)	£8,656	£8,656	£9,521
GD10E2L	Six Leg	4000 x 900		MECT20 (x2)	£10,778	£10,778	£11,856
GD10F1L	Six Leg	3000 x 1200		MECT14D (x2)	£9,093	£9,093	£10,004
GD10F2L	Six Leg	4000 x 1200		MECT20D (x2)	£12,766	£12,766	£14,043

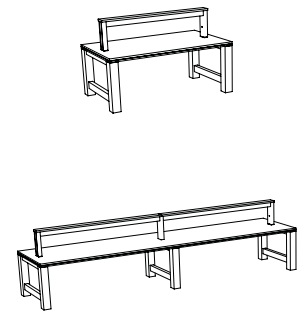

Please note, prices are retail and include delivery. Installation is 5% of the nett value, with a minimum value of £450 nett. During normal working hours, Mondays to Fridays. Tables are supplied in packs for assembly on site. Access should be checked and confirmed. Top packs are supplied in one piece. To aid access, these can be supplied in shorter sections with split joints. **Surcharge per table: £599**



# GD10 POSEUR LED TABLES

LEDs are extremely energy efficient and consume up to 90% less power than incandescent bulbs. Since LEDs use only a fraction of the energy of an incandescent light bulb there is a dramatic decrease in power costs, therefore, for creating an eco environment in a grand office space, the GD10 with LED would be perfect for reducing your impact on the environment.

Wood Colour



Oak Block

Oak Top

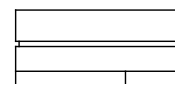

Lam/Lino Top



Additional Information

Anodised aluminium light encased in solid engineered hardwood frame, with Polycarbonate diffuser & on/off switch. LED lit 100mm in from each leg - 4000K colour temp. Supplied with 3 metre cable.

Code	Description	W	D	Option Cable Basket	Oak	25mm Lam Halo	25mm Lino Forbo
<b>1071mm High with 430mm High LED Light Bar</b>							
GD10C1L	Four Leg	1600 x 900		MECT16	£5,980	£5,980	£6,579
GD10C2L	Four Leg	1800 x 900		MECT18	£6,157	£6,157	£6,772
GD10C3L	Four Leg	2000 x 900		MECT20	£6,459	£6,459	£7,104
GD10C4L	Four Leg	2200 x 900		MECT20	£6,639	£6,639	£7,301
GD10C5L	Four Leg	2400 x 900		MECT12 (x2)	£6,776	£6,776	£7,456
GD10D1L	Four Leg	1600 x 1200		MECT16D	£6,929	£6,929	£7,624
GD10D2L	Four Leg	1800 x 1200		MECT18D	£7,104	£7,104	£7,814
GD10D3L	Four Leg	2000 x 1200		MECT20D	£7,407	£7,407	£8,149
GD10D4L	Four Leg	2200 x 1200		MECT20D	£7,585	£7,585	£8,343
GD10D5L	Four Leg	2400 x 1200		MECT12D (x2)	£7,725	£7,725	£8,499
GD10G1L	Six Leg	3000 x 900		MECT14 (x2)	£9,032	£9,032	£9,936
GD10G2L	Six Leg	4000 x 900		MECT20 (x2)	£11,154	£11,154	£12,268
GD10H1L	Six Leg	3000 x 1200		MECT14D (x2)	£9,394	£9,394	£10,333
GD10H2L	Six Leg	4000 x 1200		MECT20D (x2)	£13,104	£13,104	£14,415

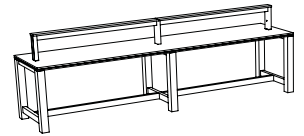
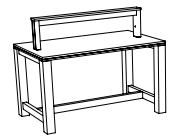

Please note, prices are retail and include delivery. Installation is 5% of the nett value, with a minimum value of £450 nett. During normal working hours, Mondays to Fridays. Tables are supplied in packs for assembly on site. Access should be checked and confirmed. Top packs are supplied in one piece. To aid access, these can be supplied in shorter sections with split joints. **Surcharge per table: £599**



GD10C5L





Tables

# GD10 BENCH SEATING TABLES



Complement the GD10 wooden dining table with chic and sturdy bench seating. Designed to match the silhouette of the table range, it will blend seamlessly into a modern workplace. Available in a range of lengths to accommodate your chosen table and a choice of original Oak block top or a coloured Halo Laminate top to answer to key interior trends.

Wood Colour



Oak Block

Oak Seat

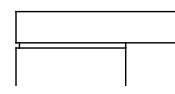

Lam Seat

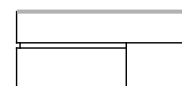

Additional Information

Bespoke sizes available on request. It is recommended that Pure Tung Oil be applied every 6 to 9 months. Contact our Sales Department for further information.

Tables

Code	Description	W	D	Oak	25mm Lam Halo
<b>450mm High Bench Seat</b>					
GD1005BS	Four Leg	500	x 350	£492	£492
GD1006BS	Four Leg	600	x 350	£528	£528
GD1008BS	Four Leg	800	x 350	£571	£571
GD1010BS	Four Leg	1000	x 350	£639	£639
GD1012BS	Four Leg	1200	x 350	£666	£666
GD1014BS	Six Leg	1400	x 350	£852	£852
GD1016BS	Six Leg	1600	x 350	£879	£879
GD1018BS	Six Leg	1800	x 350	£902	£902
GD1020BS	Six Leg	2000	x 350	£935	£935
GD1022BS	Six Leg	2200	x 350	£964	£964
GD1024BS	Six Leg	2400	x 350	£988	£988



GD10 Bench Seating





GD10 Dining

# GD10 CABLE MANAGEMENT TABLES

10 Year Guarantee



Tables

## Cable Baskets

Code	Basket Length	Type	Price
<b>Single Sided</b>			
MECT20	1832	20	£95
MECT18	1629	18	£93
MECT16	1426	16	£89
MECT14	1222	14	£87
MECT12	1019	12	£82
MECT10	816	10	£79



## Cable Baskets

Code	Basket Length	Type	Price
<b>Double Sided</b>			
MECT20D	1832	20D	£143
MECT18D	1629	18D	£138
MECT16D	1426	16D	£132
MECT14D	1222	14D	£131
MECT12D	1019	12D	£123
MECT10D	816	10D	£118

## Optional Worksurface Cut-Outs

When specifying cut-outs, suffix the table code with one of the below.  
Example of code - GD10A1C6

Code	Dimensions	Price	Diagram
P	Ø80mm Allows for UK 3 Pin plug and additional accessories	£73	
C4	Ø60mm Allows for UK 3 Pin plug	£73	
C5	400mm x 200mm Slot (Please specify position required)	£73	
C6	500mm x 60/20mm 'Dog-Bone' Slot (Please specify position required)	£73	



## Cable Spine

Code	Description	Price
GCR12B	1250mm - Black (42 Sections)	£118
GCR12W	1250mm - White (42 Sections)	£118





# GD10 CIRQUE TABLES

Capturing the trend for curved edges and circularity is our new GD10 Cirque table collection. Available in four sizes, and one functional height, the contemporary design highlights the beauty of natural wood with a stunning oak top. Additionally, several productivity features can be installed including lighting, power and cable organisation. Whether used to encourage collaboration work, support socialising or facilitate meetings, the GD10 Cirque has been built with the needs of modern spaces in mind.

Wood



GDQUE12  
Small Table - 1200Ø



GDQUE14  
Medium Table - 1400Ø



GDQUE16  
Large Table - 1600Ø



GDQUE18  
Extra Large Table - 1800Ø

Code	Description	Dimensions	Height	Leg Space	Price
GDQUE12	GD10 Cirque Table Small	1200Ø	751	550	£3,512
GDQUE14	GD10 Cirque Table Medium	1400Ø	751	550	£3,631
GDQUE16	GD10 Cirque Table Large	1600Ø	751	800	£4,585
GDQUE18	GD10 Cirque Table Extra Large	1800Ø	751	800	£4,737



Tables

# STEPS TABLES



The Steps table is part of an award winning family. It pairs seamlessly with the lounge and compact Steps chairs to create a distinct and effortless elegance.



Tables

Code	Description	W	D	H	Group Z 25mm MFC	Group C 25mm Lam Kiko	Group D 25mm CH Lam Kiko	
<b>Steel Frame</b>								
Steel Frames can accept wood cladding - surcharge: £505								
STT49C	Circular		Ø900	x 400	£613	£652	£704	○
STT59C	Circular		Ø900	x 575	£619	£657	£707	
STT49S	Square	900	x 900	x 400	£618	£654	£706	□
STT59S	Square	900	x 900	x 575	£620	£658	£710	
STT49E	Elliptical	1400	x 900	x 400	£784	£819	£873	◻
STT59E	Elliptical	1400	x 900	x 575	£787	£826	£876	



Steps Steel Frame

10 Year  
Guarantee

# STEPS TABLES

The Steps table is part of an award winning family. It pairs seamlessly with the lounge and compact Steps chairs to create a distinct and effortless elegance.



Code	Description	W	D	H	Group Z 25mm MFC	Group C 25mm Lam Kiko	Group D 25mm CH Lam Kiko	
<b>Aluminium Frame</b>								
STT49CA	Circular		Ø900	400	£613	£652	£704	○
STT59CA	Circular		Ø900	575	£619	£657	£707	
STT49SA	Square	900	900	400	£618	£654	£706	□
STT59SA	Square	900	900	575	£620	£658	£710	
STT49EA	Elliptical	1400	900	400	£784	£819	£873	⬭
STT59EA	Elliptical	1400	900	575	£787	£826	£876	

Tables



Steps Aluminium Frame

# LS21 TABLES

10 Year  
Guarantee

As part of our ever-growing portfolio of Lifestyle products, the LS21 family of tables has been introduced to co-ordinate with a selection of lounge, pyramid-based seating; making those 'away-from-desk' areas more cohesive.



Tables

Code	Top Shape	Dimensions	Group Z 25mm MFC	Group B 36mm MFC	Group C 25mm Lam Kiko	Group D 25mm CH Lam Kiko
<b>Coffee - 455mm High</b>						
LS21A1	Circular	Ø700	£336	£538	£700	£781
LS21A2	Circular	Ø800	£350	£555	£721	£797
LS21B1	Square	600 x 600	£310	£513	£667	£746
LS21B2	Square	700 x 700	£325	£528	£688	£765
<b>Lounge - 575mm High</b>						
LS21C1	Circular	Ø700	£343	£545	£706	£787
LS21C2	Circular	Ø800	£357	£560	£727	£805
LS21D1	Square	600 x 600	£318	£520	£674	£753
LS21D2	Square	700 x 700	£333	£533	£694	£771



As part of our ever-growing portfolio of Lifestyle products, the LS22 family of tables has been introduced to co-ordinate with a selection of lounge, 4 star-based seating ranges.



Code	Top Shape	Dimensions	Group Z 25mm MFC	Group B 36mm MFC	Group C 25mm Lam Kiko	Group D 25mm CH Lam Kiko
<b>Coffee - 455mm High</b>						
LS22A1	Circular	Ø700	£314	£516	£670	£751
LS22A2	Circular	Ø800	£328	£530	£691	£768
LS22B1	Square	600 x 600	£287	£490	£637	£719
LS22B2	Square	700 x 700	£302	£505	£658	£735
<b>Lounge - 575mm High</b>						
LS22C1	Circular	Ø700	£320	£525	£678	£758
LS22C2	Circular	Ø800	£336	£538	£698	£776
LS22D1	Square	600 x 600	£297	£496	£645	£724
LS22D2	Square	700 x 700	£310	£513	£666	£745

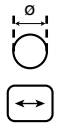
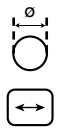

LS22

# LS23 TABLES



As part of our ever-growing portfolio of Lifestyle products, the LS23 family of tables has been introduced to co-ordinate with a selection of lounge, sled-framed seating ranges.



Tables

Code	Top Shape	Dimensions	Group Z 25mm MFC	Group B 36mm MFC	Group C 25mm Lam Kiko	Group D 25mm CH Lam Kiko	
<b>Coffee - 455mm High</b>							
LS23A1	Circular	Ø700	£287	£475	£610	£683	
LS23A2	Circular	Ø800	£301	£489	£628	£702	
LS23A3	Circular	Ø900	£316	£502	£646	£719	
LS23B1	Square	600 x 600	£260	£450	£586	£657	
LS23B2	Square	700 x 700	£276	£462	£604	£675	
LS23B3	Square	800 x 800	£289	£479	£621	£696	
LS23C1	Rectangular	1000 x 600	£294	£482	£627	£700	
LS23C2	Rectangular	1200 x 600	£308	£494	£645	£718	
LS23C3	Rectangular	1400 x 600	£321	£511	£666	£736	
<b>Lounge - 575mm High</b>							
LS23D1	Circular	Ø700	£294	£482	£618	£691	
LS23D2	Circular	Ø800	£308	£494	£636	£707	
LS23D3	Circular	Ø900	£321	£511	£653	£728	
LS23E1	Square	600 x 600	£270	£457	£591	£667	
LS23E2	Square	700 x 700	£282	£469	£610	£683	
LS23E3	Square	800 x 800	£297	£485	£628	£702	
LS23F1	Rectangular	1000 x 600	£301	£489	£635	£706	
LS23F2	Rectangular	1200 x 600	£316	£502	£652	£727	
LS23F3	Rectangular	1400 x 600	£329	£516	£671	£744	



LS23



10 Year  
Guarantee

# LS23 TABLES

Tables



# MOMENT WOODEN LEG TABLES

10 Year Guarantee

- Elegant Table system designed with legs positioned to enable users to sit at all sides.
- Available in a variety of sizes and footprints.

Wooden Leg Finishes



Tables

Code	Dimensions	Optional Cable Basket	Group Z 25mm MFC	Group B 36mm MFC	Group C 25mm Lam Kiko	Group D 25mm CH Lam Kiko
<b>Rectangular</b>						
MWTR2410	2400 x 1000	MECT18D	£1,257	£1,466	£1,624	£1,704
MWTR2210	2200 x 1000	MECT16D	£1,244	£1,454	£1,610	£1,692
MWTR2010	2000 x 1000	MECT14D	£1,233	£1,443	£1,598	£1,676
MWTR1810	1800 x 1000	MECT12D	£1,223	£1,433	£1,590	£1,666
MWTR1610	1600 x 1000	MECT10D	£1,212	£1,423	£1,579	£1,659
MWTR1410	1400 x 1000	MECT08D	£1,208	£1,416	£1,571	£1,655
MWTR2408	2400 x 800	MECT18D	£1,204	£1,413	£1,570	£1,651
MWTR2208	2200 x 800	MECT16D	£1,192	£1,401	£1,558	£1,636
MWTR2008	2000 x 800	MECT14D	£1,179	£1,390	£1,545	£1,625
MWTR1808	1800 x 800	MECT12D	£1,166	£1,376	£1,534	£1,612
MWTR1608	1600 x 800	MECT10D	£1,156	£1,364	£1,519	£1,600
MWTR1408	1400 x 800	MECT08D	£1,144	£1,356	£1,511	£1,594
MWTR1208	1200 x 800	MECT06D	£1,136	£1,346	£1,503	£1,584
<b>Square</b>						
MWTR1616	1600 x 1600	MECT10D	£1,300	£1,511	N/A	N/A
MWTR1414	1400 x 1400	MECT08D	£1,211	£1,422	N/A	N/A
MWTR1212	1200 x 1200	MECT06D	£1,121	£1,329	£1,486	£1,564
MWTR1010	1000 x 1000	MECT04D	£1,102	£1,311	£1,466	£1,550
<b>Circular</b>						
MWTC16	ø1600	MECT04D	£1,201	£1,409	N/A	N/A
MWTC14	ø1400	MECT04D	£1,152	£1,361	N/A	N/A
MWTC12	ø1200	MECT04D	£1,102	£1,311	£1,466	£1,550
MWTC10	ø1000	MECT04D	£1,077	£1,287	£1,444	£1,523
<b>Boat shaped</b>						
MWTB24	2400 x 1000/800	MECT18D	£1,352	£1,561	£1,719	£1,799
MWTB22	2200 x 1000/800	MECT16D	£1,339	£1,550	£1,704	£1,783
MWTB20	2000 x 1000/800	MECT14D	£1,325	£1,535	£1,691	£1,769
MWTB18	1800 x 1000/800	MECT12D	£1,314	£1,523	£1,677	£1,762
MWTB16	1600 x 1000/800	MECT10D	£1,301	£1,512	£1,666	£1,750
<b>Lozenge shaped</b>						
MWTL24	2400 x 1000/800	MECT14D	£1,352	£1,561	£1,719	£1,799
MWTL22	2200 x 1000/800	MECT16D	£1,339	£1,550	£1,704	£1,783
MWTL20	2000 x 1000/800	MECT12D	£1,325	£1,535	£1,691	£1,769

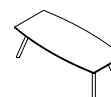
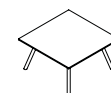
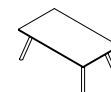

10 Year  
Guarantee

# MOMENT WOODEN LEG TABLES

Tables



Boat Shaped Wooden Leg Table

# MOMENT STEEL LEG TABLES

10 Year Guarantee

- Clean-lined aesthetics with ease of use in mind.
- Available in a variety of sizes and footprints.



Tables

Code	Dimensions	Optional Cable Basket	Group Z 25mm MFC	Group B 36mm MFC	Group C 25mm Lam Kiko	Group D 25mm CH Lam Kiko
<b>Rectangular</b>						
MSTR2410	2400 x 1000	MECT18D	£893	£1,091	£1,241	£1,321
MSTR2210	2200 x 1000	MECT16D	£881	£1,082	£1,229	£1,306
MSTR2010	2000 x 1000	MECT14D	£868	£1,071	£1,218	£1,295
MSTR1810	1800 x 1000	MECT12D	£859	£1,059	£1,210	£1,283
MSTR1610	1600 x 1000	MECT10D	£852	£1,051	£1,199	£1,276
MSTR1410	1400 x 1000	MECT08D	£845	£1,044	£1,193	£1,269
MSTR2408	2400 x 800	MECT18D	£843	£1,043	£1,192	£1,268
MSTR2208	2200 x 800	MECT16D	£831	£1,031	£1,181	£1,257
MSTR2008	2000 x 800	MECT14D	£819	£1,020	£1,166	£1,243
MSTR1808	1800 x 800	MECT12D	£805	£1,005	£1,155	£1,230
MSTR1608	1600 x 800	MECT10D	£796	£996	£1,144	£1,221
MSTR1408	1400 x 800	MECT08D	£786	£986	£1,135	£1,213
MSTR1208	1200 x 800	MECT06D	£780	£979	£1,128	£1,202
<b>Square</b>						
MSTR1616	1600 x 1600	MECT10D	£933	£1,135	N/A	N/A
MSTR1414	1400 x 1400	MECT08D	£851	£1,050	N/A	N/A
MSTR1212	1200 x 1200	MECT06D	£761	£961	£1,112	£1,186
MSTR1010	1000 x 1000	MECT04D	£747	£947	£1,091	£1,168
<b>Circular</b>						
MSTC16	ø1600	MECT04D	£837	£1,041	N/A	N/A
MSTC14	ø1400	MECT04D	£794	£993	N/A	N/A
MSTC12	ø1200	MECT04D	£747	£947	£1,091	£1,168
MSTC10	ø1000	MECT04D	£723	£923	£1,072	£1,147
<b>Boat shaped</b>						
MSTB24	2400 x 1000/800	MECT18D	£983	£1,184	£1,331	£1,409
MSTB22	2200 x 1000/800	MECT16D	£971	£1,168	£1,321	£1,394
MSTB20	2000 x 1000/800	MECT14D	£956	£1,156	£1,305	£1,383
MSTB18	1800 x 1000/800	MECT12D	£948	£1,147	£1,296	£1,373
MSTB16	1600 x 1000/800	MECT10D	£935	£1,137	£1,283	£1,362
<b>Lozenge shaped</b>						
MSTL24	2400 x 1000/800	MECT16D	£983	£1,184	£1,331	£1,409
MSTL22	2200 x 1000/800	MECT14D	£971	£1,168	£1,321	£1,394
MSTL20	2000 x 1000/800	MECT12D	£956	£1,156	£1,305	£1,383

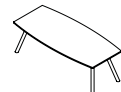
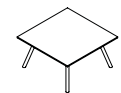
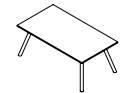

10 Year  
Guarantee

# MOMENT STEEL LEG TABLES

Tables



Rectangular and Circular Steel Leg Tables

# MOMENT LARGE FORMAT TABLES



## Large Format Tables - Starter & Add-on Units

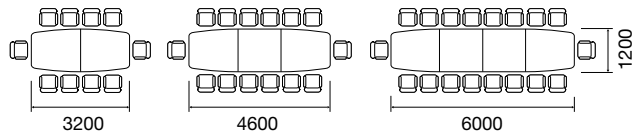

## Setup Example

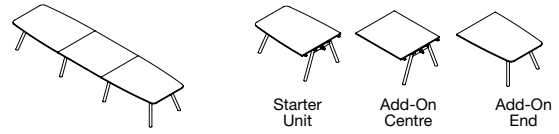

Tables



Code	Dimensions	Optional Cable Basket	Group Z 25mm MFC	Group B 36mm MFC	Group C 25mm Lam Kiko	Group D 25mm CH Lam Kiko	
<b>Starter Unit</b>							
MWBET16	1600 x 1200/800 Wood Leg	MECT12D	£1,098	£1,307	£1,463	£1,543	↔
MSBET16	1600 x 1200/800 Steel Leg	MECT12D	£741	£939	£1,088	£1,165	
<b>Add-On End</b>							
MWBET16A	1600 x 1200/800 Wood Leg	MECT12D	£739	£951	£1,105	£1,186	↔
MSBET16A	1600 x 1200/800 Steel Leg	MECT12D	£553	£753	£900	£977	
<b>Add-On Centre</b>							
MWCT14A	1400 x 1200 Wood Leg	MECT14D	£739	£951	£1,105	£1,186	↔
MSCT14A	1400 x 1200 Steel Leg	MECT14D	£553	£753	£900	£977	

C4 Planter Box  
C5 Access Flap



£90 Surcharge  
£301 Surcharge

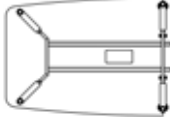

## Optional Cut Out Specification

<p><b>Rectangular, Boat Shaped and Lozenge</b> 1000w not available with C1 Cut Out C4 Cut Outs are only available on Rectangular tables 1400w and over. C5 Cut Outs are only available on Rectangular tables 1600w and over</p> 	<p><b>Boardroom Starter Boardroom End</b></p> 
<p><b>Circular</b> C2 and C3 Cut Outs only available on 1400ø and 1600ø C1, C4 and C5 Cut Outs are not available on Circular tables.</p> <p><b>Square</b> 1000w and 800w not available with C1 Cut Out. C4 and C5 Cut Outs are only available on 1600w Square tables. C2 and C3 Cut Outs not available on 800w tables.</p> 	<p><b>Boardroom Centre</b></p> 

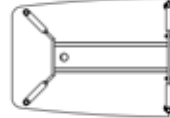
## Optional Cable Port Specification

<p><b>Rectangular, Boat Shaped and Lozenge</b></p> 	<p><b>Boardroom Starter Boardroom End</b></p> 
<p><b>Circular and Square</b></p> 	<p><b>Boardroom Centre</b></p> 

### Cable Baskets

MECT20D	2000	1832	336	£138
MECT18D	1800	1629	336	£134
MECT16D	1600	1426	336	£127
MECT14D	1400	1222	336	£126
MECT12D	1200	1019	336	£119
MECT10D	1000	816	336	£114
MECT08D	800	612	336	£112
MECT06D	600	410	336	£110
MECT04D	400	210	336	£108

### Cable Spine

ø60 x 700h

Code	Colour	Price
BCRB	Black	£86
BCRS	Silver	£86
BCRW	White	£86



# DECK INTRODUCTION TABLES



Introducing Deck, a timeless bench table and seating collection that boasts effortless sophistication and stylish simplicity. With its crisp, clean lines and distinctive finishes, the Deck collections' versatility can perfectly fulfil modern workplace requirements.

The Deck collection is an ideal choice for office and leisure environments - whether used for hot-desking, corporate meetings or communal dining. Its flexibility facilitates individual work and collaborative discussions, while making it even easier for employees and executives alike to move seamlessly from one activity or project to another. The Deck collection saves time and space when both are limited - it is the obvious choice for any working environment.

This refined collection can be extensively customised to fulfil the needs of your space and it is available in a range of specifications. These include options for sitting or standing height models, various end frame materials and customisable unit dimensions. The Deck collection makes use of your entire landscape and can be offered in an almost limitless combination of surface finishes. In fact, each bench or table unit can be created to your preferences or made to satisfy unique corporate requirements.

Whether you'd like a classic wood effect, vibrant block colours or funky patterns this family of furniture will help you to make a statement and enhance every inch of your space.



Single Laminate  
Single colour with matching or contrasting edge - SUFFIX 'S'



Dual Laminate  
Two colour with matching or contrasting edge - SUFFIX 'D'

## MFC Finishes -

- Available in single colour MFC Finishes - Both styles of panel ended products are produced flat-packed and assembled on site.
- Steel Framed products are supplied fully assembled.
- MFC Deck products have 38mm Tops & 25mm End Panels, where appropriate.
- Available with Contrasting Edge



## Laminate Finishes -

- Panel Ended and Inset Panel products are produced flat-packed and assembled on site.
- Mitred Panel Ended and Steel Framed products are supplied fully assembled and we would recommend specialised handling to site. For delivery and installation details, contact our Sales Team. Laminate Deck products have 38mm Tops & End Panels, where appropriate.
- Available with Contrasting Edging.

Alternative laminates are available (Halo, Fenix, Filafo) Please refer to the Technical Data Section. Surcharges will be applicable.

## All Deck Products

- Use stools from our Seating section with Poseur Height Tables.
- Small Bench Seats can nest under wider Dining Tables.
- All Deck products may require a team lift due to their heavy nature.
- Inset Panel Deck have their ends inset by 300mm.



Deck Mitred Poseur Height with Dual Laminate



## Single Laminate

Panel ended and inset tables and benches of various sizes with 38mm top and panel ends with a single colour laminate finish with matching or contrasting edge. 40mm square steel four legged tables and benches of various sizes with 38mm top panels in a single laminate finish with matching or contrasting edge. Frames available in Silver, White, Black, Grey or Chrome paint.

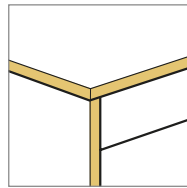

Panel Ended

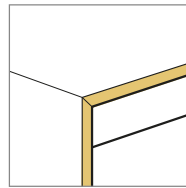

Panel Ended (Mitred)

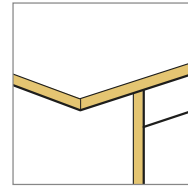

Inset Panel Ended

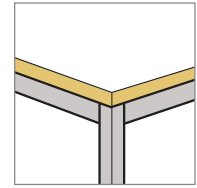

Square Steel

## Dual Laminate

Panel ended and inset tables and benches of various sizes with 38mm top and panel ends in a choice of two laminate colour finishes on outside and inside faces. Matching or contrasting edge.

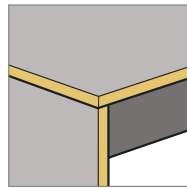

Panel Ended

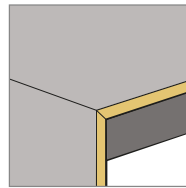

Panel Ended (Mitred)

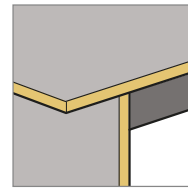

Inset Panel Ended

## MFC

Panel ended and inset tables and benches of various sizes with 38mm top panels and 25mm panel ends in a choice of melamine finishes with matching or contrasting edge. 40mm square steel four legged tables and benches of various sizes with 38mm top panels in a choice of melamine finishes with matching or contrasting edge. Frames available in Silver, White, Black, Grey or Chrome paint.

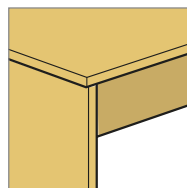

Panel Ended

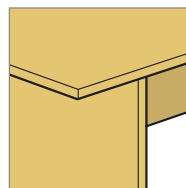

Inset Panel Ended

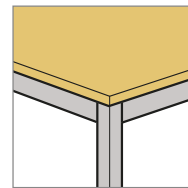

Square Steel



Deck Mitred Edge with Single Laminate

# DECK MITRED TABLES



Deck Mitred is the premium product within this collection. It incorporates traditional joinery skills and hand-applied finishes. Choose from an array of laminate finishes that can be uniform or specified as two-toned, single colours or patterned relief. These variations enable the model to complement its surroundings, stirring emotions and adding a sense of theatre.

**Deck Laminate Surcharges**  
 Halo Collection £208  
 Fenix Collection £719  
 Filafo Collection £3,742



Tables

Code	Dimensions	Single Laminate Price Kiko	Dual Laminate Price Kiko
<b>Mitred Panel Ended</b>			
<b>Poseur 1100mm high</b>			
DCPTRL208	2000 x 800	£2,561	£2,973
DCPTRL188	1800 x 800	£2,319	£2,730
DCPTRL168	1600 x 800	£2,160	£2,572
<b>Dining 750mm high</b>			
DCTRL22	2200 x 800	£2,378	£2,727
DCTRL20	2000 x 800	£2,268	£2,678
DCTRL18	1800 x 800	£2,144	£2,557
DCTRL16	1600 x 800	£1,966	£2,330
DCTRL14	1400 x 800	£1,830	£2,239
<b>Bench Seats 450mm high</b>			
DCBRL22	2200 x 350	£1,278	£1,509
DCBRL20	2000 x 350	£1,272	£1,256
DCBRL18	1800 x 350	£1,097	£1,325
DCBRL16	1600 x 350	£1,005	£1,234
DCBRL14	1400 x 350	£939	£1,168
DCBRL12	1200 x 350	£895	£1,123

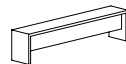
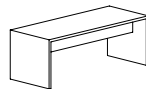
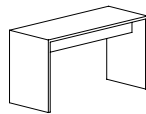

Deck Mitred Poseur Height Table with Single Laminate

# DECK INSET PANEL END TABLES

We certainly believe in style and finesse, but functionality and form are also essential. Each Deck Inset model shares the same design DNA as the rest of the collection, but acknowledges the fact that there are times when users need to sit at the ends of the benches as well as at the sides. The inset panels included in these models allow for this by providing sitting or standing space at both ends of the work surface, while matching their flush panel ended counterparts in finish and style.

**Deck Laminate Surcharges**  
 Halo Collection £208  
 Fenix Collection £719  
 Filalo Collection £3,742



Code	Dimensions	Single Laminate Price Kiko	Dual Laminate Price Kiko	
<b>Inset Panel Ended</b>				
<b>Poseur 1100mm high</b>				
DCPTL208	2000 x 800	£2,173	£2,522	
DCPTL188	1800 x 800	£1,966	£2,316	
DCPTL168	1600 x 800	£1,835	£2,184	
<b>Dining 750mm high</b>				
DCTEL22	2200 x 800	£2,018	£2,312	
DCTEL20	2000 x 800	£1,926	£2,274	
DCTEL18	1800 x 800	£1,816	£2,169	
DCTEL16	1600 x 800	£1,667	£1,977	
DCTEL14	1400 x 800	£1,552	£1,900	
<b>Bench Seats 450mm high</b>				
DCBEL22	2200 x 350	£1,086	£1,278	
DCBEL20	2000 x 350	£1,077	£1,195	
DCBEL18	1800 x 350	£931	£1,123	
DCBEL16	1600 x 350	£854	£1,045	
DCBEL14	1400 x 350	£797	£993	
DCBEL12	1200 x 350	£760	£954	

Code	Dimensions	MFC	
<b>Inset Panel</b>			
<b>Poseur 1100mm high</b>			
DCPTM208	2000 x 800	£1,225	
DCPTM188	1800 x 800	£1,104	
DCPTM168	1600 x 800	£1,028	
<b>Dining 750mm high</b>			
DCTEM22	2200 x 800	£1,135	
DCTEM20	2000 x 800	£1,083	
DCTEM18	1800 x 800	£1,022	
DCTEM16	1600 x 800	£940	
DCTEM14	1400 x 800	£876	
<b>Bench Seats 450mm high</b>			
DCBEM22	2200 x 350	£716	
DCBEM20	2000 x 350	£665	
DCBEM18	1800 x 350	£609	
DCBEM16	1600 x 350	£557	
DCBEM14	1400 x 350	£507	
DCBEM12	1200 x 350	£495	



Deck Inset Panel End Poseur Height Table with Single Laminate

# DECK PANEL END TABLES



Panel Ended Deck differs only slightly from Deck Mitred, with the top surface being a separate piece, this allows you to specify contrasting finishes to create a two-toned look. Available in Dining height and Poseur height with matching bench seating to forge a sleek and modern dining space or a clean and simple away-from-desk area or touch down zone.

**Deck Laminate Surcharges**  
 Halo Collection £208  
 Fenix Collection £719  
 Filaflo Collection £3,742



Tables

Code	Dimensions	Single Laminate Price Kiko	Dual Laminate Price Kiko
<b>Panel Ended</b>			
<b>Poseur 1100mm high</b>			
DCPTL208	2000 x 800	£2,285	£2,654
DCPTL188	1800 x 800	£2,069	£2,435
DCPTL168	1600 x 800	£1,929	£2,297

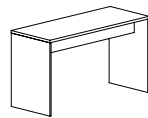

Code	Dimensions	Single Laminate Price Kiko	Dual Laminate Price Kiko
<b>Dining 750mm high</b>			
DCTL22	2200 x 800	£2,122	£2,433
DCTL20	2000 x 800	£2,026	£2,391
DCTL18	1800 x 800	£1,913	£2,281
DCTL16	1600 x 800	£1,754	£2,083
DCTL14	1400 x 800	£1,630	£2,001

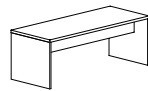

Code	Dimensions	Single Laminate Price Kiko	Dual Laminate Price Kiko
<b>Bench Seats 450mm high</b>			
DCBL22	2200 x 350	£1,140	£1,345
DCBL20	2000 x 350	£1,134	£1,256
DCBL18	1800 x 350	£978	£1,182
DCBL16	1600 x 350	£896	£1,101
DCBL14	1400 x 350	£836	£1,043
DCBL12	1200 x 350	£797	£1,002

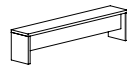

Code	Dimensions	MFC Price
<b>Panel Ended</b>		
<b>Poseur 1100mm high</b>		
DCPTM208	2000 x 800	£1,285
DCPTM188	1800 x 800	£1,163
DCPTM168	1600 x 800	£1,085

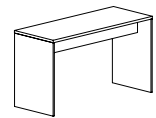

Code	Dimensions	MFC Price
<b>Dining 750mm high</b>		
DCTM22	2200 x 800	£1,195
DCTM20	2000 x 800	£1,136
DCTM18	1800 x 800	£1,074
DCTM16	1600 x 800	£988
DCTM14	1400 x 800	£923

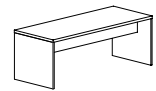

Code	Dimensions	MFC Price
<b>Bench Seats 450mm high</b>		
DCBM22	2200 x 350	£754
DCBM20	2000 x 350	£699
DCBM18	1800 x 350	£643
DCBM16	1600 x 350	£587
DCBM14	1400 x 350	£534
DCBM12	1200 x 350	£520

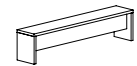

Deck Poseur Height MFC

5 Year Guarantee

# DECK STEEL TABLES

The Deck Steel model combines the features of the panel ended and inset models, by allowing users to sit all along and around the work surface, without the structure impinging on their leg space. Its lightweight yet robust frame is fully welded and offers an additional opportunity for users to introduce metallic colours into the working landscape, while remaining cohesive with adjacent furniture from different ranges. Deck Steel frames boast minimalistic style and clear air circulation within open-plan areas. Each model is available with sitting and standing height work surfaces, with matching bench seating.

**Deck Laminate Surcharges**  
 Halo Collection £178  
 Fenix Collection £579  
 Filafo Collection £3,033



Tables

Code            Dimensions            Single Laminate Price Kiko

**Steel Frame 40mm x 40mm square**

**Poseur Tables 1100mm high**

DCPTSL188	1800 x 800	£1,201
DCPTSL168	1600 x 800	£1,077
DCPTSL148	1400 x 800	£977
DCPTSL186	1800 x 600	£1,179
DCPTSL166	1600 x 600	£1,058

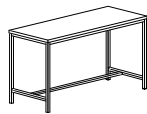

**Dining Tables 750mm high**

DCTSL18	1800 x 800	£1,154
DCTSL16	1600 x 800	£1,037
DCTSL14	1400 x 800	£932
DCTSL12	1200 x 800	£857
DCTSL10	1000 x 800	£825



**Bench Seats 450mm high**

DCBSL18	1800 x 350	£792
DCBSL16	1600 x 350	£722
DCBSL14	1400 x 350	£636
DCBSL12	1200 x 350	£562
DCBSL10	1000 x 350	£534



Code            Dimensions            MFC Price

**Steel Frame 40mm x 40mm square**

**Poseur 1100mm high**

DCPTSM188	1800 x 800	£892
DCPTSM168	1600 x 800	£797
DCPTSM148	1400 x 800	£725
DCPTSM186	1800 x 600	£868
DCPTSM166	1600 x 600	£781

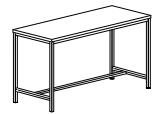

**Dining 750mm high**

DCTSM18	1800 x 800	£840
DCTSM16	1600 x 800	£756
DCTSM14	1400 x 800	£677
DCTSM12	1200 x 800	£622
DCTSM10	1000 x 800	£598

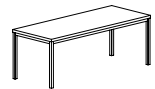

**Bench Seats 450mm high**

DCBSM18	1800 x 350	£575
DCBSM16	1600 x 350	£525
DCBSM14	1400 x 350	£463
DCBSM12	1200 x 350	£411
DCBSM10	1000 x 350	£390



Deck Steel Dining Height Table

# DECK SEAT PADS TABLES



Enhance your relaxation by adding an upholstered seat pad to your Deck Bench Seats. With two options available, choose between a cost-effective cushioning or a maximum comfort cushioning for extended use.



Tables

Code	Dimensions	Band 1	Band 2	Band 3	Band 4	Band 5	Band 6	Band 7
Optional Upholstered Seat Pads - fit to any Deck Seats with bolt fixing kit supplied. (* Requires User Modification)								
DC22SP	2200wx 350d x 50h	£289	£347	£425	£497	£579	£653	£725
DC20SP	2000wx 350d x 50h	£278	£333	£403	£470	£545	£612	£678
DC18SP	1800wx 350d x 50h	£269	£318	£380	£442	£511	£573	£632
DC16SP	1600wx 350d x 50h	£257	£301	£358	£413	£474	£530	£585
DC14SP	1400wx 350d x 50h	£246	£286	£338	£387	£441	£490	£538
DC12SP	1200wx 350d x 50h	£236	£271	£316	£358	£405	£447	£492
DC10SP	1000wx 350d x 50h	£213	£235	£260	£285	£312	£336	£361



Code	Dimensions	Band 1	Band 2	Band 3	Band 4	Band 5	Band 6	Band 7
Optional Maximum Comfort Upholstered Seat Pads - fit to any Deck Seats with bolt fixing kit supplied. (* Requires User Modification)								
DC22SM	2200wx 350d x 65h	£303	£366	£446	£525	£609	£686	£762
DC20SM	2000wx 350d x 65h	£292	£348	£424	£494	£574	£643	£712
DC18SM	1800wx 350d x 65h	£282	£333	£401	£465	£534	£600	£664
DC16SM	1600wx 350d x 65h	£271	£318	£378	£435	£498	£557	£613
DC14SM	1400wx 350d x 65h	£258	£300	£355	£405	£463	£513	£562
DC12SM	1200wx 350d x 65h	£249	£284	£332	£377	£426	£470	£514
DC10SM	1000wx 350d x 65h	£227	£243	£273	£299	£326	£352	£378



Maximum Comfort Upholstered Seat Pad

5 Year  
Guarantee

## DECK SEAT PADS TABLES

Tables



Deck Panel Ended Poseur Height with Single Laminate

iMedia units are tables designed for collaborative work, presentations and informal meetings. They can be used to mount display monitors, house I.T. equipment and promote connectivity.



- Available in three footprint styles, three lengths & two heights.
- Supplied with equipment cabinets to the front and rear.
- Can support up to 42" monitors (not supplied).
- Fitted with 36mm MFC Tops.
- Available with a selection of optional fitted fascia modules, see below.

Tables

### How To Specify

1. Select Base Code
2. Add suffix letter of service module if required
3. Order complete table

Example of code: IMA2210HC  
(Angular Shaped Table with Type C module)

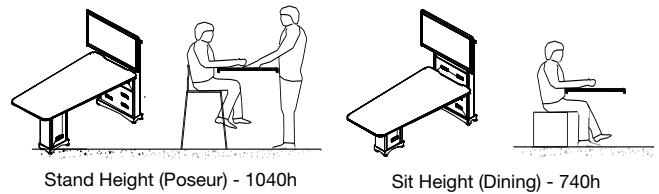

Module	Outlet Types/Quantities					
	UK POWER	CAT 6 DATA	2x USB-A FAST CHARGE	VGA & AUDIO	HDMI	SINGLE USB DATA
Type A	3	-	-	-	-	-
Type B	2	-	1	-	-	-
Type C	1	-	1	-	1	1
Type D	2	1	-	-	-	-
Type E	2	-	-	1	-	-
Type F	1	-	-	1	1	1

### Optional Fascia Modules

All modules containing electrical outlets are supplied with a short lead to a male Wieland GST plug. These modules are available in Black, Silver or White and require a starter cable – sold separately. Data modules, including RJ45, HDMI & data USB are hardwired to a 3 metre lead fitted with an appropriate connector. Suffix code with relevant letter.

Stand Height Base Code	Sit Height Base Code	Dimensions	MFC Price	Type A Module Price	Type B Module Price	Type C Module Price	Type D Module Price	Type E Module Price	Type F Module Price	
<b>Angular Shaped</b>										
IMA2210H	IMA2210L	2200w x 1000/800d	£3,576	£3,725	£3,821	£3,951	£3,767	£3,892	£4,022	↔
IMA2010H	IMA2010L	2000w x 1000/800d	£3,561	£3,712	£3,809	£3,939	£3,751	£3,879	£4,010	
IMA1810H	IMA1810L	1800w x 1000/800d	£3,522	£3,671	£3,771	£3,899	£3,712	£3,838	£3,971	
<b>Lozenge Shaped</b>										
IML2210H	IML2210L	2200w x 1000/800d	£3,576	£3,725	£3,821	£3,951	£3,767	£3,892	£4,022	↔
IML2010H	IML2010L	2000w x 1000/800d	£3,561	£3,712	£3,809	£3,939	£3,751	£3,879	£4,010	
IML1810H	IML1810L	1800w x 1000/800d	£3,522	£3,671	£3,771	£3,899	£3,712	£3,838	£3,971	
<b>Rectangular</b>										
IMR2210H	IMR2210L	2200w x 1000d	£3,576	£3,725	£3,821	£3,951	£3,767	£3,892	£4,022	↔
IMR2010H	IMR2010L	2000w x 1000d	£3,561	£3,712	£3,809	£3,939	£3,751	£3,879	£4,010	
IMR1810H	IMR1810L	1800w x 1000d	£3,522	£3,671	£3,771	£3,899	£3,712	£3,838	£3,971	

### Power Bar

Additional-Gang Socket Set - supplied with 3 metre lead to UK Plug fits within rear column.

Code	Price
IM6PM	£157







Stand Height Lozenge Shaped iMedia Table

# BENCH<sup>2</sup> TABLES

10 Year  
Guarantee

- Designed to work in the same environment as their desking counterpart.
- Available in a variety of sizes and footprints.
- Delivered and installed fully assembled.
- For accessories and cable management refer to Bench<sup>2</sup> Cable Trays & Accessories.



Leg styles

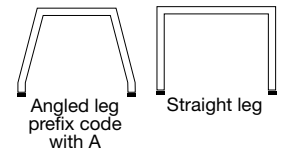

Angled leg not available on double sided add-on units.

Tables

Starter Unit Code	Dimensions	Optional Cable Tray Code	Group Z 25mm MFC	Group B 36mm MFC	Group C 25mm Lam Kiko
<b>Rectangular</b>					
BFT2010	2000 x 1000	BFCT20S-I	£678	£893	£1,052
BFT1810	1800 x 1000	BFCT18S-I	£671	£887	£1,045
BFT1610	1600 x 1000	BFCT16S-I	£665	£876	£1,038
BFT2008	2000 x 800	BFCT20S-I	£670	£884	£1,044
BFT1808	1800 x 800	BFCT18S-I	£648	£862	£1,023
BFT1608	1600 x 800	BFCT16S-I	£641	£856	£1,014
BFT1408	1400 x 800	BFCT14S-I	£634	£845	£1,007
BFT1208	1200 x 800	BFCT12S-I	£553	£764	£924
<b>Square</b>					
BFT1616	1600 x 1600	BFCT16D-I	£1,027	£1,241	N/A
BFT1414	1400 x 1400	BFCT14D-I	£1,014	£1,226	N/A
BFT1212	1200 x 1200	BFCT12D-I	£760	£972	£1,133
BFT1010	1000 x 1000	BFCT10S-I	£576	£789	£951
<b>Circular</b>					
BFTC16	ø1600	BFCT10S-I	£678	£893	N/A
BFTC14	ø1400	BFCT10S-I	£652	£864	N/A
BFTC12	ø1200	BFCT08S-I	£618	£831	£991
BFTC10	ø1000	BFCT06S-I	£570	£784	£940
BFTC08	ø800	BFCT06S-I	£543	£758	£920



Rectangular Starter Unit Straight Leg with Cable Ports (-P)

Add-on Unit Code	Dimensions	Optional Cable Tray Code	Group Z 25mm MFC	Group B 36mm MFC	Group C 25mm Lam
<b>Rectangular</b>					
Intermediate end frame not available					
BFT2010A	2000 x 1000	BFCT20S-I	£585	£797	£959
BFT1810A	1800 x 1000	BFCT18S-I	£578	£792	£954
BFT1610A	1600 x 1000	BFCT16S-I	£563	£781	£938
BFT2008A	2000 x 800	BFCT20S-I	£563	£781	£938
BFT1808A	1800 x 800	BFCT18S-I	£545	£760	£921
BFT1608A	1600 x 800	BFCT16S-I	£540	£753	£911
BFT1408A	1400 x 800	BFCT14S-I	£530	£742	£902
BFT1208A	1200 x 800	BFCT12S-I	£463	£674	£834



**Square Meeting Table**

Intermediate End frames supplied (except 1000 x 1000)

BFT1616A	1600 x 1600	BFCT16D-I	£956	£1,168	N/A
BFT1414A	1400 x 1400	BFCT14D-I	£939	£1,152	N/A
BFT1212A	1200 x 1200	BFCT12D-I	£674	£888	£1,047
BFT1010A	1000 x 1000	BFCT10S-I	£468	£680	£841



**Optional Cable Ports / Cut Outs**

Standard cable port quantity and cutout quantity/positions are shown opposite.

When specifying - suffix the table code with the relevant letter.

Example of code - BFT1616ZC1 (25mm MFC top panel with 430mm x 132mm cut out)

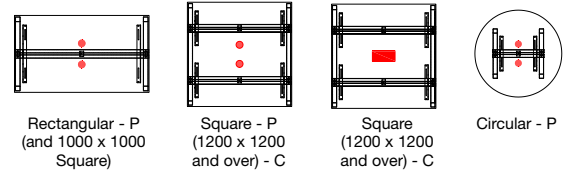

Code	Description	W	D	H	MFC Price
------	-------------	---	---	---	-----------

**Reception Tables**

**Fully Welded 32mm Square Four Legged**  
25mm MFC top panels.

BRT106Z	Rectangular	1000 x	600 x	400	£468
BRT088Z	Square	800 x	800 x	400	£440
BRT066Z	Square	600 x	600 x	400	£371
BRTC08Z	Circular	Ø800	x	400	£468
BRTC06Z	Circular	Ø600	x	400	£447



Rectangular Starter Unit Angled Leg with Add-on Unit with Optional Service Modules

# D3K TABLES

10 Year  
Guarantee

- Fully welded robust construction free standing tables.
- Designed to work in the same environment as their desking counterpart.
- Available in a variety of sizes and footprints.
- For accessories and cable management refer to Cable Management in Desking section.



Tables

Code	Dimensions	Optional Cable Basket	Group Z 25mm MFC	Group B 36mm MFC	Group C 25mm Lam Kiko	Group D 25mm CH Lam Kiko		
<b>Rectangular</b>								
GTR2410	2400 x 1000	MECT14	£694	£906	£1,068	£1,150		
GTR2210	2200 x 1000	MECT10	£641	£856	£1,014	£1,098		
GTR2010	2000 x 1000	MECT10	£602	£816	£976	£1,058		
GTR1810	1800 x 1000	MECT06	£554	£765	£925	£1,008		
GTR1610	1600 x 1000	MECT06	£526	£735	£897	£979		
GTR1410	1400 x 1000	MECT06	£500	£718	£875	£957		
GTR24	2400 x 800	MECT14	£638	£854	£1,012	£1,097		
GTR22	2200 x 800	MECT10	£589	£799	£960	£1,043		
GTR20	2000 x 800	MECT10	£547	£761	£922	£1,005		
GTR18	1800 x 800	MECT06	£497	£710	£872	£955		
GTR16	1600 x 800	MECT06	£469	£684	£842	£925		
GTR14	1400 x 800	MECT06	£447	£660	£821	£902		
GTR12	1200 x 800	-	£424	£636	£796	£878		
<b>Circular</b>								
GTC16	ø1600	-	£678	£893	N/A	N/A		
GTC14	ø1400	-	£652	£864	N/A	N/A		
GTC12	ø1200	-	£618	£831	£991	£1,072		
GTC10	ø1000	-	£560	£771	£933	£1,017		
GTC08	ø800	-	£534	£751	£909	£993		
<b>Square</b>								
GTR1616	1600 x 1600	-	£646	£861	N/A	N/A		
GTR1414	1400 x 1400	-	£620	£832	N/A	N/A		
GTR1212	1200 x 1200	-	£585	£797	£959	£1,042		
GTR1010	1000 x 1000	-	£529	£741	£901	£984		
<b>Boat Shaped</b>								
GTB24	2400 x 1000 x 800	MECT14	£878	£1,092	£1,252	£1,336		
GTB22	2200 x 1000 x 800	MECT10	£829	£1,042	£1,202	£1,283		
GTB20	2000 x 1000 x 800	MECT10	£785	£995	£1,156	£1,239		
GTB18	1800 x 1000 x 800	MECT06	£730	£946	£1,105	£1,187		
GTB16	1600 x 1000 x 800	MECT06	£707	£923	£1,084	£1,166		
GTB14	1400 x 1000 x 800	MECT06	£689	£900	£1,060	£1,143		
GTB12	1200 x 1000 x 800	-	£665	£876	£1,038	£1,118		
<b>Lozenge Shaped</b>								
GTL24	2400 x 1000 x 800	MECT14	£922	£1,134	£1,294	£1,374		
GTL22	2200 x 1000 x 800	MECT10	£872	£1,085	£1,244	£1,327		
GTL20	2000 x 1000 x 800	MECT10	£826	£1,038	£1,198	£1,279		
<b>Oval Shaped</b>								
GTE16	1600 x 1100	-	£707	£923	£1,084	£1,166		
<b>Boardroom End Table</b>								
GBET16	1600 x 1400	MECT10	£817	£1,027	N/A	N/A		
GBET1612	1600 x 1200	MECT10	£760	£972	£1,133	£1,213		
<b>Boardroom Centre Table</b>								
GBCT14	1400 x 1400	MECT10	£577	£790	N/A	N/A		
GBCT1412	1400 x 1200	MECT10	£538	£752	£910	£994		

MFC Laminate

**Sample footprints:**

Seating capacities for guidance only and can differ depending on size of chair used.

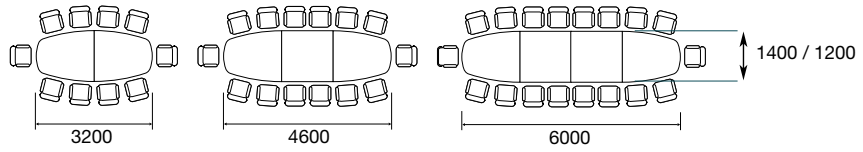

**Optional Cable Ports / Cut Outs**

Standard cable port quantity and cutout quantity/positions are shown opposite.

Example of code - GTR2010BC2.  
(36mm MFC top panel with 272mm x 132mm cut out)

When specifying - suffix the table code with the relevant letter.

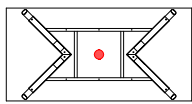

Rectangular P

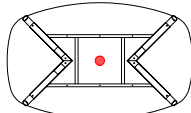

Lozenge P

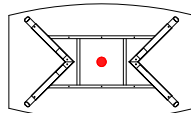

Boat P

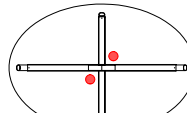

Oval P

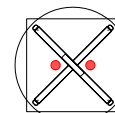

Square / Circular P

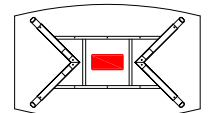

Boat C  
GTB12 will not accept C1 cutout

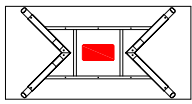

Rectangular C  
GTR12 will not accept C1 cutout

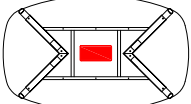

Lozenge C

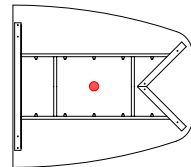

Large Format End P

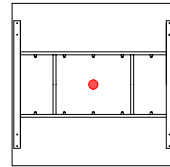

Large Format Centre P

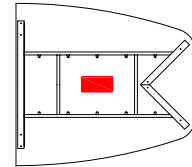

Large Format End C

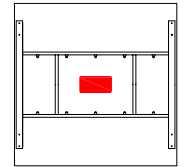

Large Format Centre C



Boardroom End Tables shown with Optional Service Modules

# EX10 & X10 TABLES

10 Year  
Guarantee

- Stylish and functional.
- Available in Panel Ended or Metal Frame.
- Available in a variety of sizes and footprints
- All EX10 tables have 25mm thick MFC panel ends.

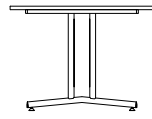

X10 Cantilever Frame  
Rectangular, Boat,  
Lozenge, Large Format

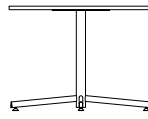

X10 Cross Frame  
Circular, Square

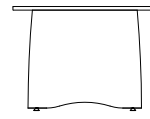

EX10 Panel End Frame  
Rectangular, Boat,  
Lozenge, Large Format

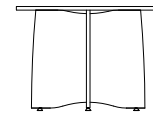

EX10 Panel Cross Frame  
Circular, Square, Oval



Tables

EX10 Panel End	X10 Metal Frame	Dimensions	Optional Cable Basket Code	Group Z 25mm MFC	Group B 36mm MFC	Group C 25mm Lam Kiko	Group D 25mm CH Lam Kiko
<b>Rectangular</b>							
KNPTR2410	KNTR2410	2400 x 1000	MECT18	£680	£895	£1,053	£1,136
KNPTR2210	KNTR2210	2200 x 1000	MECT16	£633	£844	£1,006	£1,087
KNPTR2010	KNTR2010	2000 x 1000	MECT14	£578	£792	£954	£1,037
KNPTR1810	KNTR1810	1800 x 1000	MECT12	£533	£750	£908	£991
KNPTR1610	KNTR1610	1600 x 1000	MECT10	£508	£722	£879	£962
KNPTR1410	KNTR1410	1400 x 1000	MECT08	£488	£700	£861	£942
KNPTR24	KNTR24	2400 x 800	MECT18	£628	£838	£1,000	£1,084
KNPTR22	KNTR22	2200 x 800	MECT16	£577	£790	£952	£1,034
KNPTR20	KNTR20	2000 x 800	MECT14	£527	£738	£899	£980
KNPTR18	KNTR18	1800 x 800	MECT12	£482	£694	£856	£937
KNPTR16	KNTR16	1600 x 800	MECT10	£454	£667	£828	£909
KNPTR14	KNTR14	1400 x 800	MECT08	£434	£645	£805	£891
KNPTR12	KNTR12	1200 x 800	MECT06	£410	£622	£785	£865



Under frame is positioned to accept chairs at the end of the table

## Circular

KNPTC16	-	ø1600	-	£671	£887	N/A	N/A
KNPTC14	-	ø1400	-	£641	£856	N/A	N/A
KNPTC12	KNTC12	ø1200	-	£554	£765	£925	£1,053
KNPTC10	KNTC10	ø1000	-	£504	£719	£876	£959
KNPTC08	KNTC08	ø800	-	£468	£680	£841	£924



## Square

KNPTR1616	-	1600 x 1600	-	£514	£727	N/A	N/A
KNPTR1414	-	1400 x 1400	-	£473	£688	N/A	N/A
KNPTR1212	KNTR1212	1200 x 1200	-	£414	£630	£789	£872
KNPTR1010	KNTR1010	1000 x 1000	-	£390	£604	£765	£846



## Boat Shaped

KNPTB24	KNTB24	2400 x 1000 x 800	MECT18	£868	£1,082	£1,241	£1,325
KNPTB22	KNTB22	2200 x 1000 x 800	MECT16	£818	£1,028	£1,192	£1,274
KNPTB20	KNTB20	2000 x 1000 x 800	MECT14	£766	£979	£1,138	£1,223
KNPTB18	KNTB18	1800 x 1000 x 800	MECT12	£722	£933	£1,093	£1,176
KNPTB16	KNTB16	1600 x 1000 x 800	MECT10	£694	£906	£1,068	£1,150
KNPTB14	KNTB14	1400 x 1000 x 800	MECT08	£669	£880	£1,043	£1,128
KNPTB12	KNTB12	1200 x 1000 x 800	MECT06	£644	£859	£1,018	£1,101



Under frame is positioned to accept chairs at the end of the table

## Lozenge Shaped

KNPTL24	KNTL24	2400 x 1000 x 800	MECT18	£909	£1,122	£1,282	£1,364
KNPTL22	KNTL22	2200 x 1000 x 800	MECT16	£864	£1,074	£1,237	£1,320
KNPTL20	KNTL20	2000 x 1000 x 800	MECT14	£817	£1,027	£1,188	£1,273



Under frame is positioned to accept chairs at the end of the table

## Oval Shaped

KNPTE16	-	1600 x 1100	-	£722	£933	£1,093	£1,176
---------	---	-------------	---	------	------	--------	--------

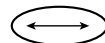

10 Year  
Guarantee

## EX10 & X10 TABLES

Tables

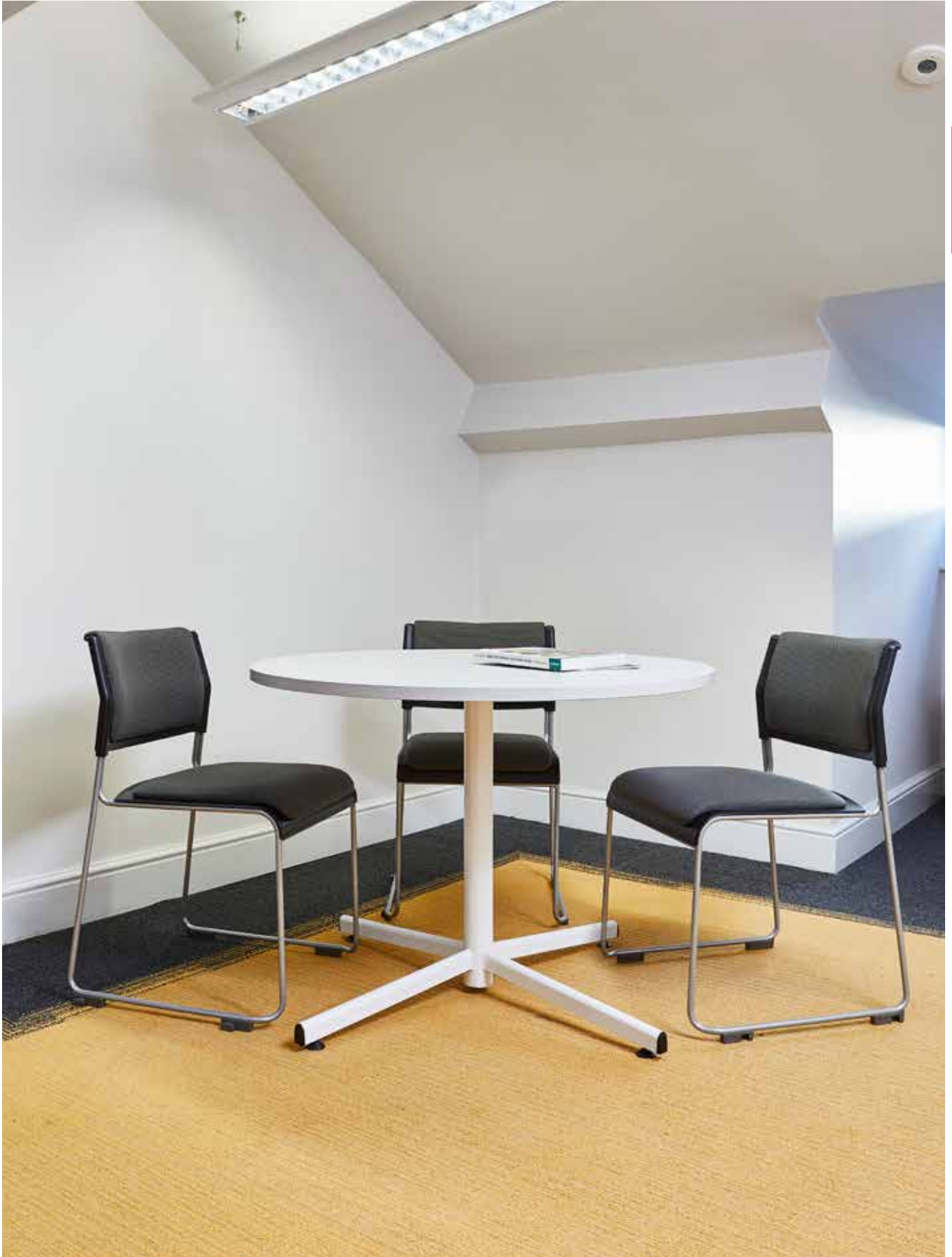

X10 Cross Frame Circular Shaped Table

# EX10 LARGE FORMAT TABLES

10 Year Guarantee

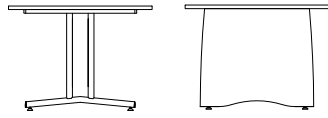

**X10 Cantilever Frame**  
Rectangular, Boat, Lozenge, Large Format

**EX10 Panel End Frame**  
Rectangular, Boat, Lozenge, Large Format



Tables

## Large Format Tables - Starter & Add-on Units

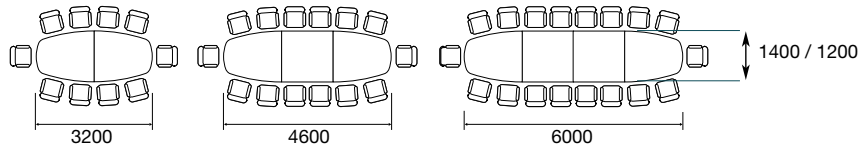

### Sample footprints:

Seating capacities for guidance only and can differ depending on size of chair used.

EX10 Panel End	X10 Metal Frame	Dimensions	Optional Cable Basket Code	Group Z 25mm MFC	Group B 36mm MFC	Group C 25mm Lam Kiko	Group D 25mm CH Lam Kiko	MFC	Laminate
<b>Starter Unit</b>									
KNPBET16	KNBET16	1600 x 1400	MECT12	£872	£1,085	N/A	N/A		
KNPBET1612	KNBET1612	1600 x 1200	MECT12	£817	£1,028	£1,188	£1,272		
<b>Add-on End Unit</b>									
KNPBET16A	KNBET16A	1600 x 1400	MECT12	£665	£876	N/A	N/A		
KNPBET1612A	KNBET1612A	1600 x 1200	MECT12	£608	£825	£980	£1,066		
<b>Add-on Centre Unit</b>									
KNPBCT14A	KNBCT14A	1400 x 1400	MECT14	£665	£876	N/A	N/A		
KNPBCT1412A	KNBCT1412A	1400 x 1200	MECT14	£608	£825	£980	£1,066		



EX10 Panel End Large Format Starter & Add-on End Unit



## Optional Cable Ports / Cut Outs

Standard cable port quantity and cutout quantity/positions are shown opposite.

\*Denotes inset leg by 300mm

When specifying - suffix the table code with the relevant letter.

Example of code - KNPTB24ZP  
(EX10 Panel Ended boat shaped 25mm MFC top with cable ports)

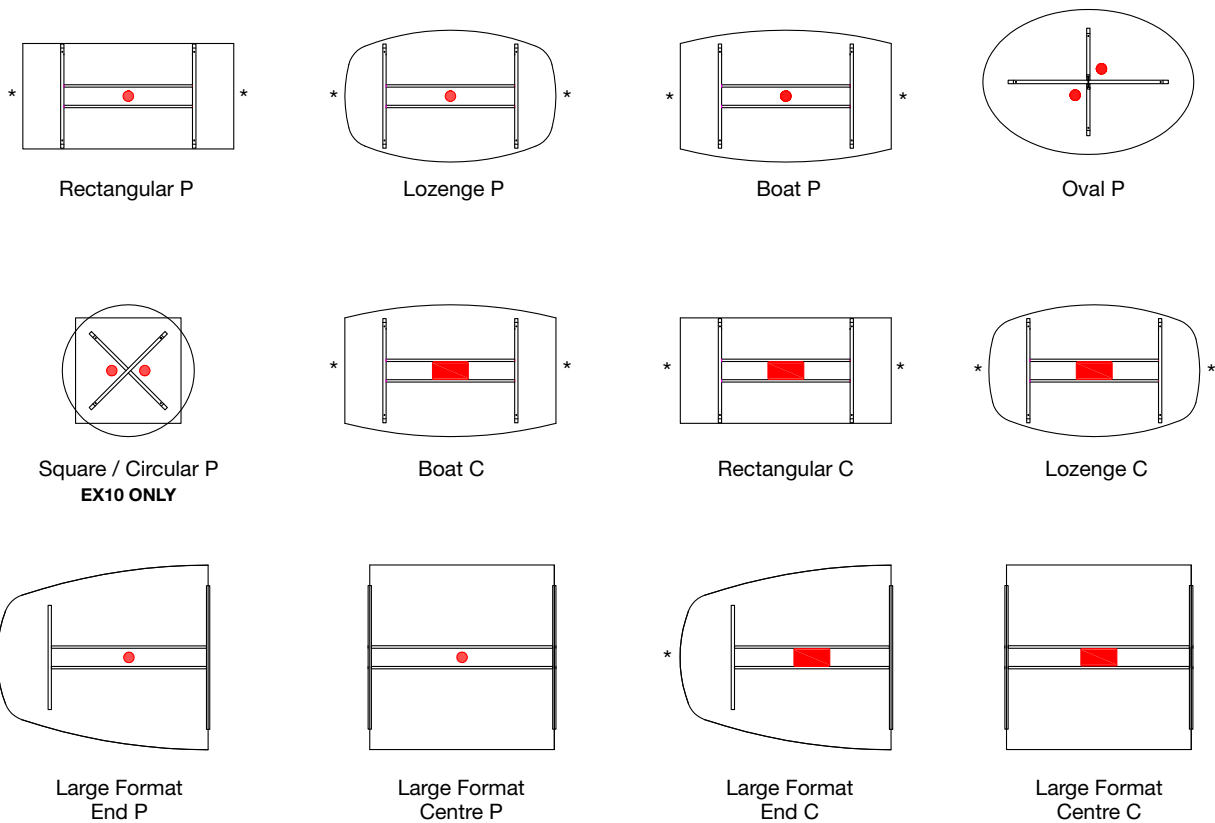

## Cable Management

See Cable Management for cable baskets & cable spines.

## Outer Leg Cover

Code	Where Used	Price
KNSECR	X10 Metal Frame	£42

## Inner Riser Kit

Can only be used with outer leg covers.

Code	Where Used	Price
KNERI	X10 Metal Frame Inclusive of inner cover, cable restraints and plastic channels	£39



# SCRIPT TABLES



This simple but stylish table range features interconnecting underframes that provide strength whilst keeping the users knee space clear.

- Available with angled or straight legged options.
- Available in a large selection of footprints.
- K.D. product that is delivered then installed fully assembled.
- 25mm MFC top panels.



Leg styles

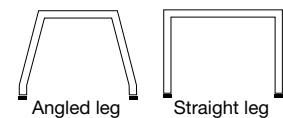

Tables

Angled Leg		Straight Leg		Dimensions	MFC Price	Angled Leg		Straight Leg		Dimensions	MFC Price
<b>Dining Rectangular</b>								<b>Dining Circular</b>			
XTA188	XTS188			1800 x 800	£447	XTAC16	XTSC16			ø1600	£577
XTA168	XTS168			1600 x 800	£428	XTAC14	XTSC14			ø1400	£520
XTA148	XTS148			1400 x 800	£411	XTAC12	XTSC12			ø1200	£465
XTA128	XTS128			1200 x 800	£389	XTAC10	XTSC10			ø1000	£411
XTA187	XTS187			1800 x 700	£440	XTAC08	XTSC08			ø800	£355
XTA167	XTS167			1600 x 700	£419						
XTA147	XTS147			1400 x 700	£402						
XTA127	XTS127			1200 x 700	£381						
<b>Dining Square</b>						<b>Dining Lozenge Shaped</b>					
XTAS12	XTSS12			1200 x 1200	£428	XTAL188	XTSL188			1800 x 800	£486
XTAS10	XTSS10			1000 x 1000	£336	XTAL168	XTSL168			1600 x 800	£465
XTAS08	XTSS08			800 x 800	£298	XTAL148	XTSL148			1400 x 800	£447
XTAS07	XTSS07			700 x 700	£289	XTAL128	XTSL128			1200 x 800	£428
XTAS06	XTSS06			600 x 600	£278						
						<b>Dining Rounded Corner Square</b>					
						XTAP12	XTSP12			1200 x 1200	£465
						XTAP10	XTSP10			1000 x 1000	£374
						XTAP08	XTSP08			800 x 800	£336
						XTAP07	XTSP07			700 x 700	£326
						XTAP06	XTSP06			600 x 600	£319
<b>Coffee - 455mm High</b>				<b>Top shape</b>		<b>Lounge - 575mm High</b>				<b>Top shape</b>	
XRTAC08	XRTSC08	Circular		Ø800	£298	XTAC12L	XTSC12L	Circular		Ø1200	£465
XRTAC06	XRTSC06	Circular		Ø600	£261	XTAC10L	XTSC10L	Circular		Ø1000	£411
XRTAS06	XRTSS06	Square		600 x 600	£227	XTAC08L	XTSC08L	Circular		Ø800	£355
XRTA106	XRTS106	Rectangular		1000 x 600	£298	XTAS08L		Square		800 x 800	£298
XRTAL106	XRTSL106	Lozenge		1000 x 600	£319	XTAS07L		Square		700 x 700	£289
XRTAP06	XRTSP06	RC Square		600 x 600	£240	XTAS06L		Square		600 x 600	£278



Angled Leg Coffee Rectangular Table

This stylish three-sided table range is a good alternative to traditional circular and square offerings. Catering for small or medium user groups.



- Available with fully welded tubular steel frame or boxed panel supports.
- Available as a mobile option.
- Can be fitted with a central cable port for services.
- 25mm MFC top panels.

Metal Frame Code	Panel Support Code	A	B	C	MFC Price
------------------	--------------------	---	---	---	-----------

### Static

TNF18	TNP18	1800 x	1800 x	1800	£560
TNF16	TNP16	1600 x	1600 x	1600	£543
TNF14	TNP14	1400 x	1400 x	1400	£512



Metal Framed

### Static with Central Cable Port

TNF18P	TNP18P	1800 x	1800 x	1800	£602
TNF16P	TNP16P	1600 x	1600 x	1600	£568
TNF14P	TNP14P	1400 x	1400 x	1400	£540



### Mobile with Central Cable Port

TNF18MP	-	1800 x	1800 x	1800	£697
TNF16MP	-	1600 x	1600 x	1600	£667
TNF14MP	-	1400 x	1400 x	1400	£644



Panel Support

# DOC TABLES



These circular tables with a crescent scoop can be used individually or docked against each other to form fluid configurations.



- Supplied on fully welded steel frames with circular legs with options for Mobile or Static units.
- Work surface 'cut-outs' interlock with curved edges.
- 25mm MFC top panels.

Tables

Code	A	B	MFC Price
------	---	---	-----------

### Static Crescent Shaped

TPACS14	ø1400 x ø1400		£512
TPACS08	ø800 x ø800		£411



### Mobile Crescent Shaped

TPACM14	ø1400 x ø1400		£561
TPACM08	ø800 x ø800		£463



### Static Tablet Shaped

TTICS16	1600 x ø800 x ø800		£554
TTICS14	1400 x ø800 x ø800		£512



### Mobile Tablet Shaped

TTICM16	1600 x ø800 x ø800		£603
TTICM14	1400 x ø800 x ø800		£561

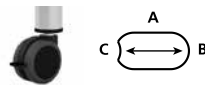

Crescent Shaped

# SWING OUT TABLES

Frames are designed to swing together to reduce the overall footprint and save space when not needed.

- Supplied on fully welded steel frames with circular legs with options for Mobile or Static units.
- Resulting nest can be left in situ or moved flush against a wall.
- 25mm MFC top panels.

Surcharge for Pastel Paint – £33 per item



Code	A	B	MFC Price
------	---	---	-----------

**Static Table**

TST22S	ø1900 x	ø2200	£1,165
--------	---------	-------	--------

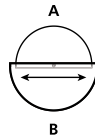

**Mobile Table**

TST22M	ø1900 x	ø2200	£1,165
--------	---------	-------	--------

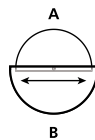

Tables



Swing Out

# STAND HEIGHT TABLES

10 Year Guarantee

- Designed for use in touch-down areas for informal meetings.
- Continuous fully-welded steel frame with 50mm diameter circular legs.
- Available in a selection of footprints and two heights.
- 25mm MFC top panels.



Tables

Code      A      B      C      MFC Price

### Rectangular Tables 1100mm High 800mm Deep

TS818RHZ	1800 x	800		£531
TS816RHZ	1600 x	800		£457
TS814RHZ	1400 x	800		£424
TS812RHZ	1200 x	800		£405
TS810RHZ	1000 x	800		£399



### Rectangular Tables 1100mm High 600mm Deep

TS618RHZ	1800 x	600		£486
TS616RHZ	1600 x	600		£418
TS614RHZ	1400 x	600		£390
TS612RHZ	1200 x	600		£379
TS610RHZ	1000 x	600		£369



### Peninsular Tables 1100mm High 800mm Deep

TS818PHZ	1800 x	800	x Ø1000	£584
TS816PHZ	1600 x	800	x Ø1000	£518
TS814PHZ	1400 x	800	x Ø1000	£494
TS812PHZ	1200 x	800	x Ø1000	£477

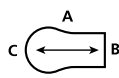

### Peninsular Tables 1100mm High 600mm Deep

TS618PHZ	1800 x	600	x Ø800	£532
TS616PHZ	1600 x	600	x Ø800	£474
TS614PHZ	1400 x	600	x Ø800	£448
TS612PHZ	1200 x	600	x Ø800	£429

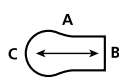

### Circular Tables 1100mm High

TSC10HZ	Ø1000			£463
TSC08HZ	Ø800			£442



Code      A      B      C      MFC Price

### Rectangular Tables 900mm High 800mm Deep

TS818RH9	1800 x	800		£513
TS816RH9	1600 x	800		£442
TS814RH9	1400 x	800		£411
TS812RH9	1200 x	800		£393
TS810RH9	1000 x	800		£386



### Rectangular Tables 900mm High 600mm Deep

TS618RH9	1800 x	600		£466
TS616RH9	1600 x	600		£401
TS614RH9	1400 x	600		£377
TS612RH9	1200 x	600		£361
TS610RH9	1000 x	600		£347



### Peninsular Tables 900mm High 800mm Deep

TS818PH9	1800 x	800	x Ø1000	£562
TS816PH9	1600 x	800	x Ø1000	£500
TS814PH9	1400 x	800	x Ø1000	£474
TS812PH9	1200 x	800	x Ø1000	£455

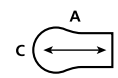

### Peninsular Tables 900mm High 600mm Deep

TS618PH9	1800 x	600	x Ø800	£512
TS616PH9	1600 x	600	x Ø800	£454
TS614PH9	1400 x	600	x Ø800	£432
TS612PH9	1200 x	600	x Ø800	£414

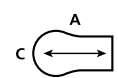

### Circular Tables 900mm High

TSC10H9	Ø1000			£446
TSC08H9	Ø800			£421



Rectangular Stand Height Table

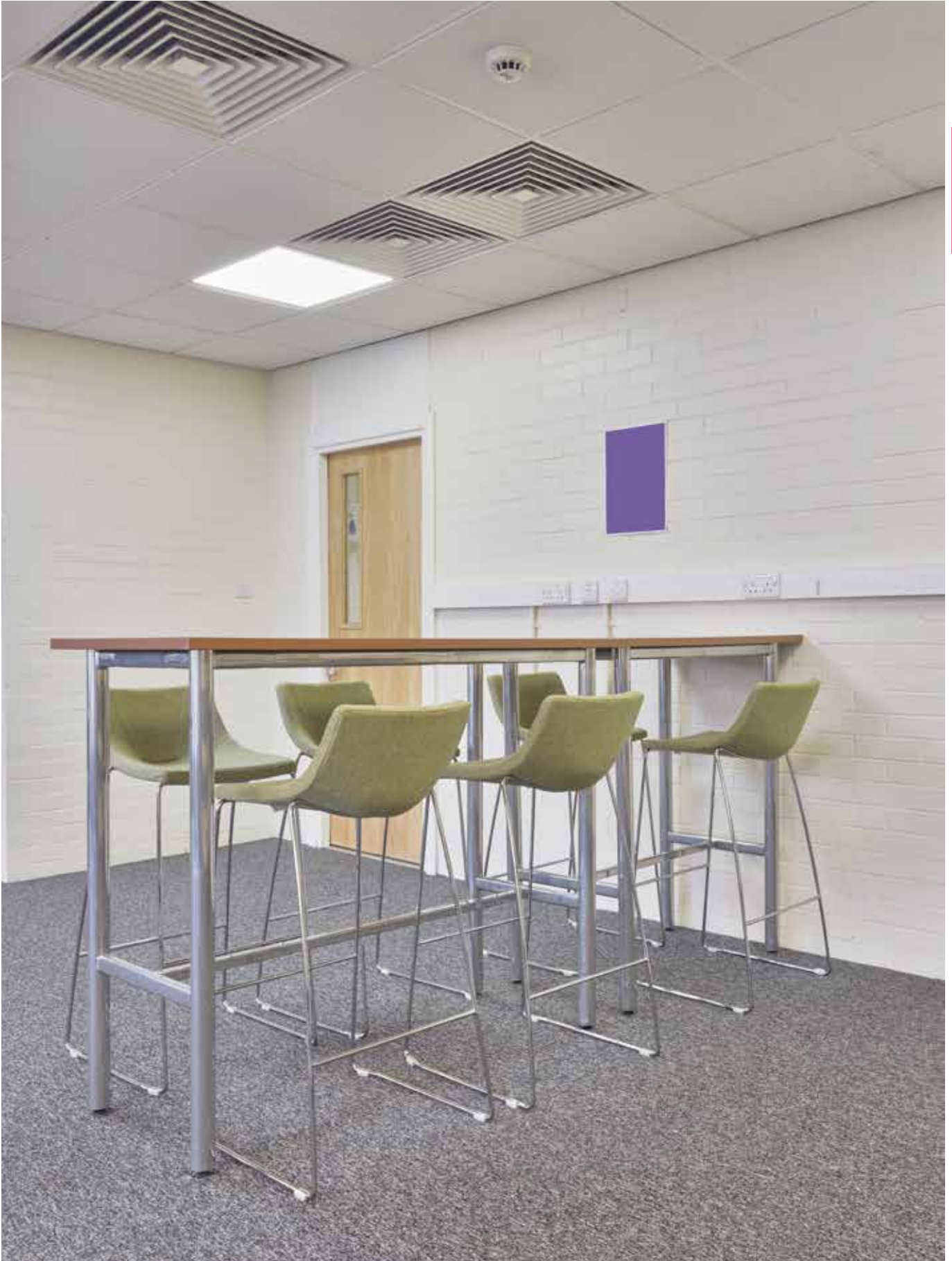

Rectangular Stand Height Table

# GC1 TABLES

10 Year  
Guarantee

GC1 is a family of mobile tables that can easily be reconfigured to suit agile working layouts then folded away and nested, when not in use. They also unique in that they have a simple 'sit-stand' height adjustable feature together with integrated power sockets.

Available Frame Colours

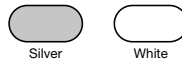

Maximum Load  
Per Top (evenly distributed)



Tables

## Tables with sockets

Code	A	B	Optional (Cable Basket)	Group Z 25mm MFC	Group C 25mm Lam Kiko	Group D 25mm CH Lam Kiko	Group F 25mm Drywipe
GC1C1	2000	1000	MECT20	£2,793	£3,145	£3,222	£3,350
GC1C2	1800	1000	MECT18	£2,781	£3,135	£3,209	£3,336
GC1C3	1600	1000	MECT16	£2,774	£3,130	£3,205	£3,333
GC1C4	1400	1000	MECT14	£2,770	£3,127	£3,200	£3,326
GC1D1	2000	800	MECT20	£2,741	£3,094	£3,172	£3,296
GC1D2	1800	800	MECT18	£2,730	£3,084	£3,159	£3,287
GC1D3	1600	800	MECT16	£2,726	£3,078	£3,153	£3,281
GC1D4	1400	800	MECT14	£2,721	£3,073	£3,150	£3,277





**Mobile to static conversion kit**

Set of four adjusters used to replace castors

GC1KIT1

£14

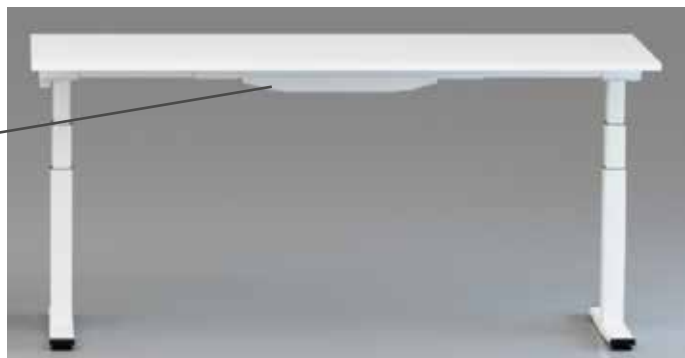
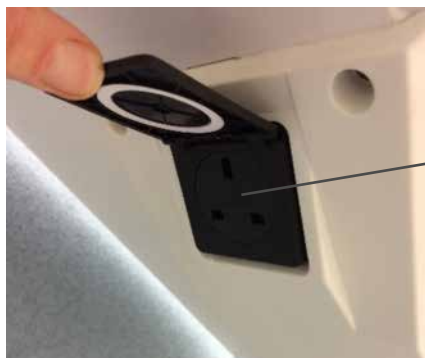
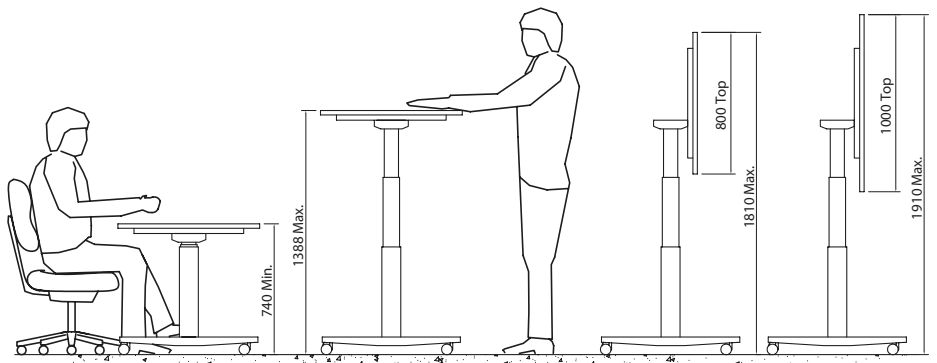

2 UK sockets accessible on the underside of the table.



# GC4 TABLES



GC4 is a select family of tilt-top tables that feature elegant styling on complementary mobile and static frame designs that look great in any working landscape.

The mobile units are designed with the frames positioned to the ends of the table to allow users to sit comfortably to both sides. The static versions have inset frames, allowing users to sit to all sides.

Available Frame Colours

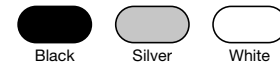

Tables

Code	Dimensions	Optional Cable Tray Code	Group Z 25mm MFC	Group C 25mm Lam Kiko	Group D 25mm CH Lam Kiko
*No linking on 25mm CH Lam top					
<b>Mobile Tilt Top</b>					
GC4A1	1800 x 800	MECT18	£1,042	£1,394	£1,472
GC4A2	1600 x 800	MECT16	£1,014	£1,369	£1,444
GC4A3	1400 x 800	MECT14	£988	£1,341	£1,417
GC4A4	1200 x 800	MECT12	£968	£1,322	£1,395
GC4A5	1000 x 800	MECT10	£957	£1,310	£1,388
GC4B1	1800 x 700	MECT18	£996	£1,349	£1,425
GC4B2	1600 x 700	MECT16	£969	£1,324	£1,399
GC4B3	1400 x 700	MECT14	£940	£1,296	£1,371
GC4B4	1200 x 700	MECT12	£923	£1,277	£1,352
GC4B5	1000 x 700	MECT10	£910	£1,265	£1,341



Mobile Tilt Top



Mobile Tilt Top Nested



Static Inset Leg Tilt Top



Code	Dimensions	Optional Cable Tray Code	Group Z 25mm MFC	Group C 25mm Lam Kiko	Group D 25mm CH Lam Kiko
*No linking on 25mm CH Lam top					
<b>Static Inset Leg Tilt Top</b> Leg frames inset by 300mm each side					
GC4C1	2400 x 800	MECT18	£1,058	£1,409	£1,486
GC4C2	2200 x 800	MECT16	£1,041	£1,386	£1,459
GC4C3	2000 x 800	MECT14	£1,002	£1,357	£1,432
GC4C4	1800 x 800	MECT12	£983	£1,338	£1,412
GC4C5	1600 x 800	MECT10	£972	£1,326	£1,401
GC4D1	2400 x 1000/800	MECT18	£1,086	£1,439	£1,515
GC4D2	2200 x 1000/800	MECT16	£1,059	£1,412	£1,488
GC4D3	2000 x 1000/800	MECT14	£1,029	£1,387	£1,460
GC4D4	1800 x 1000/800	MECT12	£1,011	£1,364	£1,442
GC4D5	1600 x 1000/800	MECT10	£1,000	£1,356	£1,431



Code      A      B      MFC Price

**Suspended Modesty Panels**  
Fits to Appropriate Table Beams

DRCPW18	1750 x 300	£106
DRCPW16	1550 x 300	£99
DRCPW14	1350 x 300	£93
DRCPW12	1150 x 300	£82
DRCPW10	950 x 300	£77
DRCPW08	750 x 300	£71



Code	Table Size	L	W	Price
<b>Optional Cable Baskets</b>				
MECT18	1800	1629	116	£90
MECT16	1600	1426	116	£86
MECT14	1400	1222	116	£85
MECT12	1200	1019	116	£79
MECT10	1000	816	116	£76



Code      Price

**Table Connector Set**  
Pair of link plates & fittings  
\*No linking on 25mm CH Lam top

CONLINK      £27



# TELFORD TILT TOP TABLES



This is our most popular mobile table range. They are simple to use with a robust construction.

- Robust construction. Endframes fitted with castors.
- Simple, one-handed operation.
- Can be moved and nested.
- Available in a selection of footprints.
- 25mm MFC top panels.

Available Frame Colours

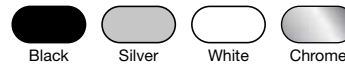

Tables

Code	A	B	White/Silver Black Frame MFC Price	Chrome Frame MFC Price
<b>Rectangular 600mm</b>				
DRMT186Z	1800	x 600	£618	£758
DRMT166Z	1600	x 600	£593	£720
DRMT146Z	1400	x 600	£563	£698
DRMT126Z	1200	x 600	£550	£665
DRMT106Z	1000	x 600	£541	£659
DRMT086Z	800	x 600	£531	£651



Code	A	B	C	White/Silver Black Frame MFC Price	Chrome Frame MFC Price
<b>Rectangular 800mm</b>					
DRMT188Z	1800	x 800		£698	£844
DRMT168Z	1600	x 800		£670	£815
DRMT148Z	1400	x 800		£644	£795
DRMT128Z	1200	x 800		£625	£762
DRMT108Z	1000	x 800		£613	£746
DRMT088Z	800	x 800		£603	£733

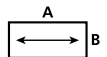

Code	A	B	White/Silver Black Frame MFC Price	Chrome Frame MFC Price
<b>Rectangular 700mm</b>				
DRMT187Z	1800	x 700	£653	£797
DRMT167Z	1600	x 700	£622	£760
DRMT147Z	1400	x 700	£600	£734
DRMT127Z	1200	x 700	£578	£707
DRMT107Z	1000	x 700	£570	£698
DRMT087Z	800	x 700	£559	£683



Code	A	B	C	White/Silver Black Frame MFC Price	Chrome Frame MFC Price
<b>Trapezium</b>					
DTMT16Z	1600	x 800	x 800	£670	£815
DTMT14Z	1400	x 700	x 700	£622	£760

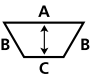

Rectangular Tilt Top Tables

10 Year  
Guarantee

# TELFORD TILT TOP TABLES

Code      A      B

### Semi-Circular

DSMT16Z     $\phi$ 1600 x 800  
DSMT14Z     $\phi$ 1400 x 700

White/Silver Black Frame MFC Price	Chrome Frame MFC Price
£670	£815
£622	£760



### Circular

DCMT12Z     $\phi$ 1200  
DCMT10Z     $\phi$ 1000

£674	£815
£622	£760



Rectangular Tables Nested

Code      A      B

### Suspended Modesty Panels

Fits to Appropriate Table Beams

DRCPW18	1750 x 300	£106
DRCPW16	1550 x 300	£99
DRCPW14	1350 x 300	£93
DRCPW12	1150 x 300	£82
DRCPW10	950 x 300	£77
DRCPW08	750 x 300	£71



Code	Table Size	L	W	Price
<b>Optional Cable Baskets</b>				
MECT18	1800	1629	116	£90
MECT16	1600	1426	116	£86
MECT14	1400	1222	116	£85
MECT12	1200	1019	116	£79
MECT10	1000	816	116	£76



Code      Price

### Table Connector Set

Pair of link plates & fittings  
\*No linking on 25mm CH Lam top

CONLINK      £27



Rectangular Tilt Top Tables

# TELFORD FIXED TOP TABLES



Complementing our popular Tilt Top range, this Fixed Top static table offers the perfect solution for configured layouts or stand alone applications.

- Robust construction. Endframes fitted with levelling feet.
- Complements our Tilt Top range.
- Available in a selection of footprints.
- 25mm MFC top panels.

Available Frame Colours

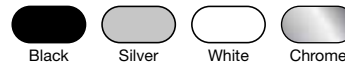

Tables

Code	A	B	C	White/Silver Black Frame MFC Price	Chrome Frame MFC Price
<b>Rectangular 800mm</b>					
DRFT168Z	1600	x	800	£612	£757
DRFT148Z	1400	x	800	£593	£730
DRFT128Z	1200	x	800	£563	£700
DRFT108Z	1000	x	800	£555	£690
DRFT088Z	800	x	800	£543	£676



Code	A	B	White/Silver Black Frame MFC Price	Chrome Frame MFC Price	
<b>Rectangular Tables 700mm</b>					
DRFT167Z	1600	x	700	£574	£699
DRFT147Z	1400	x	700	£547	£674
DRFT127Z	1200	x	700	£526	£652
DRFT107Z	1000	x	700	£518	£637
DRFT087Z	800	x	700	£508	£627

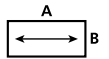

Code	A	B	C	White/Silver Black Frame MFC Price	Chrome Frame MFC Price		
<b>Trapezium</b>							
DTFT16Z	1600	x	800	x	800	£614	£757
DTFT14Z	1400	x	700	x	700	£574	£699



Code	A	B	MFC Price	
<b>Suspended Modesty Panels</b> Fits to Appropriate Table Beams				
DRCPW16	1550	x	300	£99
DRCPW14	1350	x	300	£93
DRCPW12	1150	x	300	£82
DRCPW10	950	x	300	£77
DRCPW08	750	x	300	£71

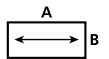

Code	A	B	White/Silver Black Frame MFC Price	Chrome Frame MFC Price	
<b>Semi Circular</b>					
DSFT16Z	ø1600	x	800	£614	£757
DSFT14Z	ø1400	x	700	£574	£699



Code	A	B	White/Silver Black Frame MFC Price	Chrome Frame MFC Price
<b>Circular Tables</b>				
DCFT12Z	ø1200		£621	£758
DCFT10Z	ø1000		£570	£699



Code	MFC Price
<b>Table Connector Set</b> Pair of link plates & fittings	
CONLINK	£27



Rectangular Tilt Top Tables

# TELFORD FOLDING LEG TABLES

- 'I' frame or cow horn frame folding leg mechanism with robust construction.
- Tables fold flat for storage.
- Storage trolley designed to fit through single door.
- Available with a choice of Black, Grey, Silver, White or Chrome legs.
- Cow horn legs designed for seating at all sides.
- 25mm MFC top panels.



'I' Frame Table

Cow Horn Table

Examples of configurations

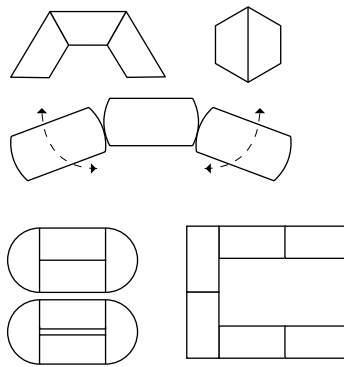

TFLT

Tables

'I' Frame Code	Cow Horn Code	A	B	MFC Price
<b>Rectangular</b>				
T818FZ	C818FZ	1800 x 800		£538
T816FZ	C816FZ	1600 x 800		£475
T814FZ	C814FZ	1400 x 800		£447
T812FZ	C812FZ	1200 x 800		£425
T718FZ	N/A	1800 x 700		£517
T716FZ	N/A	1600 x 700		£446
T714FZ	N/A	1400 x 700		£416
T712FZ	N/A	1200 x 700		£396

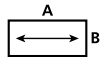

'I' Frame Code	Cow Horn Code	A	B	C	MFC Price
<b>Convex Shape</b>					
T818CFZ	C818CFZ	1800 x 800			£578
T816CFZ	C816CFZ	1600 x 800			£542
T714CFZ	N/A	1400 x 700			£512
<b>Trapezium</b>					
TT816FZ	CTT816FZ	1600 x 800	x 800		£549
TT714FZ	N/A	1400 x 700	x 700		£517
<b>Semi-Circular</b>					
TSC16FZ	CSC16FZ	ø1600 x 800			£530
TSC14FZ	N/A	ø1400 x 700			£498

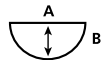
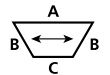
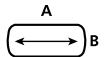

Code	Dimensions	MFC Price
<b>Folding Leg Trolley</b>		
Accepts up to 5 tables folded, available in Black or Grey finish.		
TFLT	1540 x 650 x 960 (Overall size)	£578
	1340 x 600 x 450 (Internal size)	



Cow Horn Rectangular Table

# TELFORD ADAPT TABLES



- Robustly constructed with continuous welded frame.
- Available in a variety of sizes and footprints.
- 727mm High with 25mm MFC top panels.

Surcharge for Pastel Paint – £33 per item

CONLINK Table Connector Set £27

Examples of configurations

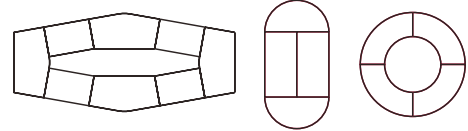

Tables

Code            A            B            MFC Price

## 800mm Rectangular

NT816RZ	1600 x 800	£412
NT814RZ	1400 x 800	£386
NT812RZ	1200 x 800	£371
NT808RZ	800 x 800	£336



## 700mm Rectangular

NT716RZ	1600 x 700	£403
NT714RZ	1400 x 700	£377
NT712RZ	1200 x 700	£361
NT708RZ	700 x 700	£325



## Trapezium

NT816TZ	1600 x 800 x 800	£505
NT714TZ	1400 x 700 x 700	£489



## Semi-Circular

NT816SZ	1600 x 800	£505
NT714SZ	1400 x 700	£489



## Shell

NT816LZ	1711 x 800 x R1210	£658
NT714LZ	1570 x 700 x R1110	£625



## Arc

NT816AZ	1600 x 800	£633
NT714AZ	1400 x 700	£600



## Pentagonal

NT816PZ	1600 x 800	£633
NT714PZ	1400 x 700	£600

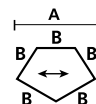

## 700mm Rectangular

NT16CZ	Ø1600	£514
NT14CZ	Ø1400	£488
NT12CZ	Ø1200	£444
NT10CZ	Ø1000	£412



## Suspended Modesty Panels

NTCPW16	1600 x 300	£99
NTCPW14	1400 x 300	£93
NTCPW12	1200 x 300	£82





# TELFORD SEGMENT TABLES

- Mobile Segment tables are the perfect choice for adaptive workspaces.
- Compact but deceptively strong, available with either Fixed or Tilt-top for nesting.

**Only 18mm MFC Top Panels on Segment tables.**

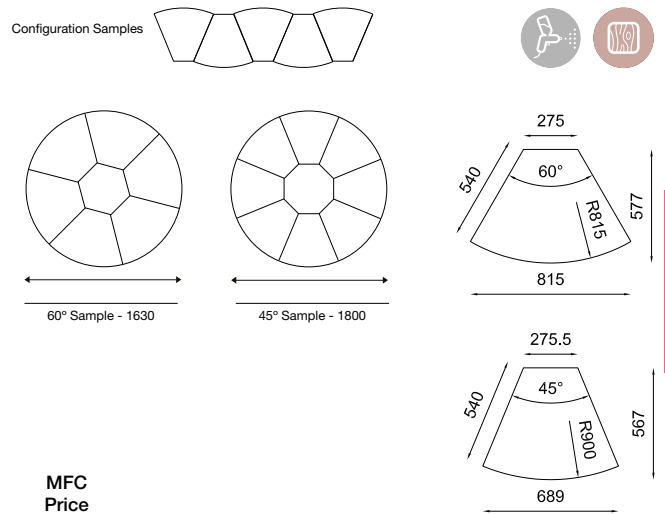

Code	W	D	H	MFC Price		
<b>45° Fixed Top</b>						
TMSF45	689	x	567	x	720	£293
<b>60° Fixed Top</b>						
TMSF60	815	x	577	x	720	£293

Code	W	D	H	Height when Tilted	MFC Price		
<b>45° Tilt Top</b>							
TMST45	689	x	567	x	720	1150	£468
<b>60° Tilt Top</b>							
TMST60	815	x	577	x	720	1160	£468
<b>Linking Kit</b>							
TMSLK							£33

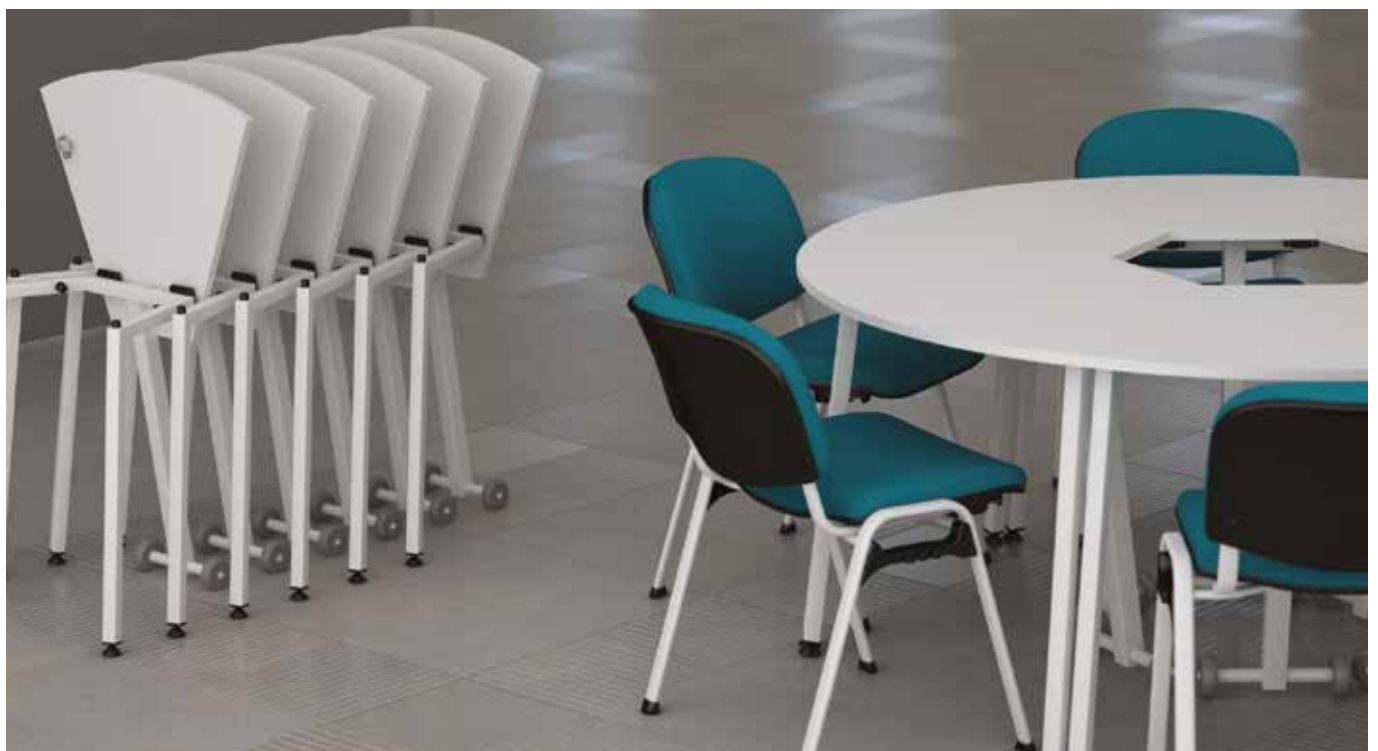

45° Tilt Top Segment Tables

# MULTI-PURPOSE STATIC BTC & CTC TABLES

25 Year Structural Guarantee

A range of multi-purpose tables with fully-welded steel frames that combine aesthetic appeal with strength and stability.

- Available in a selection of footprints and finishes.
- Available with either round or square legged options.
- 25mm MFC top panels.



Tables

Ø35mm Circular Leg	40mm Square Leg	A	B	MFC Price
--------------------	-----------------	---	---	-----------

### Rectangular 800mm Deep

CTC188Z	BTC188Z	1800 x 800	£434
CTC168Z	BTC168Z	1600 x 800	£407
CTC148Z	BTC148Z	1400 x 800	£376
CTC138Z	BTC138Z	1300 x 800	£357
CTC128Z	BTC128Z	1200 x 800	£342
CTC108Z	BTC108Z	1000 x 800	£325
CTC088Z	BTC088Z	800 x 800	£316



### Rectangular 700mm Deep

CTC187Z	BTC187Z	1800 x 700	£393
CTC167Z	BTC167Z	1600 x 700	£368
CTC147Z	BTC147Z	1400 x 700	£341
CTC137Z	BTC137Z	1300 x 700	£325
CTC127Z	BTC127Z	1200 x 700	£314
CTC107Z	BTC107Z	1000 x 700	£289
CTC087Z	BTC087Z	800 x 700	£272
CTC077Z	BTC077Z	700 x 700	£269



### Rectangular 600mm & 650mm Deep

CTC186Z	BTC186Z	1800 x 600	£355
CTC166Z	BTC166Z	1600 x 600	£326
CTC146Z	BTC146Z	1400 x 600	£304
CTC136Z	BTC136Z	1300 x 600	£293
CTC126Z	BTC126Z	1200 x 600	£285
CTC106Z	BTC106Z	1000 x 600	£255
CTC086Z	BTC086Z	800 x 600	£253
CTC065Z	BTC065Z	650 x 650	£228
CTC066Z	BTC066Z	600 x 600	£228



Ø35mm Circular Leg	40mm Square Leg	A	B	C	MFC Price
--------------------	-----------------	---	---	---	-----------

### Trapezium

CTT188Z	BTT188Z	1800 x 800	1000	£527
CTT168Z	BTT168Z	1600 x 800	800	£496
CTT147Z	BTT147Z	1400 x 700	700	£448
CTT128Z	BTT128Z	1200 x 800	400	£403
CTT126Z	BTT126Z	1200 x 600	600	£368



### Semi-circular

CSC18Z	BSC18Z	Ø1800 x 900	£527
CSC16Z	BSC16Z	Ø1600 x 800	£496
CSC14Z	BSC14Z	Ø1400 x 700	£448
CSC12Z	BSC12Z	Ø1200 x 600	£403



### Circular

CCC16Z	BCC16Z	Ø1600	£591
CCC14Z	BCC14Z	Ø1400	£560
CCC12Z	BCC12Z	Ø1200	£527
CCC10Z	BCC10Z	Ø1000	£488
CCC08Z	BCC08Z	Ø800	£455



Rectangular BTC Static Tables

# MULTI-PURPOSE MOBILE BTC & CTC TABLES

A range of mobile multi-purpose tables with fully-welded steel frames that combine aesthetic appeal with strength and stability.

- Fitted with lockable castors.
- Available in a selection of footprints and finishes.
- Available with either round or square legged options.
- 25mm MFC top panels.



Ø35mm Circular Leg	40mm Square Leg	A	B	MFC Price
<b>Rectangular 800mm Deep</b>				
CTC188M	BTC188M	1800	800	£484
CTC168M	BTC168M	1600	800	£455
CTC148M	BTC148M	1400	800	£424
CTC138M	BTC138M	1300	800	£409
CTC128M	BTC128M	1200	800	£389
CTC108M	BTC108M	1000	800	£376
CTC088M	BTC088M	800	800	£367

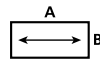

Ø35mm Circular Leg	40mm Square Leg	A	B	MFC Price
<b>Rectangular 700mm Deep</b>				
CTC187M	BTC187M	1800	700	£443
CTC167M	BTC167M	1600	700	£414
CTC147M	BTC147M	1400	700	£388
CTC137M	BTC137M	1300	700	£376
CTC127M	BTC127M	1200	700	£362
CTC107M	BTC107M	1000	700	£339
CTC087M	BTC087M	800	700	£320
CTC077M	BTC077M	700	700	£318

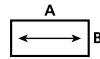

Ø35mm Circular Leg	40mm Square Leg	A	B	MFC Price
<b>Rectangular 600mm &amp; 650mm Deep</b>				
CTC186M	BTC186M	1800	600	£405
CTC166M	BTC166M	1600	600	£377
CTC146M	BTC146M	1400	600	£353
CTC136M	BTC136M	1300	600	£343
CTC126M	BTC126M	1200	600	£335
CTC106M	BTC106M	1000	600	£303
CTC086M	BTC086M	800	600	£300
CTC065M	BTC065M	650	650	£276
CTC066M	BTC066M	600	600	£276

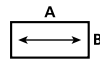

Ø35mm Circular Leg	40mm Square Leg	A	B	C	MFC Price
<b>Trapezium</b>					
CTT188M	BTT188M	1800	800	1000	£575
CTT168M	BTT168M	1600	800	800	£545
CTT147M	BTT147M	1400	700	700	£497
CTT128M	BTT128M	1200	800	400	£451
CTT126M	BTT126M	1200	600	600	£414

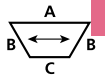

Ø35mm Circular Leg	40mm Square Leg	A	B	MFC Price
<b>Semi-Circular</b>				
CSC18M	BSC18M	Ø1800	900	£575
CSC16M	BSC16M	Ø1600	800	£545
CSC14M	BSC14M	Ø1400	700	£497
CSC12M	BSC12M	Ø1200	600	£451

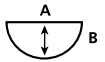

Ø35mm Circular Leg	40mm Square Leg	A	MFC Price
<b>Circular</b>			
CCC16M	BCC16M	Ø1600	£638
CCC14M	BCC14M	Ø1400	£609
CCC12M	BCC12M	Ø1200	£575
CCC10M	BCC10M	Ø1000	£534
CCC08M	BCC08M	Ø800	£505



Square CTC Mobile Tables

# MULTI-PURPOSE STC TABLES

25 Year Structural Guarantee

A range of multi-purpose tables with fully-welded steel frames that combine simplicity with strength and stability.

- Available in a selection of footprints.
- Rectangular tables can be spirally stacked.
- 25mm MFC top panels.



25mm Square Leg



Tables

Code                    A                    B                    MFC Price

### Rectangular 800mm Deep

STC188Z	1800 x	800	£326
STC168Z	1600 x	800	£310
STC148Z	1400 x	800	£282
STC138Z	1300 x	800	£266
STC128Z	1200 x	800	£252
STC108Z	1000 x	800	£235
STC088Z	800 x	800	£228



### Rectangular 700mm Deep

STC187Z	1800 x	700	£303
STC167Z	1600 x	700	£282
STC147Z	1400 x	700	£256
STC137Z	1300 x	700	£240
STC127Z	1200 x	700	£229
STC107Z	1000 x	700	£214
STC087Z	800 x	700	£205
STC077Z	700 x	700	£201



### Rectangular 600mm & 650mm Deep

STC186Z	1800 x	600	£262
STC166Z	1600 x	600	£236
STC146Z	1400 x	600	£220
STC136Z	1300 x	600	£207
STC126Z	1200 x	600	£195
STC106Z	1000 x	600	£185
STC086Z	800 x	600	£167
STC065Z	650 x	650	£155
STC066Z	600 x	600	£155



Code                    A                    B                    C                    MFC Price

### Trapezium

TT188Z	1800 x	800 x	1000	£424
TT168Z	1600 x	800 x	800	£377
TT147Z	1400 x	700 x	700	£342
TT128Z	1200 x	800 x	400	£287
TT126Z	1200 x	600 x	600	£241



### Semi-Circular

SCT18Z	Ø1800 x	900	£419
SCT16Z	Ø1600 x	800	£374
SCT14Z	Ø1400 x	700	£336
SCT12Z	Ø1200 x	600	£265



### Circular

FTC16Z	Ø1600	£486
FTC14Z	Ø1400	£465
FTC12Z	Ø1200	£446
FTC10Z	Ø1000	£405
FTC08Z	Ø800	£376



Code                    Description                    W                    D                    H                    MFC Price

### Reception Tables Fully Welded 25mm Square Four Legged 25mm MFC top panels.

STC104Z	Rectangular	1000 x	600 x	400	£186
STC064Z	Square	600 x	600 x	400	£162
STE104Z	Oval	1000 x	600 x	400	£312
FTC084Z	Circular	Ø800	x	400	£271
FTC064Z	Circular	Ø600	x	400	£196



Rectangular STC Table

- Selected additional Tables for meeting and conference requirements.
- Available in a variety of sizes and footprints.
- 727mm High with 25mm MFC top panels unless otherwise stated.



Code            A            B            Price

**800mm Flush Frame Rectangular Table**  
Continuous welded Steel Frame

CON18Z	1800 x 800	£436
CON16Z	1600 x 800	£384
CON14Z	1400 x 800	£366
CON12Z	1200 x 800	£348



**800mm Inset Frame Rectangular Table**  
Continuous welded Steel Frame

CON18EZ	1800 x 800	£436
CON16EZ	1600 x 800	£384
CON14EZ	1400 x 800	£366
CON12EZ	1200 x 800	£348



**800mm D-End Frame Table**  
Continuous welded Steel Frame

CON20DZ	2000 x 800	£512
CON18DZ	1800 x 800	£459
CON16DZ	1600 x 800	£407



Code            Description            W            D            H            MFC Price

**Fully Welded 50mm Diameter Circular Four Legged**  
25mm MFC top panels.

PR106Z	Rectangular	1000 x 600 x 400	£387
PR6Z	Square	600 x 600 x 400	£256
PR7Z	Boat shaped	1000 x 600 x 400	£387
SAVCT2	Oval	1000 x 600 x 400	£387
PC8Z	Circular	Ø800 x 400	£447
PC6Z	Circular	Ø600 x 400	£320

Code            A            MFC Price

**Circular Meeting Tables -  
ø50mm Circular Legs**

TC16RZ	Ø1600	£516
TC14RZ	Ø1400	£489
TC12RZ	Ø1200	£457
TC10RZ	Ø1000	£413
TC08RZ	Ø800	£390



**Circular Meeting Tables -  
Cross Frame**

CCT16Z	Ø1600	£660
CCT14Z	Ø1400	£612
CCT12Z	Ø1200	£574
CCT10Z	Ø1000	£514
CCT08Z	Ø800	£463



PR7Z

PC6Z

PR6Z



Circular Meeting Table with Cross Frame

- Black Cross Base design.
- Available in Circular, Square and Rectangular footprints.



Code	Top Shape	Top Size	Group Z 25mm MFC	Group B 36mm MFC	Group C 25mm Lam Kiko	Group D 25mm CH Lam Kiko
<b>Coffee - 455mm High</b>						
LTA06CR	Circular	ø600	£261	£474	£635	£720
LTA66R	Square	600 x 600	£253	£464	£625	£705



### Lounge - 575mm High

LTA06CL	Circular	ø600	£278	£493	£653	£734
LTA07CL	Circular	ø700	£299	£512	£670	£754
LTA08CL	Circular	ø800	£322	£533	£696	£781
LTA09CL	Circular	ø900	£339	£553	£710	£794
LTA10CL	Circular	ø1000	£361	£574	£732	£817
LTA66L	Square	600 x 600	£272	£485	£644	£727
LTA77L	Square	700 x 700	£291	£504	£665	£748
LTA88L	Square	800 x 800	£312	£526	£686	£766



### Dining - 745mm High

LTA06CD	Circular	ø600	£278	£493	£653	£734
LTA07CD	Circular	ø700	£299	£512	£670	£754
LTA08CD	Circular	ø800	£322	£533	£696	£781
LTA09CD	Circular	ø900	£339	£553	£710	£794
LTA10CD	Circular	ø1000	£361	£574	£732	£817
LTA66D	Square	600 x 600	£272	£485	£644	£727
LTA77D	Square	700 x 700	£291	£504	£665	£748
LTA88D	Square	800 x 800	£312	£526	£686	£766



### Twin Pedestal Dining - 745mm High

LTA127D	Rectangular	1200 x 700	£448	£664	£825	£905
LTA147D	Rectangular	1400 x 700	£482	£694	£856	£937
LTA128D	Rectangular	1200 x 800	£458	£670	£832	£912
LTA148D	Rectangular	1400 x 800	£493	£704	£865	£947



### Mid Poseur - 905mm High

LTA06CMP	Circular	ø600	£330	£542	£703	£787
LTA66MP	Square	600 x 600	£322	£533	£696	£781

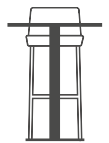

### Poseur - 1125mm High

LTA06CP	Circular	ø600	£330	£542	£703	£787
LTA66P	Square	600 x 600	£322	£533	£696	£781

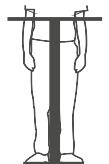



- Chrome Cross Base design.
- Available in Circular, Square and Rectangular footprints.



Code	Top Shape	Top Size	Group Z 25mm MFC	Group B 36mm MFC	Group C 25mm Lam Kiko	Group D 25mm CH Lam Kiko
<b>Coffee - 455mm High</b>						
LTC06CR	Circular	ø600	£371	£580	£742	£827
LTC66R	Square	600 x 600	£361	£574	£732	£817



### Lounge - 575mm High

LTC06CL	Circular	ø600	£388	£602	£762	£844
LTC07CL	Circular	ø700	£411	£625	£786	£866
LTC08CL	Circular	ø800	£429	£643	£803	£887
LTC09CL	Circular	ø900	£448	£664	£825	£905
LTC10CL	Circular	ø1000	£469	£684	£842	£925
LTC66L	Square	600 x 600	£380	£594	£754	£835
LTC77L	Square	700 x 700	£401	£610	£769	£856
LTC88L	Square	800 x 800	£419	£633	£792	£875



### Dining - 745mm High

LTC06CD	Circular	ø600	£388	£602	£762	£844
LTC07CD	Circular	ø700	£411	£625	£786	£866
LTC08CD	Circular	ø800	£429	£643	£803	£887
LTC09CD	Circular	ø900	£448	£664	£825	£905
LTC10CD	Circular	ø1000	£469	£684	£842	£925
	5 star base					
LTC66D	Square	600 x 600	£380	£594	£754	£835
LTC77D	Square	700 x 700	£401	£610	£769	£856
LTC88D	Square	800 x 800	£419	£633	£792	£875



### Twin Pedestal Dining - 745mm High

LTC127D	Rectangular	1200 x 700	£632	£842	£1,005	£1,086
LTC147D	Rectangular	1400 x 700	£664	£875	£1,037	£1,117
LTC128D	Rectangular	1200 x 800	£637	£852	£1,011	£1,093
LTC148D	Rectangular	1400 x 800	£669	£880	£1,043	£1,128

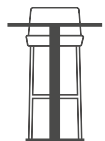

### Mid Poseur - 905mm High

LTC06CMP	Circular	ø600	£442	£654	£816	£897
LTC66MP	Square	600 x 600	£429	£643	£803	£887



### Poseur - 1125mm High

LTC06CP	Circular	ø600	£442	£654	£816	£897
LTC66P	Square	600 x 600	£429	£643	£803	£887

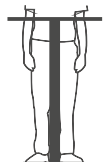



10 Year  
Guarantee

# LTC TABLES

Tables



- Chrome Trumpet Base design.
- Available in Circular and Square footprints.



Tables

Code	Top Shape	Top Size	Group Z 25mm MFC	Group B 36mm MFC	Group C 25mm Lam Kiko	Group D 25mm CH Lam Kiko
<b>Coffee - 455mm High</b>						
LTD06CR	Circular	ø600	£455	£668	£829	£910
LTD66R	Square	600 x 600	£432	£644	£804	£888
<b>Lounge - 575mm High</b>						
LTD06CL	Circular	ø600	£477	£690	£850	£932
LTD07CL	Circular	ø700	£495	£706	£868	£952
LTD08CL	Circular	ø800	£514	£727	£888	£970
LTD09CL	Circular	ø900	£538	£752	£910	£994
LTD10CL	Circular	ø1000	£576	£789	£951	£1,032
LTD66L	Square	600 x 600	£421	£635	£795	£877
LTD77L	Square	700 x 700	£468	£680	£841	£924
LTD88L	Square	800 x 800	£508	£722	£879	£962
<b>Dining - 745mm High</b>						
LTD06CD	Circular	ø600	£477	£690	£850	£932
LTD07CD	Circular	ø700	£495	£706	£868	£952
LTD08CD	Circular	ø800	£514	£727	£888	£970
LTD09CD	Circular	ø900	£538	£752	£910	£994
LTD10CD	Circular	ø1000	£576	£789	£951	£1,032
LTD66D	Square	600 x 600	£421	£635	£795	£877
LTD77D	Square	700 x 700	£468	£680	£841	£924
LTD88D	Square	800 x 800	£508	£722	£879	£962
<b>Mid Poseur - 905mm High</b>						
LTD06CMP	Circular	ø600	£527	£738	£899	£980
LTD66MP	Square	600 x 600	£516	£728	£891	£972
<b>Poseur - 1125mm High</b>						
LTD06CP	Circular	ø600	£527	£738	£899	£980
LTD66P	Square	600 x 600	£516	£728	£891	£972

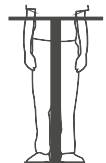
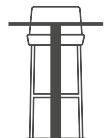
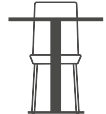

10 Year  
Guarantee

# LTD TABLES

Tables

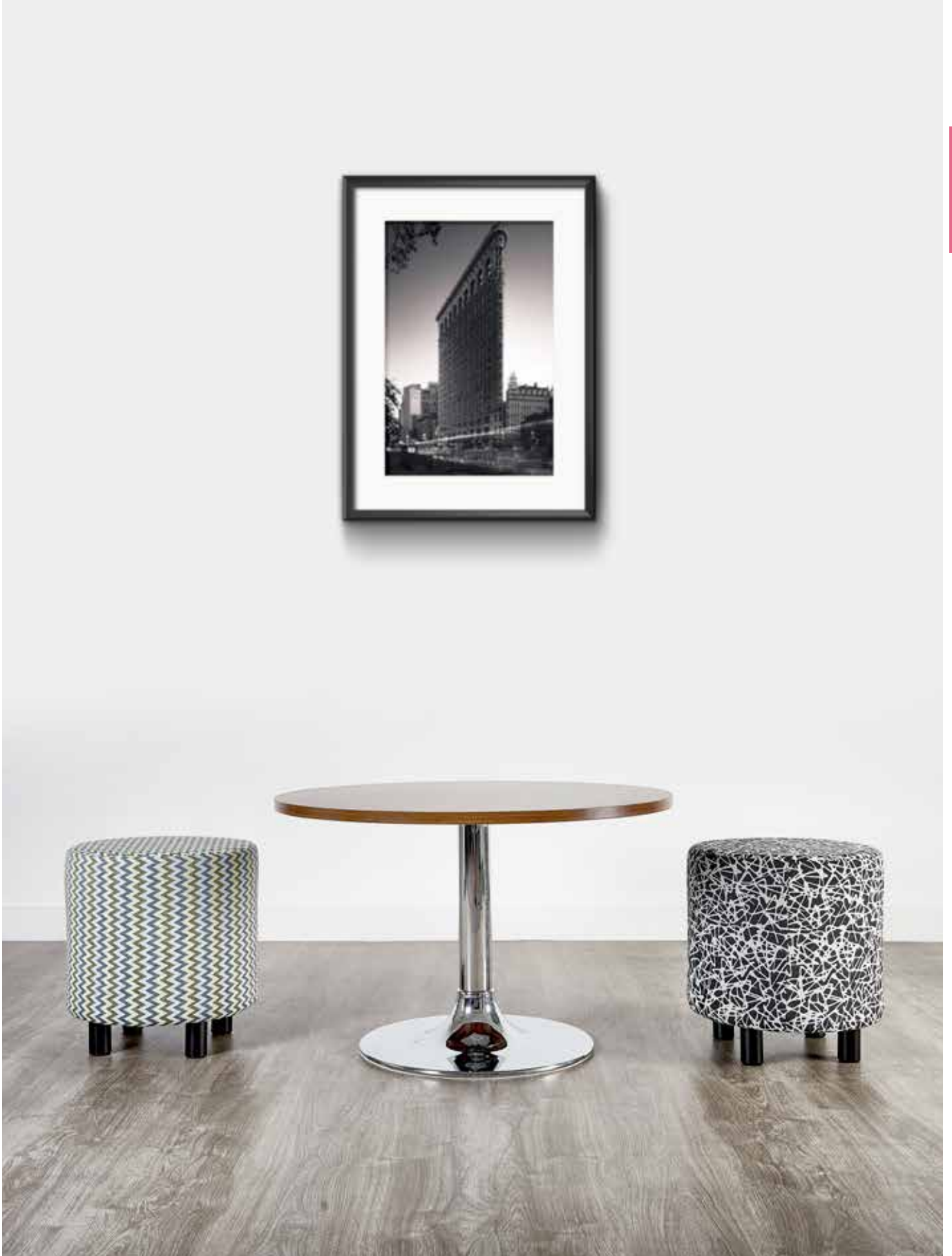

# LTF BLACK TABLES

10 Year  
Guarantee

- Black Flat Base design.
- Available in Circular, Square and Rectangular footprints.



Tables

Code	Base & Top shape	Top Size	Group Z 25mm MFC	Group B 36mm MFC	Group C 25mm Lam Kiko	Group D 25mm CH Lam Kiko
<b>Coffee - 455mm High</b>						
LTFB06R	Circular	Ø600	£368	£578	£739	£825
LTFB66R	Square	600 x 600	£356	£571	£729	£814
<b>Coffee Twin Pedestal - 455mm High</b>						
LTFB127R	Rectangular	1200 x 700	£694	£906	£1,068	£1,150
LTFB147R	Rectangular	1400 x 700	£810	£1,023	£1,182	£1,265
LTFB128R	Rectangular	1200 x 800	£792	£1,006	£1,166	£1,247
LTFB148R	Rectangular	1400 x 800	£828	£1,041	£1,201	£1,282
<b>Lounge - 575mm High</b>						
LTFB06CL	Circular	Ø600	£389	£603	£764	£845
LTFB07CL	Circular	Ø700	£411	£625	£786	£866
LTFB08CL	Circular	Ø800	£428	£641	£802	£884
LTFB66L	Square	600 x 600	£381	£595	£756	£836
LTFB77L	Square	700 x 700	£402	£612	£771	£857
LTFB88L	Square	800 x 800	£419	£633	£792	£875
<b>Lounge Twin Pedestal Base - 575mm High</b>						
LTFB127L	Rectangular	1200 x 700	£816	£1,026	£1,187	£1,272
LTFB147L	Rectangular	1400 x 700	£841	£1,053	£1,213	£1,297
LTFB128L	Rectangular	1200 x 800	£826	£1,038	£1,198	£1,279
LTFB148L	Rectangular	1400 x 800	£852	£1,066	£1,224	£1,307
<b>Dining - 745mm High</b>						
LTFB06CD	Circular	Ø600	£389	£603	£764	£845
LTFB07CD	Circular	Ø700	£411	£625	£786	£866
LTFB08CD	Circular	Ø800	£428	£641	£802	£884
LTFB66D	Square	600 x 600	£381	£595	£756	£836
LTFB77D	Square	700 x 700	£402	£612	£771	£857
LTFB88D	Square	800 x 800	£419	£633	£792	£875
<b>Dining Twin Pedestal Base - 745mm High</b>						
LTFB127D	Rectangular	1200 x 700	£816	£1,026	£1,187	£1,272
LTFB147D	Rectangular	1400 x 700	£841	£1,053	£1,213	£1,297
LTFB128D	Rectangular	1200 x 800	£826	£1,038	£1,198	£1,279
LTFB148D	Rectangular	1400 x 800	£852	£1,066	£1,224	£1,307
<b>Mid Poseur - 905mm High</b>						
LTFB06CMP	Circular	Ø600	£440	£652	£811	£895
LTFB66MP	Square	600 x 600	£428	£641	£802	£884
<b>Poseur - 1105mm High</b>						
LTFB06CP	Circular	Ø600	£440	£652	£811	£895
LTFB66P	Square	600 x 600	£428	£641	£802	£884
<b>Twin Pedestal Poseur - 1105mm High</b>						
LTFB127P	Rectangular	1200 x 700	£891	£1,102	£1,261	£1,344
LTFB147P	Rectangular	1400 x 700	£916	£1,131	£1,288	£1,371
LTFB128P	Rectangular	1200 x 800	£897	£1,108	£1,272	£1,354
LTFB148P	Rectangular	1400 x 800	£927	£1,138	£1,300	£1,386

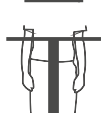
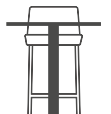
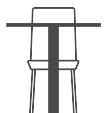

# LTF BLACK TABLES

10 Year  
Guarantee

Tables

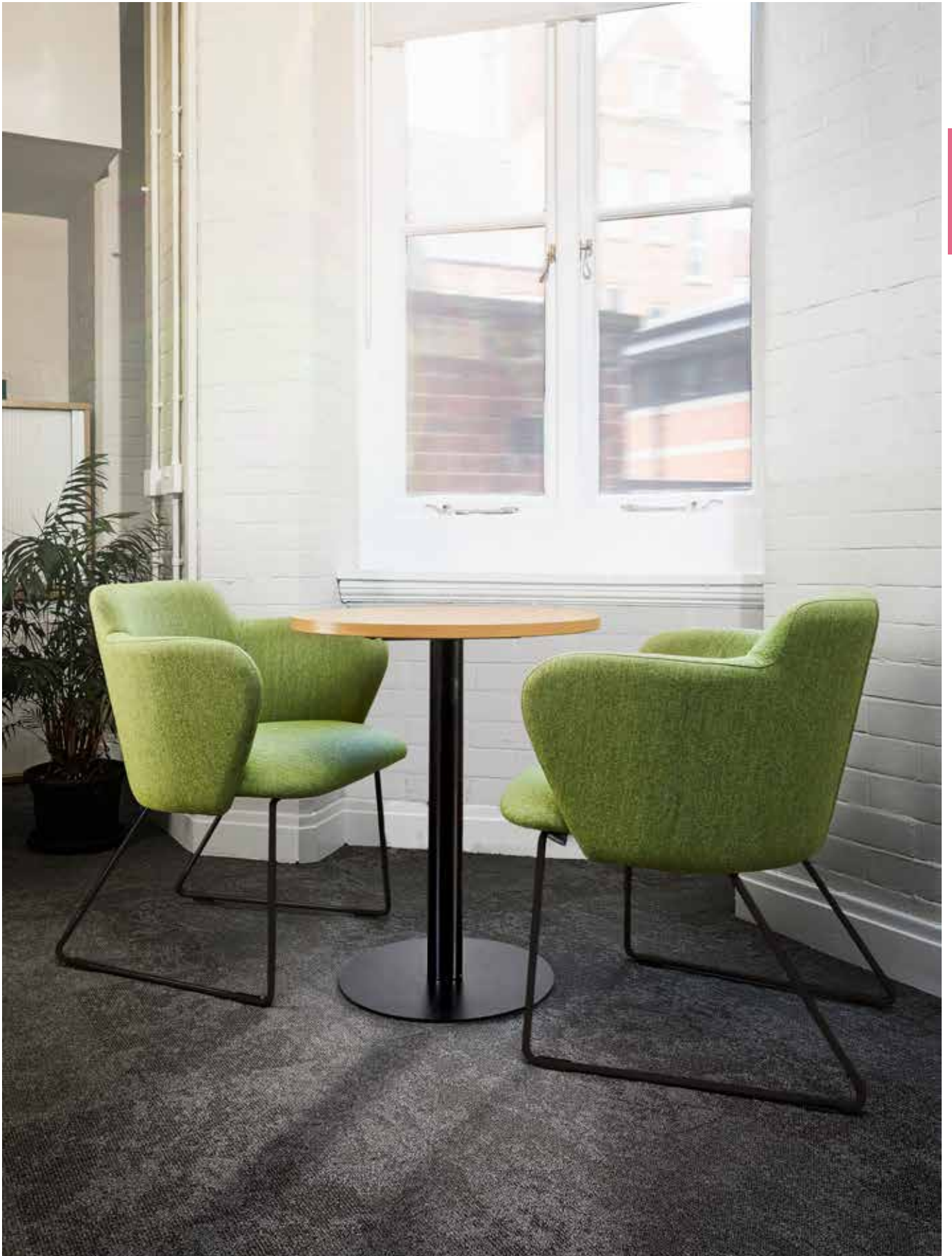

# LTF STEEL TABLES



- Stainless Steel Flat Base design.
- Available in Circular, Square and Rectangular footprints.



Tables

Code	Base & Top shape	Top Size	Group Z 25mm MFC	Group B 36mm MFC	Group C 25mm Lam Kiko	Group D 25mm CH Lam Kiko
<b>Coffee - 455mm High</b>						
LTF506R	Circular	Ø600	£600	£811	£972	£1,053
LTF566R	Square	600 x 600	£580	£795	£956	£1,039
<b>Coffee Twin Pedestal - 455mm High</b>						
LTF5127R	Rectangular	1200 x 700	£946	£1,161	£1,320	£1,401
LTF5147R	Rectangular	1400 x 700	£980	£1,195	£1,356	£1,435
LTF5128R	Rectangular	1200 x 800	£962	£1,018	£1,338	£1,421
LTF5148R	Rectangular	1400 x 800	£997	£1,211	£1,371	£1,454
<b>Lounge - 575mm High</b>						
LTF506CL	Circular	Ø600	£625	£835	£996	£1,081
LTF507CL	Circular	Ø700	£641	£856	£1,014	£1,098
LTF508CL	Circular	Ø800	£664	£875	£1,037	£1,117
LTF566L	Square	600 x 600	£612	£827	£985	£1,069
LTF577L	Square	700 x 700	£634	£845	£1,007	£1,088
LTF588L	Square	800 x 800	£652	£864	£1,024	£1,106
<b>Lounge Twin Pedestal Base - 575mm High</b>						
LTF5127L	Rectangular	1200 x 700	£985	£1,199	£1,360	£1,442
LTF5147L	Rectangular	1400 x 700	£1,014	£1,226	£1,389	£1,469
LTF5128L	Rectangular	1200 x 800	£995	£1,209	£1,369	£1,452
LTF5148L	Rectangular	1400 x 800	£1,023	£1,235	£1,394	£1,479
<b>Dining - 745mm High</b>						
LTF506CD	Circular	Ø600	£625	£835	£996	£1,081
LTF507CD	Circular	Ø700	£641	£856	£1,014	£1,098
LTF508CD	Circular	Ø800	£664	£875	£1,037	£1,117
LTF566D	Square	600 x 600	£612	£827	£985	£1,069
LTF577D	Square	700 x 700	£634	£845	£1,007	£1,088
LTF588D	Square	800 x 800	£652	£864	£1,024	£1,106
<b>Dining Twin Pedestal Base - 745mm High</b>						
LTF5127D	Rectangular	1200 x 700	£985	£1,199	£1,360	£1,442
LTF5147D	Rectangular	1400 x 700	£1,014	£1,226	£1,389	£1,469
LTF5128D	Rectangular	1200 x 800	£995	£1,209	£1,369	£1,452
LTF5148D	Rectangular	1400 x 800	£1,023	£1,235	£1,394	£1,479
<b>Mid Poseur - 905mm High</b>						
LTF506CMP	Circular	Ø600	£719	£930	£1,088	£1,171
LTF566MP	Square	600 x 600	£697	£909	£1,070	£1,152
<b>Poseur - 1105mm High</b>						
LTF506CP	Circular	Ø600	£719	£930	£1,088	£1,171
LTF566P	Square	600 x 600	£697	£909	£1,070	£1,152
<b>Twin Pedestal Poseur - 1105mm High</b>						
LTF5127P	Rectangular	1200 x 700	£1,060	£1,274	£1,433	£1,516
LTF5147P	Rectangular	1400 x 700	£1,087	£1,300	£1,460	£1,543
LTF5128P	Rectangular	1200 x 800	£1,070	£1,282	£1,443	£1,524
LTF5148P	Rectangular	1400 x 800	£1,100	£1,310	£1,472	£1,554

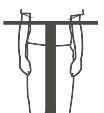
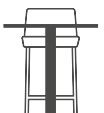
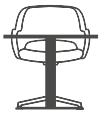

# LTF STEEL TABLES

10 Year  
Guarantee

Tables



# RECEPTION TABLES

10 Year  
Guarantee

Code	Description	W	D	H	Group Z 25mm MFC	Group B 36mm MFC	Group C 25mm Lam Kiko	Group D 25mm CH Lam Kiko
<b>Gallen Reception Tables</b> Foot colours available in Natural Wood, Dark Walnut and Black Wood.								
GAL106	Soft Rectangular	1000	x 600	x 435	£570	£773	£927	£1,007
GAL088	Soft Square	800	x 800	x 435	£570	£773	£927	£1,007
GAL066	Soft Square	600	x 600	x 435	£513	£721	£874	£953
GALC08	Circular	Ø800	x	435	£622	£828	£980	£1,063
GALC06	Circular	Ø600	x	435	£565	£771	£925	£1,005



## Alvier Wooden Leg Reception Table

Wooden leg available in Natural Wood and Dark Walnut.

NST069W	Soft Rectangular	980	x 680	x 275	£570	£773	£927	£1,007
---------	------------------	-----	-------	-------	------	------	------	--------



## Alvier Sled Leg Reception Table

Metalwork available in Black, Grey, Silver or White.  
Surcharge for Pastel Paint - £33 per item.

NST069S	Soft Rectangular	980	x 680	x 275	£570	£773	£927	£1,007
---------	------------------	-----	-------	-------	------	------	------	--------



## Adore Reception Table with Rod Frame

Metalwork available in Black, Grey, Silver or White.  
Surcharge for Pastel Paint - £33 per item.

AD66	Soft Square	600	x 600	x 275	£428	£636	£788	£866
AD06	Circular	Ø600	x	450	£428	£636	£788	£866
AD6645	Soft Square	600	x 600	x 450	£428	£636	£788	£866



Gallen



Alvier Wooden Leg



Alvier Sled Leg



Adore



Code	Description	W	D	Price
------	-------------	---	---	-------

## EX10 Panel End Reception Tables - 400mm High 25mm MFC

KNPTRR10	Rectangular	100	x 600	£363
KNPTRR6	Square	600	x 600	£285
KNDPTRL	Lozenge	1000	x 600	£427
KNPTRC8	Circular	ø800		£441
KNPTRC	Circular	ø600		£315



Code	Description	Price
HAT	Hat & coat stand	£82
HATU	Hat & Coat stand with umbrella ring	£107





10 Year  
Guarantee

# RECEPTION TABLES

Tables



Adore Circular Reception Table

# VONA TABLES

10 Year  
Guarantee

Vona table was developed to complement the Vona chair. With its sleek rod frame design and 100% recyclability, it's the perfect match.

- Available with circular and square top panels.
- 25mm MFC top panels
- Optional central port hole (suit power modules)



When specifying Cable Ports -  
suffix the table code with code P

Tables

Code	Description	Dimensions	MFC Price
<b>Vona Table</b>			
LS3410CD	Circular	1000ø x 727H	£334
LS341010S	Square	1000 x 1000 x 727H	£356



LS3410CD

10 Year  
Guarantee

# GD3 TABLES

GD3 Table was developed to complement the GD3 Stools. With its sleek rod frame design and 100% recyclability, it's the perfect match.

- Available with circular and square top panels.
- 25mm MFC top panels
- Optional central port hole (suit power modules)



When specifying Cable Ports -  
suffix the table code with code P

Code	Description	Dimensions	MFC Price
<b>GD3 Table</b>			
GD3T10CD	Circular	1000ø x 727H	£319
GD3T1010S	Square	1000 x 1000 x 727H	£339



Tables



GD3T10CD

# GD27 TABLES



An industrial inspired table with a square steel tube frame.

Available in two footprints and two heights to use as a contemporary sofa end table or sleek coffee table in any living or commercial space.



Tables

Code	Description	W	L	H	18mm MFC	
<b>Side Table</b>						
GD27A1	Square Single Table	450	x 450	x 455	£568	
GD27B1	Square Single Table	450	x 450	x 575	£568	
GD27A2	Rectangular Single Table	450	x 915	x 455	£990	
GD27B2	Rectangular Single Table	450	x 915	x 575	£990	
GD27A3	Rectangular Twin Table	450	x 885	x 455	£990	
GD27B3	Rectangular Twin Table	450	x 885	x 575	£990	



Square Single Table



Rectangular Single Table



Rectangular Twin Table



GD27 Side Table MFC

Included are a selection of multi-purpose products that can be used in every-day applications.

Items are available in a variety of finishes allowing them to be used individually or suited with other products.



Code	Description	W	D	Price
------	-------------	---	---	-------

**Laptop Table 18mm Lacquered MDF Top Panel**  
Metalwork only available in Black, White or Silver  
Top Panels available in Black or White

LAPHAM	625/1050h height adjustable	520 x 380	£529
--------	--------------------------------	-----------	------



**Laptop Tables 25mm MFC Top Panels**  
Metalwork only available in Black, White or Silver

LAPHA	625/1050h height adjustable	400 x 350	£497
LAPST	650h fixed height	400 x 350	£434



Code	Description	W	D	MFC Price
------	-------------	---	---	-----------

**Telephone / Fax Tables**

FT80Z	800 x 450	£227
FT60Z	600 x 450	£188



**Exam Table**

ET86Z	Top Dimensions 765 x 504	£158
	Overall Dimensions 860 x 504	

Code	Description	W	D	MFC Price
------	-------------	---	---	-----------

**Folding Exam Table**

ETF86Z	860 x 500	£195
--------	-----------	------



**Folding Exam Table Trolley**

ETFT	To suit 25x folding exam tables	1650 x 930	£578
------	---------------------------------	------------	------



Code	Description	W	D	H	Price
------	-------------	---	---	---	-------

**Glass Clear Top**  
Conical legs available in Black or Chrome.

GLAS9S	Rectangular	950 x 500 x 350	£381
GLAS5S	Square	500 x 500 x 350	£297

**Glass Frosted Top**  
Conical legs available in Black or Chrome.

GLAS9F	Rectangular	950 x 500 x 350	£489
GLAS5F	Square	500 x 500 x 350	£339
GLAS6F	Circular	Ø500 x 350	£508



GLASS Reception Table

# RELO TABLES



A continuation of calm: Gresham introduces its new Relo table range. Crafted to seamlessly complement Gresham's Relo collection of rounded chairs, the new Relo table range supports designers in creating comforting, calming schemes. Mirroring the unmistakable curves of Relo, the tables offer a visual link back to their aesthetic inspiration; that of sea-smoothed pebbles and stones emerging from turbulent waters. Available in 9 variations, versatility is offered as standard. From larger, two-tiered designs to smaller options, there's a combination to suit all contemporary spaces. The circular tabletop is created from MFC (Melamine Faced Chipboard), and the statement 20mm geometric steel frames can be chosen in Black, White, Grey or Silver.

Available Frame Colours

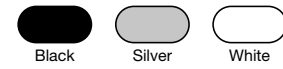

Tables



**RELTA1**  
Small Low Circular Table



**RELTA2**  
Small High Circular Table



**RELTB1**  
Large Circular Table



**RELTB2**  
Large Circular Table with Shelf





# RELO TABLES

Code	Description	Width	Depth	Height	MFC
RELTA1	Small Low Circular Table	Ø495	x	455	£242
RELTA2	Small High Circular Table	Ø495	x	575	£249
RELTB1	Large Circular Table	Ø740	x	455	£288
RELTB2	Large Circular Table with Shelf	Ø740	x	455	£342
RELTC1	Low Cylindrical Table	1240	x 500	x 455	£369
RELTC2	High Cylindrical Table	1240	x 500	x 575	£376
RELTC3	High Cylindrical Table with Shelf	1240	x 500	x 575	£440
RELTD1	Low Cylindrical Table with Circular Shelf	1240	x 500	x 455/570	£505
RELTD2	High Cylindrical Table with Circular Shelf	1240	x 500	x 575/690	£510



**RELTC1**  
Low Cylindrical Table



**RELTC2**  
High Cylindrical Table



**RELTC3**  
High Cylindrical Table with Shelf



**RELTD1**  
Low Cylindrical Table with Circular Shelf



**RELTD2**  
High Cylindrical Table with Circular Shelf



# INTRODUCTION

## SCREENS & PODS

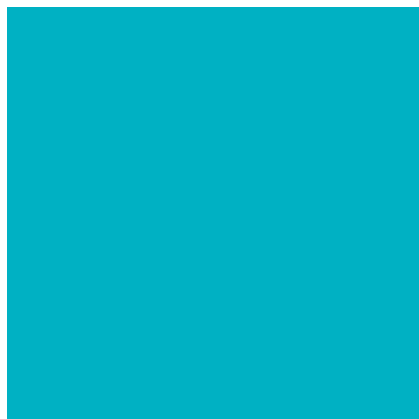
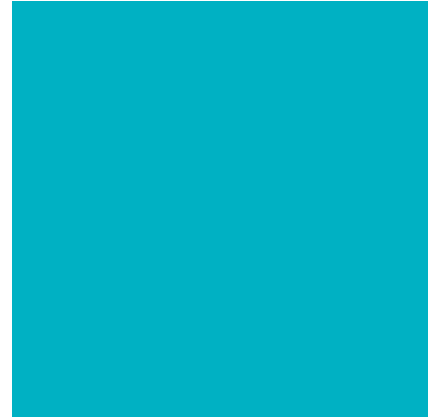
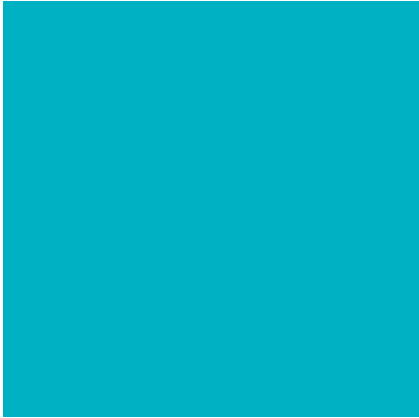
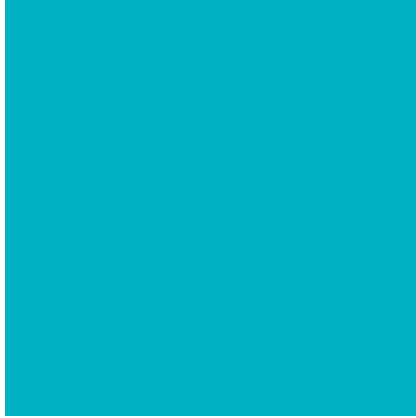



# INTRODUCTION SCREENS & PODS



For board finishes please see Technical Information section.



For GOF Screen fabrics please see Technical Information section (Guarantees shown exclude upholstery).



For GOF Screen Acrylics please see Technical Information section.



GOF Screen accessories available.

## GOF SCREEN COLOURED FROSTED ACRYLICS (SURCHARGE)

				
S2 9T21 Stone Grey	S2 4T50 Chilli Red	S2 2T07 Citrus Yellow	S2 7T28 Sapphire Blue	S2 3T17 Mandarin Orange
				
S2 6T21 Glacier Green	S2 7T77 Arctic Blue	S2 4T46 Blush Pink	S2 7T58 Aurora Violet	S2 6T9A Lime Zest
				
S2 7T1F Azure Blue	S2 7T69 Electric Blue	S2 9221 Midnight Black		

## GOF & MESA PLUS SCREEN FABRICS

<b>Band 1</b> Camira Cara Camira Carlow Camira Lucia Camira Sonus Inloom Bondai 170	<b>Band 2</b> Camira Lucia CS	<b>Band 3</b> Camira Blazer Lite Camira Nexus
--	----------------------------------	---

## GOF SCREEN ACRYLICS

PERSPEX  



S2 000  
Clear

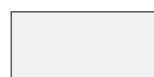

S2 030  
Polar Frost

# KULTURE HABITAT SCREENS & PODS



Thoroughly fit for the contemporary workplace, our Kulture Habitat Pods respond directly to the needs of both employees and employers. Providing an adaptable space that can facilitate quiet 'heads down' tasks, small-scale collaboration, or group meetings, this is a beautifully efficient solution that can be made to fit all. Personalise your Pod by choosing from a range of bespoke options, from single or half glazed and upholstered walls, to a canopy fitted with stylish, sound absorbent PET panels, and a booth with integrated table - there's a combination to suit every scheme.

Please Note: The Canopy and Booth are not available as standalone products. They must be used in conjunction with Kulture Habitat Glazed Pods.

## Product Features



## Available Frame Colours

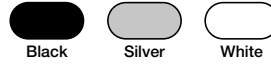

Please Note: Prices do not include installation which is mandatory by Gresham qualified installers. Installation costs will be an additional charge and will be supplied on completion of a Gresham consultation or site survey form.

Screens & Pods

## Kulture Habitat Fabric Options

Fabric Band A	EN 1021 / BS 476 P7 -	100% Polypropylene	x
Camira Cara	C&M -	100% Polypropylene	x
Camira Carlow	C&M 30,000	100% FR Polypropylene	
Camira Citadel	C&M 80,000	76% Polyester, 24% Recycled Polyester	
Camira Gravity	C&M 80000	100% Recycled Polyester	
Camira Rivet	C&M 70,000	100% Polyester	
Inloom Erika			
Fabric Band B			
Camira Aspect	CRIB 5 50,000	75% Trevira CS FR Polyester, 25% Polyester	
Camira Blazer	C&M 50,000	100% Virgin Wool	
Camira Blazer Lite	BS 476 -	100% Virgin Wool	x
Camira Patina	CRIB 5 100,000	69% Wool, 22% Flax, 8% Polyamide, 1% Viscose	
Camira Synergy 170	C&M 100,000	95% Virgin Wool, 5% Polyamide	x
Camira Synergy	C&M 100,000	95% Virgin Wool, 5% Polyamide	
Camira X2	CRIB 5 100,000	100% Recycled FR Polyester	
Inloom One	C&M 100,000	100% Recycled FR Polyester	
Inloom Jet Bioactive	CRIB 5	100% Polyester	
Inloom Roccia	CRIB5	100% Polyester	
Agua Buro	CRIB 5	100% Treated Polyester	

x - Denotes seating is not available in this fabric





# KULTURE HABITAT SCREENS & PODS



Screens & Pods

## Kulture Habitat PET Colour Options



## Single Glazed Pods

Strong in both form and function, our Single Glazed Habitat Pod comprises a seamless meeting room solution - offering a quiet corner away from the hustle and bustle of the main workspace for calls, chats, and head's down work.

### Standard Features

- Acoustically tested to BSEN ISO 140 and rated at 36dB noise reduction.
- 55mm sound absorbing upholstered panels.
- 22mm double glazed glass panels with stripe manifestations.
- 8mm glass door with stripe manifestations.
- 52mm sound absorbing ceiling panels upholstered in light grey.
- Integrated ceiling cover included as standard.
- Integrated facilities arch included as standard housing lighting system.
- PIR operated, high output - low voltage, diffused dual LED strip lighting included as standard.

### Options

- Air circulation fan available with 216m<sup>3</sup>/h airflow.
- Flush mounted modules available with power, charge, data, HDMI & VGA
- Alternative widths and depths available on request.
- Alternative panel finishes available on request.



**KHP2020WG**  
2 Person Pod  
2000w x 2000d



**KHP2520WG**  
2 Person Pod  
2500w x 2000d



**KHP3020WG**  
3 Person Pod  
3000w x 2000d



**KHP3520WG**  
3 Person Pod  
3500w x 2000d



**KHP2024WG**  
2 Person Pod  
2000w x 2400d



**KHP2524WG**  
2 Person Pod  
2500w x 2400d



**KHP3024WG**  
3 Person Pod  
3000w x 2400d



**KHP3524WG**  
3 Person Pod  
3500w x 2400d

## Single Glazed Pods

Model	Dimensions (mm)	Height (mm)	Suitable for	Suitable Table	Band A	Band B
KHP2020WG	2000w x 2000d	2200	2 People	800mm Dia.	£21,086	£23,354
KHP2520WG	2500w x 2000d	2200	2 People	800mm Dia.	£22,874	£25,181
KHP3020WG	3000w x 2000d	2200	3 People	800mm Dia.	£24,748	£27,394
KHP3520WG	3500w x 2000d	2200	3 People	800mm Dia.	£26,409	£29,078
KHP2024WG	2000w x 2400d	2200	2 People	800mm Dia.	£21,541	£23,809
KHP2524WG	2500w x 2400d	2200	2 People	800mm Dia.	£23,394	£25,701
KHP3024WG	3000w x 2400d	2200	3 People	800mm Dia.	£25,285	£27,930
KHP3524WG	3500w x 2400d	2200	3 People	800mm Dia.	£27,356	£30,032



## Half Glazed Pods

Extending the design possibilities of our Habitat Pods is the Half Glazed range, which allows natural light to flow into the space from both sides. When incorporated into a workplace scheme, it efficiently, and beautifully, promotes privacy.

### Optional Extras

Air circulation fan .....	£1,679
Flush 1x UK Power Socket .....	£777
Flush 2x UK Power Sockets .....	£827
Flush 1x TUF Socket (1x USB & 1x USB-C) .....	£1,095
TV/Monitor Mount Bracket (32"-50") .....	£1,174
Sliding Door Lock .....	£1,798
Slow Door Close System .....	£542
Dimmable Remote Control .....	£877



Screens & Pods



**KHP2020HG**  
2 Person Pod  
2000w x 2000d



**KHP2520HG**  
2 Person Pod  
2500w x 2000d



**KHP3020HG**  
3 Person Pod  
3000w x 2000d



**KHP3520HG**  
3 Person Pod  
3500w x 2000d



**KHP2024HG**  
2 Person Pod  
2000w x 2400d



**KHP2524HG**  
2 Person Pod  
2500w x 2400d



**KHP3024HG**  
3 Person Pod  
3000w x 2400d



**KHP3524HG**  
3 Person Pod  
3500w x 2400d

## Half Glazed Pods

Model	Dimensions (mm)	Height (mm)	Suitable for	Suitable Table	Band A	Band B
KHP2020HG	2000w x 2000d	2200	2 People	800mm Dia.	£21,909	£23,427
KHP2520HG	2500w x 2000d	2200	2 People	800mm Dia.	£24,340	£25,896
KHP3020HG	3000w x 2000d	2200	3 People	800mm Dia.	£26,081	£27,593
KHP3520HG	3500w x 2000d	2200	3 People	800mm Dia.	£27,240	£29,512
KHP2024HG	2000w x 2400d	2200	2 People	800mm Dia.	£22,367	£23,837
KHP2524HG	2500w x 2400d	2200	2 People	800mm Dia.	£24,860	£26,416
KHP3024HG	3000w x 2400d	2200	3 People	800mm Dia.	£26,495	£28,013
KHP3524HG	3500w x 2400d	2200	3 People	800mm Dia.	£29,294	£30,832

# KULTURE HABITAT SCREENS & PODS

NEW  
PRODUCT

5 Year  
Guarantee

## Canopy Pods

Limited space doesn't have to mean compromise. Our Canopy range allows a portion of the office to be separated for collaborative work, facilitating privacy and minimising disturbance to those situated close-by.

### Standard Features

- Add-On Open Canopy with stylish PET panels, a material manufactured from recycled sources and has a great environmental story.
- PET is naturally sound absorbing so whilst refreshing an office environment you can help reduce reverberation at the same time.
- 12mm thick PET acoustically tested to ASTM C423-17 with NRC 0.80
- PET panels available in a variety of colours.



Screens & Pods



**KHC1820**  
4 Person Pod  
1800w x 2000d



**KHC2320**  
4 Person Pod  
2300w x 2000d



**KHC1824**  
4 Person Pod  
1800w x 2400d



**KHC2324**  
4 Person Pod  
2300w x 2400d

## Canopy Pods

Model	Dimensions (mm)	Height (mm)	Suitable for	Suitable Table	Price
KHC1820	1800w x 2000d	2200	4 People	1200mm x 800mm	£8,339
KHC2320	2300w x 2000d	2200	4 People	1400mm x 800mm	£8,494
KHC1824	1800w x 2400d	2200	4 People	1200mm x 800mm	£8,447
KHC2324	2300w x 2400d	2200	4 People	1400mm x 800mm	£8,603



## Booth Pods

Providing an informal space for collaboration, our Booths, with integrated seating and table, offer a comfortable, semi-enclosed area for one-on-one discussions, small group meetings and the completion of solo tasks.

### Standard Features

- Add-On seating booth with integrated table.
- Table at 727mm high with single post support leg.
- Post mounted brushed steel task light included.

### Optional Extras

Flush 1x UK Power Socket .....	£777
Flush 2x UK Power Sockets.....	£827
Flush 1x TUF Socket (1x USB & 1x USB-C) .....	£1,095
TV/Monitor Mount Bracket (32"-50") .....	£1,174



Screens & Pods



**KHB0820**  
2 Person Pod  
800w x 2000d



**KHB1220**  
4 Person Pod  
1200w x 2000d



**KHB1620**  
4-6 Person Pod  
1600w x 2000d



**KHB0824**  
2 Person Pod  
800w x 2400d



**KHB1224**  
4 Person Pod  
1200w x 2400d



**KHB1624**  
4-6 Person Pod  
1600w x 2400d

## Booth Pods

Model	Dimensions (mm)	Height (mm)	Suitable for	Supplied Table	Band A	Band B
KHB0820	800w x 2000d	2200	2 People	800mm x 750mm	£8,760	£10,382
KHB1220	1200w x 2000d	2200	4 People	1200mm x 750mm	£10,693	£12,310
KHB1620	1600w x 2000d	2200	4-6 People	1600mm x 750mm	£15,005	£16,936
KHB0824	800w x 2400d	2200	2 People	800mm x 1000mm	£8,805	£10,336
KHB1224	1200w x 2400d	2200	4 People	1200mm x 1000mm	£10,791	£12,217
KHB1624	1600w x 2400d	2200	4-6 People	1600mm x 1000mm	£15,084	£16,858

# MIRAGE HUTCH SCREENS & PODS



Designed in response to the needs of the contemporary workplace, our Mirage Hutch range not only offers functionality, but comprises a stylish office focal point, too. Available as either a two, four or six-seater pod, with a flat or pitched roof, this unique product can be customised to suit any space, and all interior styles. Choose to upholster your pod in one single shade of fabric, or pair two complementary or contrasting tones to create all-out statement.

## Product Features



### Available Frame Colours

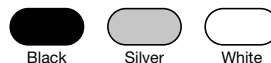

### Available Wood Finishes



Screens & Pods



**MCON02PS**  
2 Person Pod  
Pitched Roof & LED Spotlight



**MCON02PP**  
2 Person Pod  
Pitched Roof & Pendant Light



**MCON04PS**  
4 Person Pod  
Pitched Roof & LED Spotlight



**MCON04PP**  
4 Person Pod  
Pitched Roof & Pendant Light



**MCON06PS**  
6 Person Pod  
Pitched Roof & LED Spotlight



**MCON06PP**  
6 Person Pod  
Pitched Roof & Pendant Light



**MCON01FS**  
1 Person Pod  
Flat Roof & LED Spotlight



**MCON02FS**  
2 Person Pod  
Flat Roof & LED Spotlight



**MCON02FP**  
2 Person Pod  
Flat Roof & Pendant Light



**MCON04FS**  
4 Person Pod  
Flat Roof & LED Spotlight



**MCON04FP**  
4 Person Pod  
Flat Roof & Pendant Light



**MCON06FS**  
6 Person Pod  
Flat Roof & LED Spotlight



**MCON06FP**  
6 Person Pod  
Flat Roof & Pendant Light

Model	Roof Style	Dimensions (mm)	Height (mm)	Suitable for	Lighting	Band A	Band B
MCON02PS	Pitched Roof	2000w x 800d	2100	2 People	LED Spotlight	£16,936	£18,467
MCON02PP	Pitched Roof	2000w x 800d	2100	2 People	Pendant Light	£16,936	£18,467
MCON04PS	Pitched Roof	2000w x 1200d	2100	4 People	LED Spotlight	£20,439	£22,048
MCON04PP	Pitched Roof	2000w x 1200d	2100	4 People	Pendant Light	£20,439	£22,048
MCON06PS	Pitched Roof	2000w x 1900d	2100	6 People	LED Spotlight	£24,550	£26,081
MCON06PP	Pitched Roof	2000w x 1900d	2100	6 People	Pendant Light	£24,550	£26,081
MCON01FS	Flat Roof	1100w x 800d	2100	1 People	LED Spotlight	£13,240	£14,185
MCON02FS	Flat Roof	2000w x 800d	2100	2 People	LED Spotlight	£16,936	£18,467
MCON02FP	Flat Roof	2000w x 800d	2100	2 People	Pendant Light	£16,936	£18,467
MCON04FS	Flat Roof	2000w x 1200d	2100	4 People	LED Spotlight	£20,439	£22,048
MCON04FP	Flat Roof	2000w x 1200d	2100	4 People	Pendant Light	£20,439	£22,048
MCON06FS	Flat Roof	2000w x 1900d	2100	6 People	LED Spotlight	£24,550	£26,081
MCON06FP	Flat Roof	2000w x 1900d	2100	6 People	Pendant Light	£24,550	£26,081





# MIRAGE HUTCH SCREENS & PODS

## Mirage Hutch Fabric Options

Fabric Band A				
Camira Carlow	C&M	-	100% Polypropylene	x
Camira Citadel	C&M	30,000	100% FR Polypropylene	
Camira Gravity	C&M	80,000	76% Polyester, 24% Recycled Polyester	
Camira Rivet	C&M	80000	100% Recycled Polyester	
Fabric Band B				
Camira Aspect	CRIB 5	50,000	75% Trevira CS FR Polyester, 25% Polyester	
Camira Blazer	C&M	50,000	100% Virgin Wool	
Camira Blazer Lite	BS 476	-	100% Virgin Wool	x
Camira Oceanic	BS 7176	100,000	100% Recycled Polyester including 50% SEAQUAL yarn	
Camira Patina	CRIB 5	100,000	69% Wool, 22% Flax, 8% Polyamide, 1% Viscose	
Camira Synergy 170	C&M	100,000	95% Virgin Wool, 5% Polyamide	x
Camira Synergy	C&M	100,000	95% Virgin Wool, 5% Polyamide	
Camira X2	CRIB 5	100,000	100% Recycled FR Polyester	
Inloom Jet Bioactive	CRIB 5		100% Polyester	
Inloom Roccia	CRIB5		100% Polyester	
Agua Buro	CRIB 5		100% Treated Polyester	

x - Denotes seating is not available in this fabric



Oak Wood - Seats: Camira Synergy Intertwine LDS42 / Walls: Camira Synergy Summon LDS45 (Shown without Vertical Channel - POA)

## MIRAGE PODS & GE MOBILE

Mirage Pod & GE Mobile fabrics differ from our standard fabric bands. Fabrics for these products have a laminated foam backing that increases sound absorbency. A number of fabric selections for Mirage Pods and GE Mobile are available as shown.

Mirage Pods & GE Mobile can have different tiered levels in alternative fabrics as illustrated below. If all the chosen fabrics are all from the same selection, then please choose the relevant fabric selection price. If the chosen fabrics are a mixture of selections, then choose the highest relevant fabric selection price.

Other fabrics may be available on request - POA. Fabrics not shown in Selections 1-4 may be subject to testing.

Screens & Pods

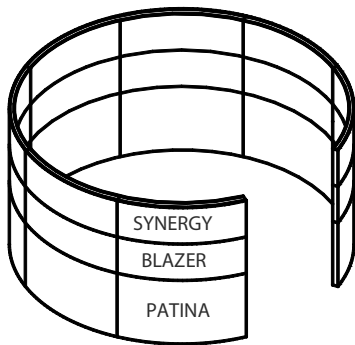

Example:  
Fabrics from same selection  
(Fabric Selection 4 Price)

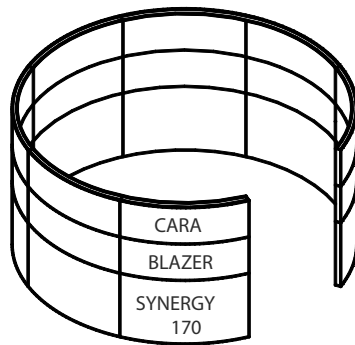

Example:  
Mixture of fabrics from different selections  
(Fabric Selection 3 Price - Highest)

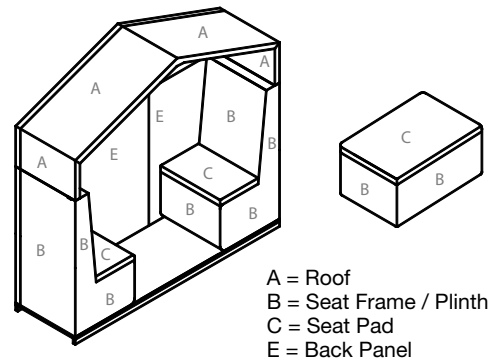

A = Roof  
B = Seat Frame / Plinth  
C = Seat Pad  
E = Back Panel

## MIRAGE LITE/TACKABLE & GE6

Due to manufacturing processes Mirage Lite & GE6 fabric options differ from our standard screen fabric bands and the available fabrics are shown in their relevant section of the Product Guide. Prices shown are for single colour fabrics only. Tackable versions of Mirage Lite are available for a £91 surcharge.

Other fabrics may be available on request - POA. Mirage Lite Acoustic desk top screens are also available on request – POA.

5 Year  
Guarantee

# MIRAGE PODS SCREENS & PODS

Screens & Pods



Mirage Colorado Semi Circular Pod

## MIRAGE PODS

Workspace design has evolved over the decades to meet the changing demands of the workplace and the needs of the people who work in them.

Today, the very best contemporary workspaces are designed to provide not only functional efficiency, but be responsive to the needs of employees in terms of enhancing productivity and promoting personal wellbeing. Smart lateral thinking is required to create a multi-purpose environment that successfully achieves these goals, all within one singular space.

Able to transform a chaotic open plan spaces into an oasis of calm, where zones designed for privacy, for collaborative work, and for core activities function together seamlessly, the Mirage family of pods are the product of such thinking.

Mirage uses high quality materials to create aesthetically pleasing modular pods for employees to work in. Their carefully crafted panels and coloured trim reflects the purpose of each pod and how it will be used. Subtle, tranquil hues enhance quiet contemplation, for example, while bright, vibrant shades help to create a stimulating workspace that facilitates increased creativity and productivity.

As well as helping you to reorganise your office in order to make best use of existing floorspace, Mirage Pods also help to provide noise control for energetic working environments. Slimline panels can reduce noise levels by up to 30 decibels, meaning that private spaces remain private, while the acoustics in shared spaces promote great communication.



5 Year  
Guarantee

## MIRAGE PODS SCREENS & PODS



# MIRAGE PODS

## SCREENS & PODS

5 Year  
Guarantee

### GOBI STUDY POD

Single occupancy Gobi pods provide quiet work areas that allow users to focus on specific tasks in an environment that minimises distractions caused by external noise. These pods are cosy, ergonomically designed, and perfectly suited for their purpose. You have the option of selecting modules equipped for either permanently based equipment or mobile devices, or both, depending on your requirements. The most popular Gobi pods are of a two-tier height that works to create a protective cocoon around seated users. When standing, users are able to get a clear view of surrounding open plan areas. Gobi individual pods have a relatively small footprint, making them easy to place, and are also available in a slightly taller version, shaped like a phone booth, which has a roof plus perch points for users. These taller pods also have a useful integral light that is activated as the user approaches the booth.



## SONORAN WORK POD

Sonoran pods are designed to provide private, separate workspaces that can be clustered together in different configurations. They are ideal for housing team members or workers who benefit from being geographically close together but who still want to occupy an individual unit.

The integral work surfaces are generally straight rather than curved, giving the pods a streamlined appearance. You also have the option of adding service modules and cabling as required for permanently installed equipment, as well as for mobile devices. Configuring your Sonoran pods couldn't be easier. Select single-sided pods allow users to share walls or opt for a back-to-back layout if preferred. When clustered, these pods make the most of existing floor space, allowing you to provide workspace for a greater number of people per square metre.

Sonoran pods are extremely efficient and cost effective, requiring few components.



# MIRAGE PODS SCREENS & PODS

5 Year  
Guarantee

## ATACAMA STUDY POD

If your workplace requires pod clusters that can function like hot desk stations, Atacama pods with shared components provide an ideal solution. Each pod has a triangular shape, which allows for the creation of a zigzag footprint when clustered with other Atacama pods, with each user being placed in the resultant zigzag corner. Work surfaces are designed to allow cabling to pass neatly through a cut-out space, and configured so that its possible to mount flat screen monitors or place desk top service modules within easy reach of occupants. With smaller work surfaces than Sonoran pods, people are less likely to clutter up the tapered space with personal effects. Atacama is the ideal pod for workers who need everything to hand when they drop in for a short period of time before moving on. This is a highly efficient solution that maximises available space for a mobile workforce.



Screens & Pods





## SAHARA MEETING POD

Shared workspaces need to be carefully structured to make the most of the available space, as well as enhance the type of activity taking place within them. Sahara pods are designed to create a multiple occupancy workspace that facilitates collaborative work in a quiet environment. Thanks to its acoustic dampening function, whether you want to create a quiet collaborative working space, free from distractions within an open plan area, or a room in which lively discussion can be contained, Sahara pods can do both. The flexibility of the Sahara system means you can choose from a range of larger pods with options for the number of tiers required. Single tiers can be used to delineate space, while units with additional tiers allow for increased privacy. To create shared service areas for printers and photocopiers, simply use Sahara to encircle equipment and deaden the sound.



# MIRAGE PODS

## SCREENS & PODS



### COLORADO MEETING POD

Colorado pods have gently curved walls, and are therefore ideal for creating layouts that are less angular and more fluid by design. Use of such aesthetics softens interior spaces, making them perfect environments for use as informal break-out areas, or as comfortable rooms in which to hold formal meetings and conference activities. As with Sahara pods, additional tiers can be added to Colorado units for privacy purposes, and there is also the option to choose whether you'd like the pod to have one or two entry points. This might depend, for example, on the level of access you need, as well as on what type of activities you plan for the pod. Furniture options include soft seating, suitable for informal activities, and dining or meeting and conference furniture for more formal events. You can structure Colorado pods exactly as you wish for specific activities, such as staff training sessions or briefings.



Screens & Pods



## KARAKUM MEETING POD

The Karakum range offers the perfect solution for housing small, private groups. The pod walls are three tiers high, above which can be found an integral roof. Pods suitable for occupancy by two, four or six occupants are available, in-line with your needs, as are units that include efficient LED lighting. Sensors for the lighting are triggered when Karakum is occupied, and will switch off when the pods are empty, ensuring optimal energy efficiency. Despite having a roof,

the Karakum pod is designed to promote clean air circulation, helping users to stay focused and motivated. Selecting furniture from the options available will allow you to determine how the pod is to be used. Services can be routed from the floor upwards via the walls, as is the case with all Mirage pods, to feed adjacent or fixed work surfaces as well as suspended equipment such as monitors and projectors.



# MIRAGE PODS SCREENS & PODS



Screens & Pods

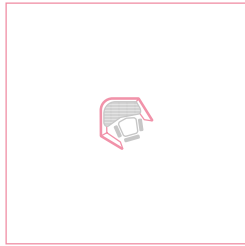

**MP20R-12**  
Single User Right Hand  
Study Pod

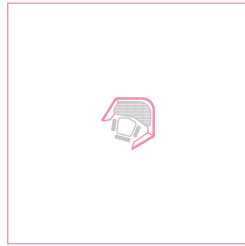

**MP20L-12**  
Single User Left Hand  
Study Pod

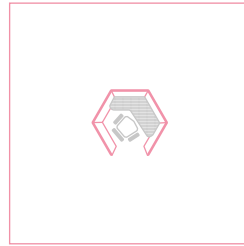

**MP21R-18**  
Single User Right Hand  
Study Pod

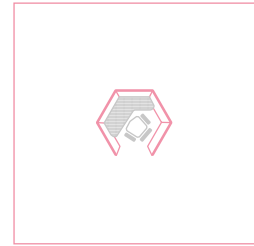

**MP21L-18**  
Single User Left Hand  
Study Pod

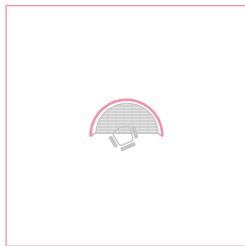

**MP23-17**  
Single User  
Study Pod

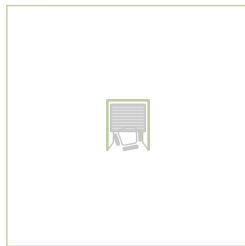

**MP1-10**  
Small Single User  
Work Pod

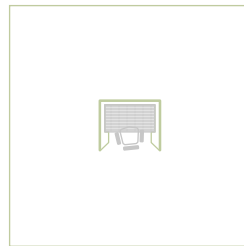

**MP1-14**  
Large Single User  
Work Pod

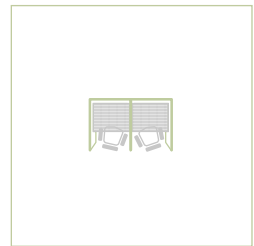

**MP3-10**  
Small 2 User  
Work Pod

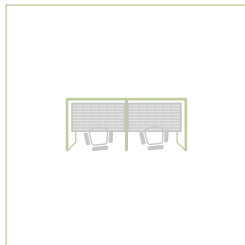

**MP3-14**  
Large 2 User  
Work Pod

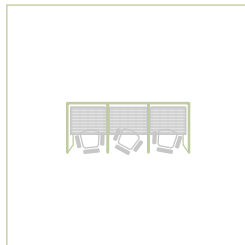

**MP5-10**  
Small 3 User  
Work Pod

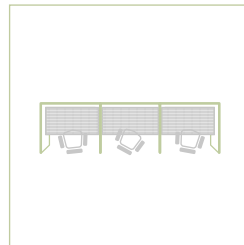

**MP5-14**  
Large 3 User  
Work Pod

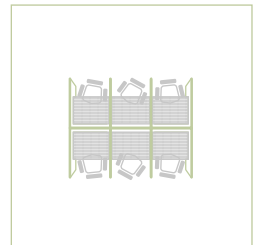

**MP6-10**  
Small 6 Facing User  
Work Pod

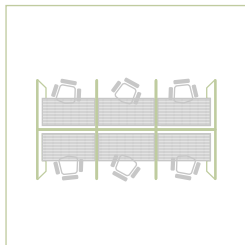

**MP6-14**  
Large 6 Facing User  
Work Pod

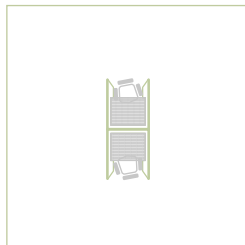

**MP2-10**  
Small 2 Facing User  
Work Pod

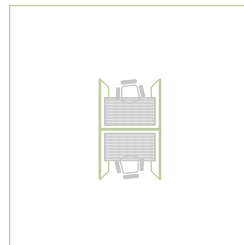

**MP2-14**  
Large 2 Facing User  
Work Pod

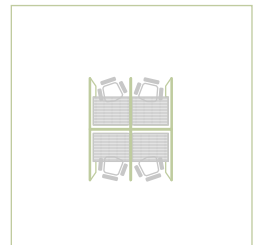

**MP4-10**  
Small 4 Facing User  
Work Pod

**Key:**

- Gobi
- Sahara
- Sonoran
- Colorado
- Atacama
- Karakum

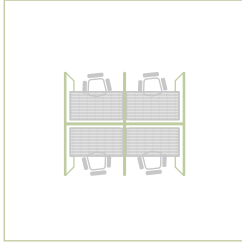

**MP4-14**  
Large 4 Facing User  
Work Pod

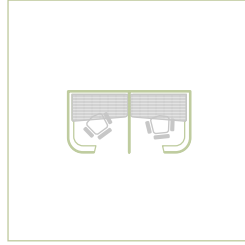

**MP14-29**  
2 User  
Work Pod

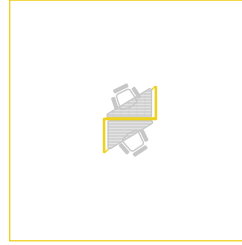

**MP7L-12**  
2 User Left Hand  
Zig Zag Study Pod

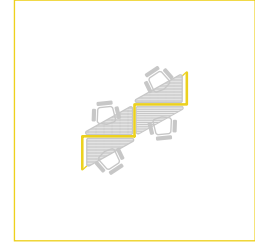

**MP7L-23**  
4 User Left Hand  
Zig Zag Study Pod

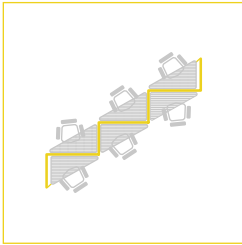

**MP7L-32**  
6 User Left Hand  
Zig Zag Study Pod

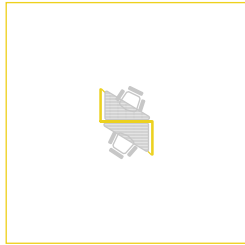

**MP7R-12**  
2 User Right Hand  
Zig Zag Study Pod

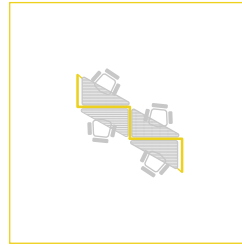

**MP7R-23**  
4 User Right Hand  
Zig Zag Study Pod

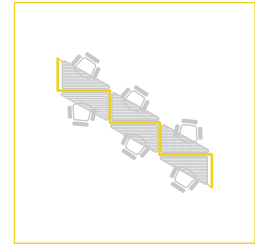

**MP7R-32**  
6 User Right Hand  
Zig Zag Study Pod

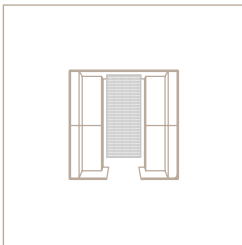

**MP11-25**  
Single Entry Square  
Meeting Pod  
  
Fits: 4x LS24B1 2 Seater Sofas  
and up to 2000w x 800d Dining  
Height Table (Not Supplied)

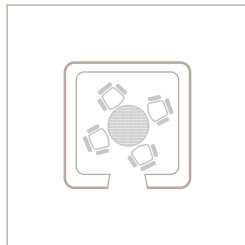

**MP10-30**  
Single Entry Square  
Meeting Pod  
  
Fits: 1000Ø Table and 4 Chairs  
(Not Supplied)

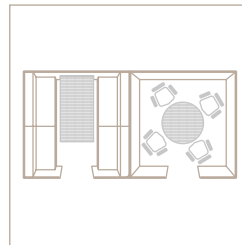

**MP12-50**  
Twin Entry Rectangular  
Meeting Pod  
  
Fits: 4x LS24B1 2 Seater Sofas  
and up to 2000w x 800d Dining  
Height Table and 1000Ø Table  
and 4 Chairs (Not Supplied)

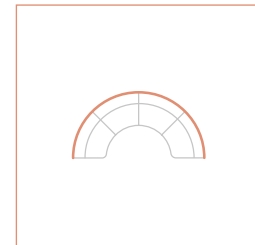

**MP28-30**  
Semi-Circular  
Meeting Pod  
  
Fits: 4x LS24D1 Small Curved  
Seater Sofas (Not Supplied)

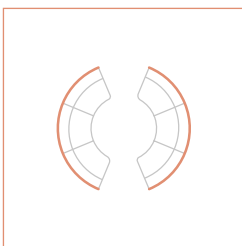

**MP25-30**  
Twin Entry Circular  
Meeting Pod  
  
Fits: 6x LS24D1 Small Curved  
Seater Sofas (Not Supplied)

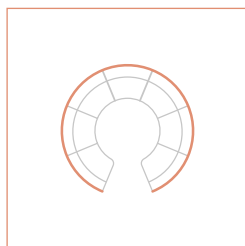

**MP26-30**  
Single Entry Circular  
Meeting Pod  
  
Fits: 7x LS24D1 Small Curved  
Seater Sofas (Not Supplied)

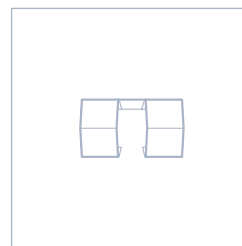

**MP17-13**  
4 User Meeting Pod  
with Angled Roofs  
  
Fits: 2x LS24B1 2 Seater Sofas  
and up to 1000w x 800d Dining  
Height Table (Not Supplied)

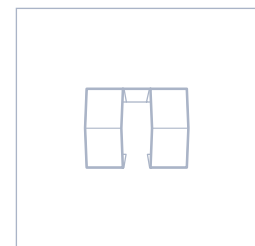

**MP17-18**  
6 User Meeting Pod  
with Angled Roofs  
  
Fits: 2x LS24C1 3 Seater Sofas  
and up to 1400w x 800d Dining  
Height Table (Not Supplied)

## MIRAGE POD & GE MOBILE FABRIC SELECTIONS

Fabric Selection 1	Fabric Selection 2	Fabric Selection 3	Fabric Selection 4
Camira Cara Camira Carlow	Camira Blazer Lite Inloom One	Camira Synergy 170 Camira Advantage	Camira Aspect Camira Blazer Camira Patina Camira Synergy Camira X2 Agua Buro Camira Canopy Camira Quest Agua Buro

Screens & Pods

## WALL DIMENSIONS

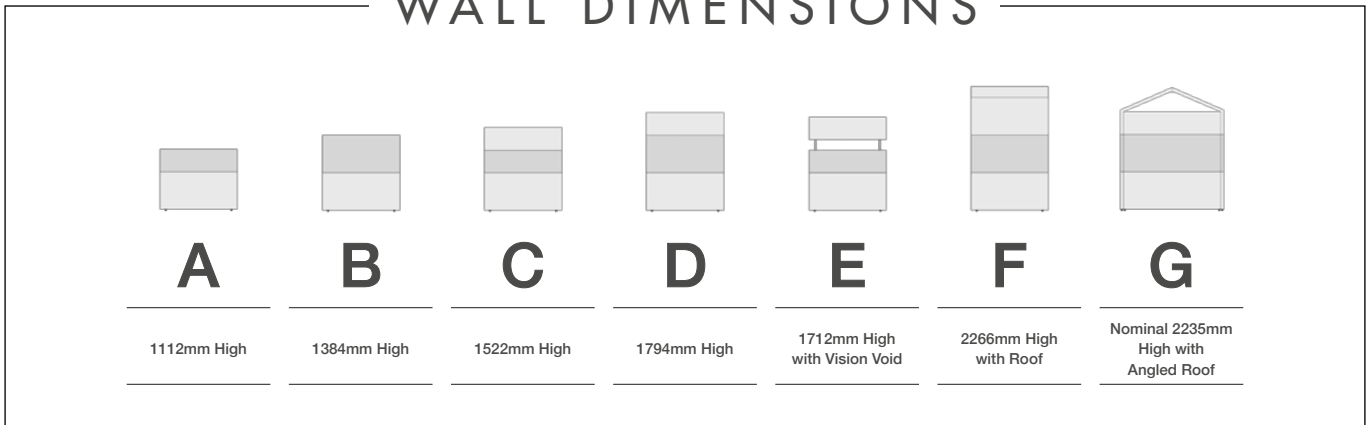

## OVERALL DIMENSIONS

GOBI			SONORAN			ATACAMA		
	OA Width	OA Depth		OA Width	OA Depth		OA Width	OA Depth
MP20R-12	1294	1108	MP1-10	1000	1200	MP7L-12	1255	1545
MP20L-12	1294	1108	MP1-14	1400	1200	MP7R-12	1255	1545
MP21R-18	1800	1559	MP3-10	1945	1200	MP7L-23	2455	2290
MP21L-18	1800	1559	MP3-14	2745	1200	MP7R-23	2455	2290
MP23-17	855	1710	MP5-10	2890	1200	MP7L-32	3655	3035
			MP5-14	4090	1200	MP7R-32	3655	3035
			MP6-10	2890	2400			
			MP6-14	4090	2400			
			MP2-10	1000	2400			
			MP2-14	1400	2400			
			MP4-10	1945	2400			
			MP4-14	2745	2400			
			MP14-29	2900	1400			
SAHARA			COLORADO			KARAKUM		
	OA Width	OA Depth		OA Width	OA Depth		OA Width	OA Depth
MP11-25	2500	2600	MP28-30	3110	1555	MP17-13	2400	1370
MP10-30	3000	3000	MP25-30	3110	2873	MP17-18	2400	1870
MP12-50	5000	2600	MP26-30	3110	2992			

## ELECTRICAL ACCESSORIES



**DTPT-20**  
1x UK Power & Twin  
USB Fast Charge 2x Cat 6 Data  
(Desk top fixing only)



**DTPT02U**  
2x UK Power & Twin  
USB Fast Charge  
(Desk top fixing only)



**CLWP3**  
Starter Cable 3000mm  
GST18/3 Female to 13A UK Plug



**MPDTPXT/DTPXT**  
1x UK Power & Twin  
USB Fast Charge  
(POA)



**DTPCA**  
Qi Compatible Aircharge Module  
with Black Inner & Aluminium Bezel  
(Desk top fixing only)



**DTPCB**  
Qi Compatible Aircharge Module  
with Black Inner & Black Bezel  
(Desk top fixing only)



**MPORT**  
80mm Dia. Circular  
Double Sided Cable Port (Black)  
(Wall panel fixing only £68 per port)



**MPORT**  
80mm Dia. Circular  
Double Sided Cable Port (Silver)  
(Wall panel fixing only £68 per port)



**MPORT**  
80mm Dia. Circular  
Double Sided Cable Port (White)  
(Wall panel fixing only £68 per port)

## STATIONERY ACCESSORIES



**VSTRA1**  
A4 Landscape Paper Tray  
Available in Black or Silver



**VSTRA2**  
A4 Portrait Paper Tray  
Available in Black or Silver



**VSTRA4**  
Stationery Tray  
Available in Black or Silver

## Fabric Selection 1

Please ensure when contacting our Sales Department full descriptions are used. Sales codes are made up of three elements: Product Code, Wall Height and Cable Management Type. For Cable Ports use 'P' and for Scallop Tops use 'S'.  
Example: Sonoran with Level Height B with Cable Port would read MP5-14-B-P.

### Key:

- Supplied with Cable Ports in Top Panel
- Supplied with PIR LED Lighting
- Option of Scallop/Cable Ports in Top Panel

### Height Options

- A 1112mm High
- B 1384mm High
- C 1522mm High
- D 1794mm High
- E 1712mm High with Vision Void
- F 2266mm High with Roof
- G Nominal 2235mm High with Angled Roof

### GOBI

Code	Description	A	B	C	D	E	F	G
MP20R-12	Single User Right Hand <span style="color: red;">■</span>	£3,537	£4,353	-	£5,761	-	-	-
MP20L-12	Single User Left Hand <span style="color: red;">■</span>	£3,537	£4,353	-	£5,761	-	-	-
MP21R-18	Single User Right Hand <span style="color: red;">■</span>	£3,870	£4,425	-	£5,576	-	-	-
MP21L-18	Single User Left Hand <span style="color: red;">■</span>	£3,870	£4,425	-	£5,576	-	-	-
MP23-17	Single User Semi Circular <span style="color: red;">■</span>	£2,028	£2,345	-	£3,407	-	-	-

### SONORAN

Code	Description	A	B	C	D	E	F	G
MP1-10	Small Single User <span style="color: blue;">■</span>	£2,919	£3,247	-	£4,569	£4,221	-	-
MP1-14	Large Single User <span style="color: blue;">■</span>	£3,037	£3,780	-	£4,891	£4,362	-	-
MP3-10	Small 2 User <span style="color: blue;">■</span>	£4,952	£5,432	-	£7,482	£7,341	-	-
MP3-14	Large 2 User <span style="color: blue;">■</span>	£5,041	£5,657	-	£7,723	£7,467	-	-
MP5-10	Small 3 User <span style="color: blue;">■</span>	£6,881	£7,135	-	£10,975	£11,144	-	-
MP5-14	Large 3 User <span style="color: blue;">■</span>	£7,782	£8,846	-	£12,334	£12,208	-	-
MP6-10	Small 6 Facing User <span style="color: blue;">■</span>	£14,064	£14,232	-	£19,659	£20,157	-	-
MP6-14	Large 6 Facing User <span style="color: blue;">■</span>	£14,185	£16,206	-	£21,102	£20,323	-	-
MP2-10	Small 2 Facing User <span style="color: blue;">■</span>	£5,032	£5,424	-	£7,501	£7,451	-	-
MP2-14	Large 2 Facing User <span style="color: blue;">■</span>	£5,141	£5,871	-	£7,965	£7,588	-	-
MP4-10	Small 4 Facing User <span style="color: blue;">■</span>	£9,674	£10,138	-	£13,989	£14,757	-	-
MP4-14	Large 4 Facing User <span style="color: blue;">■</span>	£10,292	£10,794	-	£14,568	£15,423	-	-
MP14-29	2 User Divider Wall <span style="color: red;">■</span>	-	£8,206	£10,470	£11,351	-	-	-

### ATACAMA

Code	Description	A	B	C	D	E	F	G
MP7L-12	2 User Left Hand <span style="color: blue;">■</span>	£2,714	£2,934	-	£4,123	-	-	-
MP7R-12	2 User Right Hand <span style="color: blue;">■</span>	£2,714	£2,934	-	£4,123	-	-	-
MP7L-23	4 User Left Hand <span style="color: blue;">■</span>	£4,601	£5,352	-	£6,944	-	-	-
MP7R-23	4 User Right Hand <span style="color: blue;">■</span>	£4,601	£5,352	-	£6,944	-	-	-
MP7L-32	6 User Left Hand <span style="color: blue;">■</span>	£6,786	£7,752	-	£10,140	-	-	-
MP7R-32	6 User Right Hand <span style="color: blue;">■</span>	£6,786	£7,752	-	£10,140	-	-	-

### SAHARA

Code	Description	A	B	C	D	E	F	G
MP11-25	Single Entry Square	-	-	£10,107	£12,314	-	£22,743	-
MP10-30	Single Entry Soft Square	-	-	£10,620	£13,834	-	£23,624	-
MP12-50	Twin Entry Rectangular	-	-	£16,422	£20,877	-	£38,295	-

### COLORADO

Code	Description	A	B	C	D	E	F	G
MP28-30	Semi Circular	-	£4,216	£4,813	£5,710	-	-	-
MP25-30	Twin Entry Circular	-	-	£7,335	£8,128	-	£13,778	-
MP26-30	Single Entry Circular	-	-	£8,180	£9,087	-	£15,342	-

### KARAKUM

Code	Description	A	B	C	D	E	F	G
MP17-13	4 User Angled Roof <span style="color: yellow;">■</span>	-	-	-	-	-	-	£15,508
MP17-18	6 User Angled Roof <span style="color: yellow;">■</span>	-	-	-	-	-	-	£17,392



## Fabric Selection 2

Please ensure when contacting our Sales Department full descriptions are used. Sales codes are made up of three elements: Product Code, Wall Height and Cable Management Type. For Cable Ports use 'P' and for Scallop Tops use 'S'.  
Example: Sonoran with Level Height B with Cable Port would read MP5-14-B-P.

### Key:

- Supplied with Cable Ports in Top Panel
- Supplied with PIR LED Lighting
- Option of Scallop/Cable Ports in Top Panel

### Height Options

- A 1112mm High
- B 1384mm High
- C 1522mm High
- D 1794mm High
- E 1712mm High with Vision Void
- F 2266mm High with Roof
- G Nominal 2235mm High with Angled Roof

### GOBI

Code	Description	A	B	C	D	E	F	G
MP20R-12	Single User Right Hand <span style="color: red;">■</span>	£3,649	£4,412	-	£5,783	-	-	-
MP20L-12	Single User Left Hand <span style="color: red;">■</span>	£3,649	£4,412	-	£5,783	-	-	-
MP21R-18	Single User Right Hand <span style="color: red;">■</span>	£3,930	£4,550	-	£5,884	-	-	-
MP21L-18	Single User Left Hand <span style="color: red;">■</span>	£3,930	£4,550	-	£5,884	-	-	-
MP23-17	Single User Semi Circular <span style="color: red;">■</span>	£2,155	£2,465	-	£3,508	-	-	-

### SONORAN

Code	Description	A	B	C	D	E	F	G
MP1-10	Small Single User <span style="color: blue;">■</span>	£2,937	£3,300	-	£4,613	£4,525	-	-
MP1-14	Large Single User <span style="color: blue;">■</span>	£3,110	£3,859	-	£5,191	£5,122	-	-
MP3-10	Small 2 User <span style="color: blue;">■</span>	£5,765	£6,171	-	£8,686	£8,754	-	-
MP3-14	Large 2 User <span style="color: blue;">■</span>	£6,036	£6,718	-	£9,252	£9,078	-	-
MP5-10	Small 3 User <span style="color: blue;">■</span>	£7,761	£8,236	-	£11,666	£11,860	-	-
MP5-14	Large 3 User <span style="color: blue;">■</span>	£8,516	£9,441	-	£12,968	£12,749	-	-
MP6-10	Small 6 Facing User <span style="color: blue;">■</span>	£14,644	£14,942	-	£20,616	£21,375	-	-
MP6-14	Large 6 Facing User <span style="color: blue;">■</span>	£15,098	£17,112	-	£22,897	£21,974	-	-
MP2-10	Small 2 Facing User <span style="color: blue;">■</span>	£5,841	£6,455	-	£8,923	£8,788	-	-
MP2-14	Large 2 Facing User <span style="color: blue;">■</span>	£6,063	£7,052	-	£9,628	£9,134	-	-
MP4-10	Small 4 Facing User <span style="color: blue;">■</span>	£10,513	£10,972	-	£15,101	£15,410	-	-
MP4-14	Large 4 Facing User <span style="color: blue;">■</span>	£10,969	£11,995	-	£16,232	£16,002	-	-
MP14-29	2 User Divider Wall <span style="color: red;">■</span>	-	£8,457	£10,692	£11,377	-	-	-

### ATACAMA

Code	Description	A	B	C	D	E	F	G
MP7L-12	2 User Left Hand <span style="color: blue;">■</span>	£2,750	£3,036	-	£4,184	-	-	-
MP7R-12	2 User Right Hand <span style="color: blue;">■</span>	£2,750	£3,036	-	£4,184	-	-	-
MP7L-23	4 User Left Hand <span style="color: blue;">■</span>	£5,145	£5,760	-	£7,673	-	-	-
MP7R-23	4 User Right Hand <span style="color: blue;">■</span>	£5,145	£5,760	-	£7,673	-	-	-
MP7L-32	6 User Left Hand <span style="color: blue;">■</span>	£7,614	£8,517	-	£11,311	-	-	-
MP7R-32	6 User Right Hand <span style="color: blue;">■</span>	£7,614	£8,517	-	£11,311	-	-	-

### SAHARA

Code	Description	A	B	C	D	E	F	G
MP11-25	Single Entry Square	-	-	£10,541	£12,630	-	£23,482	-
MP10-30	Single Entry Soft Square	-	-	£10,802	£13,965	-	£24,211	-
MP12-50	Twin Entry Rectangular	-	-	£16,916	£21,166	-	£39,508	-

### COLORADO

Code	Description	A	B	C	D	E	F	G
MP28-30	Semi Circular	-	£4,272	£5,011	£5,896	-	-	-
MP25-30	Twin Entry Circular	-	-	£7,503	£8,834	-	£15,591	-
MP26-30	Single Entry Circular	-	-	£8,756	£10,313	-	£17,857	-

### KARAKUM

Code	Description	A	B	C	D	E	F	G
MP17-13	4 User Angled Roof <span style="color: yellow;">■</span>	-	-	-	-	-	-	£16,018
MP17-18	6 User Angled Roof <span style="color: yellow;">■</span>	-	-	-	-	-	-	£17,551

## Fabric Selection 3

Please ensure when contacting our Sales Department full descriptions are used. Sales codes are made up of three elements: Product Code, Wall Height and Cable Management Type. For Cable Ports use 'P' and for Scallop Tops use 'S'.  
Example: Sonoran with Level Height B with Cable Port would read MP5-14-B-P.

### Key:

- Supplied with Cable Ports in Top Panel
- Supplied with PIR LED Lighting
- Option of Scallop/Cable Ports in Top Panel

### Height Options

- A 1112mm High
- B 1384mm High
- C 1522mm High
- D 1794mm High
- E 1712mm High with Vision Void
- F 2266mm High with Roof
- G Nominal 2235mm High with Angled Roof

### GOBI

Code	Description		A	B	C	D	E	F	G
MP20R-12	Single User Right Hand	■	£3,853	£4,788	-	£6,279	-	-	-
MP20L-12	Single User Left Hand	■	£3,853	£4,788	-	£6,279	-	-	-
MP21R-18	Single User Right Hand	■	£5,297	£5,538	-	£7,502	-	-	-
MP21L-18	Single User Left Hand	■	£5,297	£5,538	-	£7,502	-	-	-
MP23-17	Single User Semi Circular	■	£3,001	£3,535	-	£4,787	-	-	-

### SONORAN

Code	Description		A	B	C	D	E	F	G
MP1-10	Small Single User	■	£3,753	£4,155	-	£5,089	£4,991	-	-
MP1-14	Large Single User	■	£3,926	£4,634	-	£5,978	£5,650	-	-
MP3-10	Small 2 User	■	£6,352	£6,799	-	£9,586	£9,662	-	-
MP3-14	Large 2 User	■	£6,643	£7,397	-	£10,205	£10,013	-	-
MP5-10	Small 3 User	■	£8,545	£9,067	-	£12,870	£13,087	-	-
MP5-14	Large 3 User	■	£9,367	£10,389	-	£14,300	£14,058	-	-
MP6-10	Small 6 Facing User	■	£16,132	£16,471	-	£22,760	£23,594	-	-
MP6-14	Large 6 Facing User	■	£16,622	£17,921	-	£24,127	£23,870	-	-
MP2-10	Small 2 Facing User	■	£6,434	£7,113	-	£9,851	£9,705	-	-
MP2-14	Large 2 Facing User	■	£6,674	£7,767	-	£10,623	£10,078	-	-
MP4-10	Small 4 Facing User	■	£11,587	£12,104	-	£16,681	£17,016	-	-
MP4-14	Large 4 Facing User	■	£12,076	£13,045	-	£17,920	£17,657	-	-
MP14-29	2 User Divider Wall	■	-	£8,854	£11,200	£12,480	-	-	-

### ATACAMA

Code	Description		A	B	C	D	E	F	G
MP7L-12	2 User Left Hand	■	£3,003	£3,321	-	£4,590	-	-	-
MP7R-12	2 User Right Hand	■	£3,003	£3,321	-	£4,590	-	-	-
MP7L-23	4 User Left Hand	■	£5,610	£6,292	-	£8,411	-	-	-
MP7R-23	4 User Right Hand	■	£5,610	£6,292	-	£8,411	-	-	-
MP7L-32	6 User Left Hand	■	£8,300	£9,303	-	£12,398	-	-	-
MP7R-32	6 User Right Hand	■	£8,300	£9,303	-	£12,398	-	-	-

### SAHARA

Code	Description		A	B	C	D	E	F	G
MP11-25	Single Entry Square		-	-	£11,155	£13,257	-	£25,314	-
MP10-30	Single Entry Soft Square		-	-	£11,760	£14,661	-	£25,423	-
MP12-50	Twin Entry Rectangular		-	-	£18,437	£22,224	-	£41,486	-

### COLORADO

Code	Description		A	B	C	D	E	F	G
MP28-30	Semi Circular		-	£4,693	£5,498	£6,472	-	-	-
MP25-30	Twin Entry Circular		-	-	£8,239	£9,701	-	£17,129	-
MP26-30	Single Entry Circular		-	-	£9,614	£11,323	-	£19,614	-

### KARAKUM

Code	Description		A	B	C	D	E	F	G
MP17-13	4 User Angled Roof	■	-	-	-	-	-	-	£16,809
MP17-18	6 User Angled Roof	■	-	-	-	-	-	-	£18,855

## Fabric Selection 4

Please ensure when contacting our Sales Department full descriptions are used. Sales codes are made up of three elements: Product Code, Wall Height and Cable Management Type. For Cable Ports use 'P' and for Scallop Tops use 'S'.  
Example: Sonoran with Level Height B with Cable Port would read MP5-14-B-P.

### Key:

- Supplied with Cable Ports in Top Panel
- Supplied with PIR LED Lighting
- Option of Scallop/Cable Ports in Top Panel

### Height Options

- A 1112mm High
- B 1384mm High
- C 1522mm High
- D 1794mm High
- E 1712mm High with Vision Void
- F 2266mm High with Roof
- G Nominal 2235mm High with Angled Roof

### GOBI



Code	Description		A	B	C	D	E	F	G
MP20R-12	Single User Right Hand	■	£3,924	£4,845	-	£6,407	-	-	-
MP20L-12	Single User Left Hand	■	£3,924	£4,845	-	£6,407	-	-	-
MP21R-18	Single User Right Hand	■	£5,647	£6,324	-	£8,222	-	-	-
MP21L-18	Single User Left Hand	■	£5,647	£6,324	-	£8,222	-	-	-
MP23-17	Single User Semi Circular	■	£3,390	£3,955	-	£5,187	-	-	-

### SONORAN

Code	Description		A	B	C	D	E	F	G
MP1-10	Small Single User	■	£4,036	£4,845	-	£6,374	£5,852	-	-
MP1-14	Large Single User	■	£4,195	£5,271	-	£6,823	£6,044	-	-
MP3-10	Small 2 User	■	£6,796	£7,467	-	£10,339	£10,142	-	-
MP3-14	Large 2 User	■	£6,887	£7,744	-	£10,637	£10,285	-	-
MP5-10	Small 3 User	■	£9,348	£9,620	-	£13,546	£13,944	-	-
MP5-14	Large 3 User	■	£9,474	£10,957	-	£14,883	£14,124	-	-
MP6-10	Small 6 Facing User	■	£16,106	£16,547	-	£22,840	£23,446	-	-
MP6-14	Large 6 Facing User	■	£16,677	£18,276	-	£24,600	£24,091	-	-
MP2-10	Small 2 Facing User	■	£6,920	£7,467	-	£10,381	£10,314	-	-
MP2-14	Large 2 Facing User	■	£7,032	£8,056	-	£10,988	£10,460	-	-
MP4-10	Small 4 Facing User	■	£11,856	£12,376	-	£17,119	£17,368	-	-
MP4-14	Large 4 Facing User	■	£12,222	£13,178	-	£17,943	£17,784	-	-
MP14-29	2 User Divider Wall	■	-	£8,897	£11,899	£12,399	-	-	-

### ATACAMA

Code	Description		A	B	C	D	E	F	G
MP7L-12	2 User Left Hand	■	£3,763	£4,438	-	£5,772	-	-	-
MP7R-12	2 User Right Hand	■	£3,763	£4,438	-	£5,772	-	-	-
MP7L-23	4 User Left Hand	■	£6,129	£7,202	-	£9,430	-	-	-
MP7R-23	4 User Right Hand	■	£6,129	£7,202	-	£9,430	-	-	-
MP7L-32	6 User Left Hand	■	£8,933	£10,203	-	£13,555	-	-	-
MP7R-32	6 User Right Hand	■	£8,933	£10,203	-	£13,555	-	-	-

### SAHARA

Code	Description		A	B	C	D	E	F	G
MP11-25	Single Entry Square		-	-	£11,476	£13,678	-	£22,543	-
MP10-30	Single Entry Soft Square		-	-	£12,074	£15,378	-	£26,296	-
MP12-50	Twin Entry Rectangular		-	-	£18,662	£23,196	-	£42,552	-

### COLORADO

Code	Description		A	B	C	D	E	F	G
MP28-30	Semi Circular		-	£6,105	£6,659	£7,438	-	-	-
MP25-30	Twin Entry Circular		-	-	£9,445	£10,382	-	£17,615	-
MP26-30	Single Entry Circular		-	-	£10,512	£11,584	-	£19,597	-

### KARAKUM

Code	Description		A	B	C	D	E	F	G
MP17-13	4 User Angled Roof	■	-	-	-	-	-	-	£17,091
MP17-18	6 User Angled Roof	■	-	-	-	-	-	-	£19,182

# MIRAGE HAZE SCREENS & PODS

5 Year  
Guarantee

Mirage Haze is a customisable alternative for break-out spaces. The metal framework can be specified to create boundless potentials of shapes and sizes to suit the ergonomic needs of the office environment. Walls can be specified in a trio of finishes, including upholstery, glass and laminate (available on request). Enhanced by the addition of sound-absorbing ceiling tiles, infrared lighting technology, and fans that provide air circulation, this pod's space utilisation is decisively maximised.

#### Additional Information:

- Prices do not include installation which is mandatory by Gresham qualified installers. Installation costs will be an additional charge and will be supplied on completion of a Gresham consultation or site survey form.
- Prices include posts, cross rails, ceiling, lighting, sliding door, all fixings and all panels.
- All pods are 2200mm high.
- For any pods with dividing walls, the dividing wall will be upholstered in fabric.
- Available with Silver, White or Black trim.

Screens & Pods

Description	Code	Width	Depth	Footprint (m <sup>2</sup> )	Suitable For	Recommended Table	Band 1	Band 2	Ceiling Cover
<b>Square</b>									
Half Glazed	MHS2020HG	2000 x	2000	4	1 person	Ø800	£15,847	£16,997	£1,812
Half Glazed	MHS2525HG	2500 x	2500	6.25	3 people	Ø800	£22,185	£23,745	£2,826
Half Glazed	MHS3030HG	3000 x	3000	9	4 people	Ø1000	£24,176	£25,828	£4,075
1 Wall Glazed	MHS2020WG	2000 x	2000	4	1 person	Ø800	£16,845	£18,567	£1,812
1 Wall Glazed	MHS2525WG	2500 x	2500	6.25	3 people	Ø800	£22,576	£26,271	£2,826
1 Wall Glazed	MHS3030WG	3000 x	3000	9	4 people	Ø1000	£25,610	£28,088	£4,075
<b>Rectangular</b>									
Half Glazed	MHR1520HG	1500 x	2000	3	1 person	1200 x 800 or Ø800	£14,692	£15,346	£1,359
Half Glazed	MHR2030HG	2000 x	3000	6	2 people	Ø800	£23,172	£24,610	£2,712
Half Glazed	MHR2530HG	2500 x	3000	7.5	3 people	Ø800	£26,623	£28,344	£3,654
Half Glazed	MHR2540HG	2500 x	4000	10	3 people	Ø1000	£29,946	£31,954	£4,527
Half Glazed	MHR3040HG	3000 x	4000	12	6 people	1800 x 1000	£30,860	£32,513	£5,432
Half Glazed	MHR3050HG	3000 x	5000	15	6 people	2000 x 1000	£35,404	£37,698	£6,790
1 Wall Glazed	MHR1520WG	1500 x	2000	3	1 person	1200 x 800 or Ø800	£14,919	£16,192	£1,359
1 Wall Glazed	MHR2030WG	2000 x	3000	6	2 people	Ø800	£23,399	£25,456	£2,712
1 Wall Glazed	MHR2530WG	2500 x	3000	7.5	3 people	Ø800	£26,966	£29,615	£3,654
1 Wall Glazed	MHR2540WG	2500 x	4000	10	3 people	Ø1000	£30,288	£33,225	£4,527
1 Wall Glazed	MHR3040WG	3000 x	4000	12	6 people	1800 x 1000	£31,201	£33,782	£5,432
1 Wall Glazed	MHR3050WG	3000 x	5000	15	6 people	2000 x 1000	£35,747	£38,966	£6,790
<b>Rectangular Divide</b>									
Half Glazed	MHR5025DHG	5000 x	2500	12.5	6 people	Ø800 x2	£36,906	£39,846	£5,660
Half Glazed	MHR4030DHG	4000 x	3000	12	4 people	Ø800 x2	£35,151	£37,604	£5,432
Half Glazed	MHR5030DHG	5000 x	3000	15	6 people	Ø800 x2	£40,914	£44,121	£6,790
Half Glazed	MHR6030DHG	6000 x	3000	18	8 people	Ø1000 x2	£43,911	£47,093	£8,148
1 Wall Glazed	MHR5025DWG	5000 x	2500	12.5	6 people	Ø800 x2	£37,589	£42,386	£5,660
1 Wall Glazed	MHR4030DWG	4000 x	3000	12	4 people	Ø800 x2	£35,834	£40,143	£5,432
1 Wall Glazed	MHR5030DWG	5000 x	3000	15	6 people	Ø800 x2	£41,598	£46,662	£6,790
1 Wall Glazed	MHR6030DWG	6000 x	3000	18	8 people	Ø1000 x2	£44,592	£49,631	£8,148
<b>Circular</b>									
Half Glazed	MHC30HG	Ø3170		7	4 people	Ø1000	£21,496	£23,338	£3,169
1 Wall Glazed	MHC30WG	Ø3170		7	4 people	Ø1000	£24,385	£25,007	£3,169
<b>Half Loop</b>									
Half Glazed	MHH2530HG	2500 x	3170	7.5	3 people	Ø800	£28,430	£29,682	£3,654
Half Glazed	MHH3030HG	3000 x	3170	9	4 people	Ø1000	£28,670	£30,265	£4,075
Half Glazed	MHH4030HG	4000 x	3170	12	5 people	1800 x 1000	£32,507	£34,822	£5,432
Half Glazed	MHH5030HG	5000 x	3170	14	6 people	2000 x 1000	£36,774	£38,783	£6,337

Mirage Haze is flexible, for alternative footprints and heights please contact our Sales Department.

Office pod system integrated with sound-insulating properties. Tested to BS EN ISO 140-4:1998 and has a noise absorption rate of 28-30dB. Please note a Ceiling Cover may only be required when the top of the pod is visible from above (near stairs, atriums etc) to hide electrics. Air Circulation unit cannot be covered. The Ceiling Cover is fabric wrapped to match the internal fabric of the pod ceiling.

## ACCESSORIES

Accessories must be specified at point of order.



Slow Door Closure  
MH/SDC  
£714



Monitor Mount - Large  
MH/MM2  
£706



Door Lock  
MH/DL  
£714



Air Circulation  
MH/AC  
£1,554



Sound Absorbing Underlay  
MH/UNDERLAY  
POA

RECTANGULAR PODS ONLY

RECTANGULAR PODS ONLY



## OPTIONAL FEATURES

Optional features must be specified at point of order.

### Manifestations - Spots

Opal frosted vinyl spots are supplied on all doors as standard and are available on other glazed panels as an option.

Code	Description	Price
MHSPOT50	Opal frosted vinyl spots (50) Vinyl artwork or logos	£269 POA

(Diagram shows opal frosted vinyl spots double row of 50. This complies with The Building Regulations 2010, part K5)

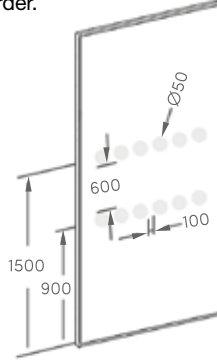

## FABRIC OPTIONS

**Band 1**  
Camira Carlow  
Camira Manhattan  
Camira Sonus  
Camira Cara

**Band 2**  
Camira Blazer  
Camira Blazer Lite  
Camira Main Line Flax  
Camira Main Line Plus  
Camira Synergy  
Agua Buro  
Inloom Jet Bioactive  
Inloom One  
Inloom Roccia

### Outlet Type/Quantities

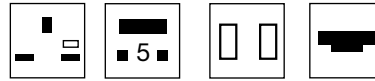

### Electrics

- Posts can be positioned in any wall except where sliding doors hang or in the corners of a pod.
- All leads are 3m long from termination point at top/bottom of post. Longer leads are available (POA).
- Supplied as 2 gang or 1 gang sockets in Black or Silver with Black fascias, containing the following options:
- Outlets are positioned 800mm from floor as standard.

Code	UK POWER	CAT 5e DATA	TWIN USB FAST CHARGE	HDMI	Price
MH/2P/1D	2	1	-	-	£1,218
MH/2P/1H	2	-	-	1	£1,381
MH/1H	-	-	-	1	£1,135
MH/1H/1D	-	1	-	1	£1,282
MH/1D	-	1	-	-	£719
MH/1T	-	-	1	-	£1,005
MH/1P/1T	1	-	1	-	£1,059
MH/2P	2	-	-	-	£729



Mirage Haze Square Half Glazed

# MIRAGE HAZE PHONE BOOTH SCREENS & PODS



The Mirage Haze phone booth has improved acoustics (rated at 36dB noise reduction) and an updated modern aesthetic. To achieve the improved acoustics, 22mm double glazed panels, 6mm glazed doors, 55mm sound absorbing upholstered panels and 50mm sound absorbing ceiling tiles have been utilised. The design includes an integrated facilities loop housing the PIR operated LED strip lighting and air circulation system.

**Additional Information:**

- Prices do not include installation which is mandatory by Gresham qualified installers. Installation costs will be an additional charge and will be supplied on completion of a Gresham consultation or site survey form.
- Acoustically tested to BSEN ISO 140 and rated at 36dB noise reduction.
- 55mm sound absorbing upholstered panels.
- 22mm double glazed glass panels.
- 6mm hinged glass door with manifestations.
- 50mm sound absorbing ceiling panels upholstered in light grey.
- Integrated ceiling cover included as standard.
- Integrated facilities arch included as standard housing lighting system.
- PIR operated, high output – low voltage, diffused, dual LED strip lighting included as standard.
- Air circulation fan with 216m3/h airflow included as standard.
- Optional flush mounted modules available with power or TUF.
- 2100mm high (2380mm high with air circulation).
- Available with optional shelf. £360 (White or Black)
- Available with Silver, White or Black trim.

Screens & Pods

Description	Code	Width	Depth	Footprint (m²)	Suitable For	Recommended Table	Band 1	Band 2	Ceiling Cover
1 Wall Glazed	MZ1WG	1000	x 1000	1	1 person	N/A	£14,331	£15,303	INC.



5 Year  
Guarantee

NEW  
PRODUCT

# MIRAGE HAZE PHONE BOOTH SCREENS & PODS



Screens & Pods

# GE MOBILE PODS

## SCREENS & PODS



GE Mobile Pods are one of a kind in flexibility and sociability. Create a customisable meeting space with pods on castors. Personalise an away-from-desk space with a selection of fabrics and MFC finishes that create a fun and informal way to socialise.

Additional Information:  
Fabric Selections as per Mirage Pods.



Screens & Pods

Code	Thumbnail	Description	Price	Fabric Selection 3	Fabric Selection 4
GE21A1		<b>2 User Mobile Meeting Pod</b> Angled Roof & Integrated Seating 2400w x 700d x 2235h (Seat height 460mm)  Optional LED PIR Lighting (suffix L) <b>GE21KIT1</b> Linking Kit	£1,956 £153	£8,792	£9,129
GE21B1		<b>2 User Mobile Meeting Pod</b> Angled Roof, Back Panel & Integrated Seating 2400w x 755d x 2235h (Seat height 460mm)  Optional LED PIR Lighting (suffix L) Optional TV/ Monitor mount bracket (suffix T) <b>GE21KIT1</b> Linking Kit	£1,956 £461 £153		£12,847
GE22A1		<b>2 User Mobile Meeting Pod</b> Angled Roof & Integrated Full Width Table 2400w x 700d x 2235h <i>(must be linked to one of the above)</i>  Optional LED PIR Lighting (suffix L) <b>GE21KIT1</b> Linking Kit	£1,956 £153		£7,247
GE23A1		<b>Rectangular Upholstered Centre Cube</b> Fitted with Glides 1000w x 700d x 460h (Seat height 460mm)			£920

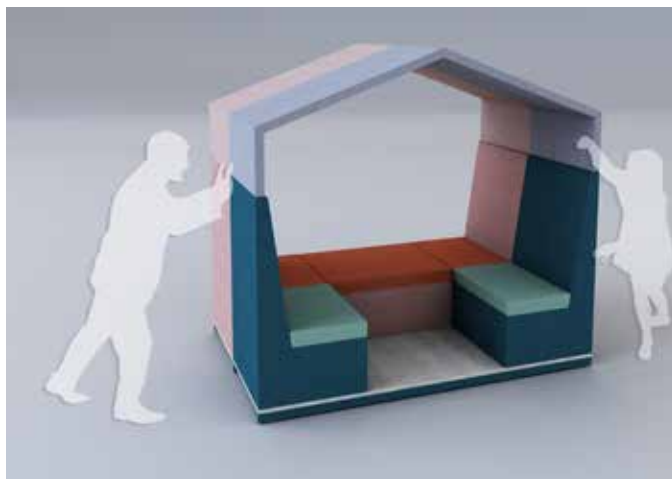



## EXAMPLE CONFIGURATIONS

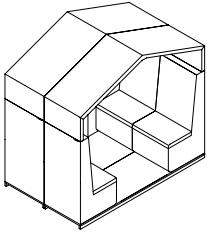

2x GE21A1  
1x GE21KIT1

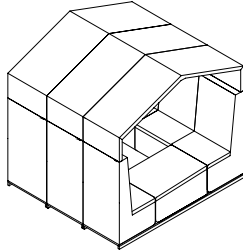

3x GE21A1  
1x GE23A1  
2x GE21KIT1

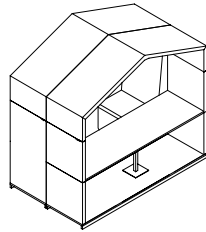

1x GE21A1  
1x GE22A1  
1x GE21KIT1

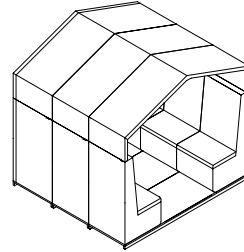

2x GE21A1  
1x GE21B1  
2x GE21KIT1

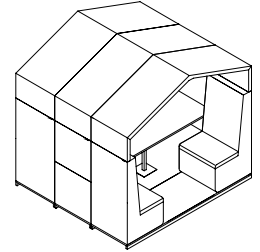

2x GE21A1  
1x GE22A1  
2x GE21KIT1

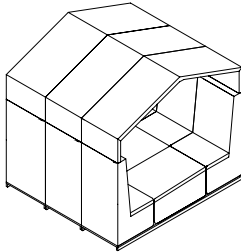

3x GE21A1  
3x GE23A1  
2x GE21KIT1

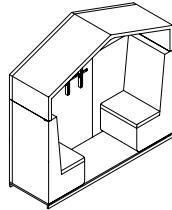

1x GE21B1T

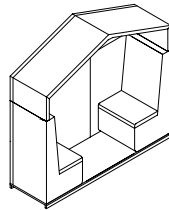

1x GE21B1

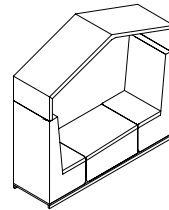

1x GE21A1  
1x GE23A1

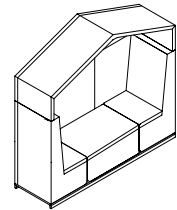

1x GE21B1  
1x GE23A1



GE21A1 with GE23A1 Centre Cube

# GE6 MOBILE SCREENS & PODS



Floor standing mobile privacy panels available as rectangular or curved in various heights. GE6 Mobile can be used to partition offices to create collaborative areas.

These screens can be upholstered in a choice of vibrant fabrics that not only help to delineate user space but also can add colour highlights to modern workplace environments.

**Additional Information:**

- Fabric wrapped, prices shown are for single fabrics only.
- Available with 4 or 6 panels.
- Supplied with base in black, white, silver or grey as standard.
- Supplied with castors.

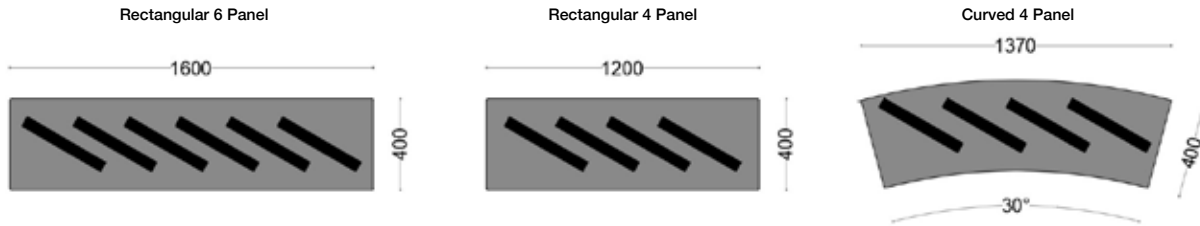

Screens & Pods

Code	Overall Height	Panel Width	Cara Carlow	Blazer/ Synergy/ Aspect/Patina/X2/ Agua Buro Inloom Jet Bioactive/ Roccia		
				Blazer Lite Sonus		
<b>Rectangular 4 Panel</b>						
GE6A1	1200	x	400	£2,627	£2,854	£2,870
GE6A2	1600	x	400	£2,874	£2,905	£3,362
GE6A3	1800	x	400	£2,982	£3,564	£3,578
<b>Rectangular 6 Panel</b>						
GE6B1	1200	x	400	£3,365	£3,700	£3,724
GE6B2	1600	x	400	£3,733	£3,780	£4,464
GE6B3	1800	x	400	£3,897	£4,766	£4,790
<b>Curved 4 Panel</b>						
GE6E1	1200	x	400	£4,684	£4,959	£5,081
GE6E2	1600	x	400	£4,936	£4,995	£5,724
GE6E3	1800	x	400	£4,955	£5,501	£5,741



Rectangular 4 Panel GE6 Mobile with White Base

Floor standing static privacy panels available as rectangular in two widths and two heights. GE6 Static is supplied with heavyweight base and can be used to partition offices to create collaborative areas.

These screens can be upholstered in a choice of vibrant fabrics that not only help to delineate user space but also can add colour highlights to modern workplace environments.

**Additional Information:**

- Fabric wrapped, prices shown are for single fabrics only.
- Available with 3 or 4 panels.
- Supplied with base in black, white, silver or grey as standard.



**Rectangular 3 Panel**

**Rectangular 4 Panel**

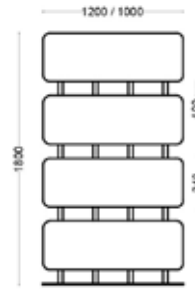
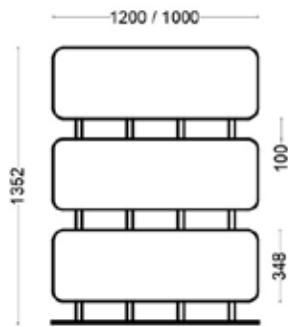

Blazer/ Synergy/  
Aspect/Patina/X2/  
Agua Buro  
Inloom Jet  
Bioactive/  
Roccia

Code	Overall Height		Panel Width	Cara Carlow	Blazer Lite Sonus	Blazer/ Synergy/ Aspect/Patina/X2/ Agua Buro Inloom Jet Bioactive/ Roccia
<b>Rectangular 3 Panel</b>						
GE6C1	1352	x	1000	£2,712	£2,892	£2,994
GE6D1	1352	x	1200	£2,730	£2,916	£3,017
<b>Rectangular 4 Panel</b>						
GE6C2	1800	x	1000	£3,149	£3,391	£3,525
GE6D2	1800	x	1200	£3,177	£3,418	£3,555



Rectangular 4 Panel Static GE6

# GOF DESK MOUNTED SCREENS & PODS

5 Year  
Guarantee

Desk mounted screens can be used to reduce sound throughout a room whilst delineating personal space on desk clusters.



- Available in straight and wave-topped options.
- Aluminium frame includes integral tool-bar to top edge.
- Taller screens include additional tool-bar to centre.
- Fabric covered panels are offered in a selection of fabrics.

Screens & Pods

Code	Where used	W	D	H	Band 1	Band 2	Band 3
<b>280mm High Straight - Fabric</b>							
VSDF213	2030	1998	x 30	x 280	£381	£410	£452
VSDF203	2000	1968	x 30	x 280	£379	£407	£448
VSDF183	1800	1768	x 30	x 280	£336	£356	£401
VSDF173	1630	1598	x 30	x 280	£262	£276	£320
VSDF163	1600	1568	x 30	x 280	£261	£273	£318
VSDF143	1400	1368	x 30	x 280	£223	£238	£281
VSDF123	1200	1168	x 30	x 280	£213	£230	£276
VSDF103	1000	968	x 30	x 280	£206	£222	£265
VSDF083	800	768	x 30	x 280	£192	£213	£258
VSDF063	600	568	x 30	x 280	£178	£188	£230

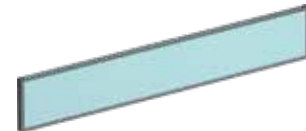

<b>380mm High Straight - Fabric</b>							
VSDF214	2030	1998	x 30	x 380	£404	£424	£465
VSDF204	2000	1968	x 30	x 380	£401	£420	£463
VSDF184	1800	1768	x 30	x 380	£362	£379	£424
VSDF174	1630	1598	x 30	x 380	£282	£299	£341
VSDF164	1600	1568	x 30	x 380	£281	£298	£339
VSDF144	1400	1368	x 30	x 380	£237	£257	£300
VSDF124	1200	1168	x 30	x 380	£229	£246	£289
VSDF104	1000	968	x 30	x 380	£222	£235	£276
VSDF084	800	768	x 30	x 380	£202	£209	£254
VSDF064	600	568	x 30	x 380	£195	£201	£241

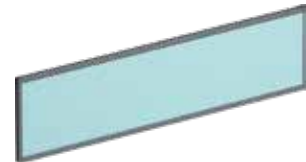

<b>480mm High Straight - Fabric</b>							
VSDF215	2030	1998	x 30	x 480	£441	£463	£505
VSDF205	2000	1968	x 30	x 480	£438	£460	£500
VSDF185	1800	1768	x 30	x 480	£401	£419	£462
VSDF175	1630	1598	x 30	x 480	£356	£376	£419
VSDF165	1600	1568	x 30	x 480	£343	£361	£403
VSDF145	1400	1368	x 30	x 480	£287	£300	£342
VSDF125	1200	1168	x 30	x 480	£273	£292	£335
VSDF105	1000	968	x 30	x 480	£266	£281	£325
VSDF085	800	768	x 30	x 480	£223	£230	£273
VSDF065	600	568	x 30	x 480	£211	£222	£265



<b>380/180mm High Wave - Fabric</b>							
VSDF214W	2030	1998	x 30	x 380/180	£479	£496	£540
VSDF204W	2000	1968	x 30	x 380/180	£477	£494	£534
VSDF184W	1800	1768	x 30	x 380/180	£419	£441	£485
VSDF174W	1630	1598	x 30	x 380/180	£362	£376	£419
VSDF164W	1600	1568	x 30	x 380/180	£361	£374	£418
VSDF144W	1400	1368	x 30	x 380/180	£350	£367	£409
VSDF124W	1200	1168	x 30	x 380/180	£330	£346	£389
VSDF104W	1000	968	x 30	x 380/180	£322	£339	£380
VSDF084W	800	768	x 30	x 380/180	£282	£292	£335

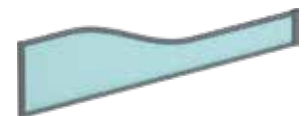

<b>480/280mm High Wave - Fabric</b>							
VSDF215W	2030	1998	x 30	x 480/280	£510	£532	£576
VSDF205W	2000	1968	x 30	x 480/280	£505	£530	£574
VSDF185W	1800	1768	x 30	x 480/280	£452	£473	£516
VSDF175W	1630	1598	x 30	x 480/280	£404	£421	£464
VSDF165W	1600	1568	x 30	x 480/280	£403	£419	£462
VSDF145W	1400	1368	x 30	x 480/280	£372	£386	£428
VSDF125W	1200	1168	x 30	x 480/280	£355	£372	£414
VSDF105W	1000	968	x 30	x 480/280	£342	£362	£404
VSDF085W	800	768	x 30	x 480/280	£298	£310	£352

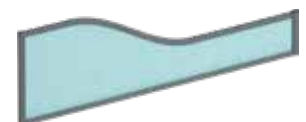

<b>480mm High Fabric with Integral Toolbar</b>							
Additional toolbar at 280mm high.							
VSDFT185	1800	1768	x 30	x 480	£443	£458	£486
VSDFT175	1630	1598	x 30	x 480	£404	£421	£464
VSDFT165	1600	1568	x 30	x 480	£377	£399	£441
VSDFT145	1400	1368	x 30	x 480	£323	£342	£384
VSDFT125	1200	1168	x 30	x 480	£293	£314	£355
VSDFT105	1000	968	x 30	x 480	£287	£301	£343
VSDFT085	800	768	x 30	x 480	£238	£256	£299

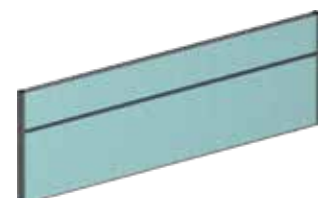

Code      Where used      W      D      H

**480mm High Perforated Steel/Fabric with Integral Toolbar**

Additional toolbar at 280mm high.

VSDST185	1800	1768	x	30	x	480
VSDST175	1630	1598	x	30	x	480
VSDST165	1600	1568	x	30	x	480
VSDST145	1400	1368	x	30	x	480
VSDST125	1200	1168	x	30	x	480
VSDST105	1000	968	x	30	x	480
VSDST085	800	768	x	30	x	480

Band 1	Band 2	Band 3	Colour Surcharge
£494	£514	£557	-
£413	£428	£473	-
£399	£409	£451	-
£372	£381	£426	-
£346	£362	£404	-
£319	£330	£374	-
£299	£314	£355	-

**480mm High Acrylic/Fabric with Integral Toolbar**

Additional toolbar at 280mm high.

VSDAT185	1800	1768	x	30	x	480
VSDAT175	1630	1598	x	30	x	480
VSDAT165	1600	1568	x	30	x	480
VSDAT145	1400	1368	x	30	x	480
VSDAT125	1200	1168	x	30	x	480
VSDAT105	1000	968	x	30	x	480
VSDAT085	800	768	x	30	x	480

£440	£462	£504	£33
£343	£361	£403	£33
£341	£356	£399	£33
£320	£332	£376	£33
£298	£314	£355	£33
£273	£291	£333	£33
£254	£262	£306	£33

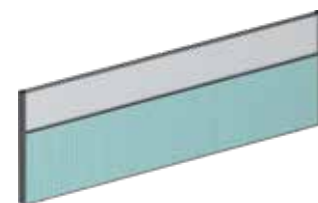
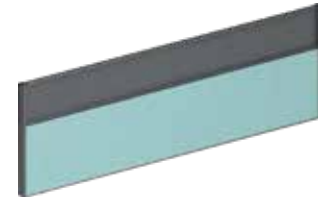

Code      Where used      W      Price

**380mm High Magnetic Dry Wipe Board**

Price is per side and additional to fabric screen. Specify screen base code with suffix:

-DB	2030	1998 wide screen	£110
-DB	2000	1968 wide screen	£109
-DB	1800	1768 wide screen	£99
-DB	1630	1598 wide screen	£91
-DB	1600	1568 wide screen	£89
-DB	1400	1368 wide screen	£78
-DB	1200	1168 wide screen	£67
-DB	1000	968 wide screen	£56
-DB	800	768 wide screen	£46
-DB	600	568 wide screen	£41



**480mm High Magnetic Dry Wipe Board**

Price is per side and additional to fabric screen. Specify screen base code with suffix:

-DB	2030	1998 wide screen	£140
-DB	2000	1968 wide screen	£138
-DB	1800	1768 wide screen	£125
-DB	1630	1598 wide screen	£114
-DB	1600	1568 wide screen	£111
-DB	1400	1368 wide screen	£100
-DB	1200	1168 wide screen	£85
-DB	1000	1968 wide screen	£69
-DB	800	768 wide screen	£56
-DB	600	568 wide screen	£46



Wave Fabric Desk Mounted Screens

# GOF DESK MOUNTED SCREENS & PODS

5 Year  
Guarantee

Perforated steel screens can be colour co-ordinated to match adjacent desk steelwork. They offer privacy with partial light transfer.

- Available in straight and wave-topped options.
- Can accept magnetic accessories / stationery.
- Aluminium frame includes integral tool-bar to top edge.



Code	Where used	W	D	H	Price
------	------------	---	---	---	-------

### 280mm High Straight Perforated Steel

VSDS213	2030	1998	x 30	x 280	£377
VSDS203	2000	1968	x 30	x 280	£374
VSDS183	1800	1768	x 30	x 280	£316
VSDS173	1630	1598	x 30	x 280	£307
VSDS163	1600	1568	x 30	x 280	£300
VSDS143	1400	1368	x 30	x 280	£282
VSDS123	1200	1168	x 30	x 280	£262
VSDS103	1000	968	x 30	x 280	£241
VSDS083	800	768	x 30	x 280	£225
VSDS063	600	568	x 30	x 280	£205



### 380mm High Straight Perforated Steel

VSDS214	2030	1998	x 30	x 380	£440
VSDS204	2000	1968	x 30	x 380	£436
VSDS184	1800	1768	x 30	x 380	£367
VSDS174	1630	1598	x 30	x 380	£346
VSDS164	1600	1568	x 30	x 380	£339
VSDS144	1400	1368	x 30	x 380	£320
VSDS124	1200	1168	x 30	x 380	£285
VSDS104	1000	968	x 30	x 380	£270
VSDS084	800	768	x 30	x 380	£254
VSDS064	600	568	x 30	x 380	£231



### 480mm High Straight Perforated Steel

VSDS215	2030	1998	x 30	x 480	£490
VSDS205	2000	1968	x 30	x 480	£488
VSDS185	1800	1768	x 30	x 480	£407
VSDS175	1630	1598	x 30	x 480	£381
VSDS165	1600	1568	x 30	x 480	£379
VSDS145	1400	1368	x 30	x 480	£362
VSDS125	1200	1168	x 30	x 480	£330
VSDS105	1000	968	x 30	x 480	£301
VSDS085	800	768	x 30	x 480	£271
VSDS065	600	568	x 30	x 480	£253



### 380/180mm High Wave Perforated Steel

VSDS214W	2030	1998	x 30	x 380/180	£514
VSDS204W	2000	1968	x 30	x 380/180	£512
VSDS184W	1800	1768	x 30	x 380/180	£428
VSDS174W	1630	1598	x 30	x 380/180	£419
VSDS164W	1600	1568	x 30	x 380/180	£410
VSDS144W	1400	1368	x 30	x 380/180	£405
VSDS124W	1200	1168	x 30	x 380/180	£381
VSDS104W	1000	968	x 30	x 380/180	£371
VSDS084W	800	768	x 30	x 380/180	£323



### 480/280mm High Wave Perforated Steel

VSDS215W	2030	1998	x 300	x 480/280	£568
VSDS205W	2000	1968	x 300	x 480/280	£562
VSDS185W	1800	1768	x 30	x 480/280	£462
VSDS175W	1630	1598	x 30	x 480/280	£444
VSDS165W	1600	1568	x 30	x 480/280	£443
VSDS145W	1400	1368	x 30	x 480/280	£427
VSDS125W	1200	1168	x 30	x 480/280	£401
VSDS105W	1000	968	x 30	x 480/280	£377
VSDS085W	800	768	x 30	x 480/280	£341



5 Year  
Guarantee

## GOF DESK MOUNTED SCREENS & PODS



Screens & Pods

Wave Perforated Steel Desk Mounted Screens

# GOF DESK MOUNTED SCREENS & PODS

5 Year  
Guarantee

Acrylic screens can have their frame colours co-ordinated to match adjacent desk steelwork. They offer privacy with nearly full light transfer.

- Available in straight or wave-topped options.
- Aluminium frame includes integral tool-bar to top edge.
- Acrylic available in clear, frosted or a selection of colours - Specify at point of order.

## Acrylic Options



S2 000 S2 030  
Clear Polar Frost

## Coloured Frosted Acrylic Options - Surcharge

(More colours available, see Technical Information section).



S2 9T21 S2 4T50 S2 2T07 S2 7T1F S2 3T17 S2 6T21 S2 6T9A  
Stone Chilli Red Citrus Azure Blue Mandarin Glacier Lime Zest  
Grey Red Yellow Blue Orange Green Zest



Code	Where used	W	D	H	Clear or Frosted	Colours Surcharge
<b>280mm High Straight Acrylic</b>						
VSDA213	2030	1998	x 30	x 280	£278	£33
VSDA203	2000	1968	x 30	x 280	£277	£33
VSDA183	1800	1768	x 30	x 280	£262	£33
VSDA173	1630	1598	x 30	x 280	£252	£33
VSDA163	1600	1568	x 30	x 280	£241	£33
VSDA143	1400	1368	x 30	x 280	£225	£33
VSDA123	1200	1168	x 30	x 280	£202	£33
VSDA103	1000	968	x 30	x 280	£186	£33
VSDA083	800	768	x 30	x 280	£163	£33
VSDA063	600	568	x 30	x 280	£145	£33

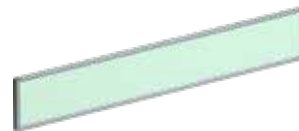

<b>380mm High Straight Acrylic</b>						
VSDA214	2030	1998	x 30	x 380	£323	£47
VSDA204	2000	1968	x 30	x 380	£322	£47
VSDA184	1800	1768	x 30	x 380	£307	£47
VSDA174	1630	1598	x 30	x 380	£287	£47
VSDA164	1600	1568	x 30	x 380	£282	£47
VSDA144	1400	1368	x 30	x 380	£261	£47
VSDA124	1200	1168	x 30	x 380	£235	£47
VSDA104	1000	968	x 30	x 380	£211	£47
VSDA084	800	768	x 30	x 380	£192	£47
VSDA064	600	568	x 30	x 380	£169	£47



<b>480mm High Straight Acrylic</b>						
VSDA215	2030	1998	x 30	x 480	£371	£64
VSDA205	2000	1968	x 30	x 480	£369	£64
VSDA185	1800	1768	x 30	x 480	£352	£64
VSDA175	1630	1598	x 30	x 480	£328	£64
VSDA165	1600	1568	x 30	x 480	£323	£64
VSDA145	1400	1368	x 30	x 480	£293	£64
VSDA125	1200	1168	x 30	x 480	£266	£64
VSDA105	1000	968	x 30	x 480	£237	£64
VSDA085	800	768	x 30	x 480	£209	£64
VSDA065	600	568	x 30	x 480	£193	£64

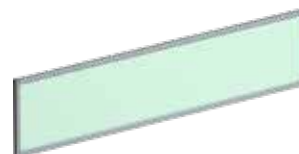

<b>380/180mm High Wave Acrylic</b>						
VSDA214W	2030	1998	x 30	x 380/180	£561	£47
VSDA204W	2000	1968	x 30	x 380/180	£558	£47
VSDA184W	1800	1768	x 30	x 380/180	£542	£47
VSDA174W	1630	1598	x 30	x 380/180	£530	£47
VSDA164W	1600	1568	x 30	x 380/180	£529	£47
VSDA144W	1400	1368	x 30	x 380/180	£514	£47
VSDA124W	1200	1168	x 30	x 380/180	£489	£47
VSDA104W	1000	968	x 30	x 380/180	£474	£47
VSDA084W	800	768	x 30	x 380/180	£447	£47



<b>480/280mm High Wave Acrylic</b>						
VSDA215W	2030	1998	x 30	x 480/280	£600	£64
VSDA205W	2000	1968	x 30	x 480/280	£594	£64
VSDA185W	1800	1768	x 30	x 480/280	£579	£64
VSDA175W	1630	1598	x 30	x 480/280	£562	£64
VSDA165W	1600	1568	x 30	x 480/280	£561	£64
VSDA145W	1400	1368	x 30	x 480/280	£542	£64
VSDA125W	1200	1168	x 30	x 480/280	£516	£64
VSDA105W	1000	968	x 30	x 480/280	£494	£64
VSDA085W	800	768	x 30	x 480/280	£463	£64

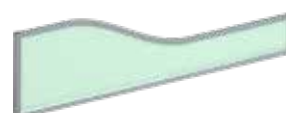



5 Year  
Guarantee

## GOF DESK MOUNTED SCREENS & PODS



Screens & Pods

Straight Acrylic Desk Mounted Screens

# GOF DESK MOUNTED SCREENS & PODS

## FIXING BRACKETS



Desk Mounted Screens fit all Gresham desk ranges and are inclusive of brackets. When ordering, suffix the screen code with bracket type.



### How to specify -

- 1: Identify desk range
- 2: Select screen position (see diagrams)
- 3: Identify screen length & type
- 4: Add bracket suffix to screen code

Example of use -

1 1600 Deskkit Workstation rear screen VSDf164-20

Screens & Pods

### Bench<sup>2</sup> Access Top \* Requires link post

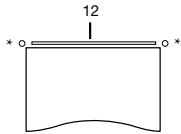

### Bench<sup>2</sup> Scallop Top & DesQ \* Requires link post If used with Bench<sup>2</sup> over desk shelving, please substitute -04 brackets with -14

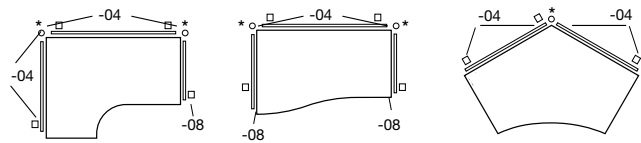

\* Requires User Modification

### Bench<sup>2</sup> Fixed Top \* Requires link post

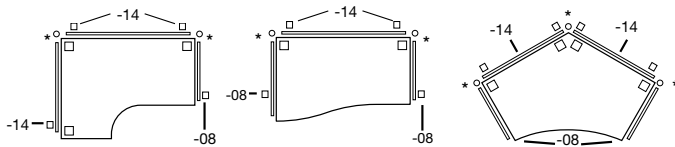

### Mesa \* Requires link post

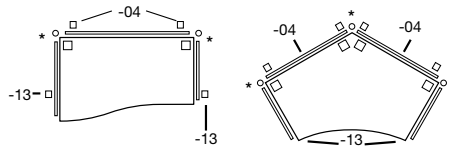

\* Requires User Modification

### EX10 Executive \* Requires link post

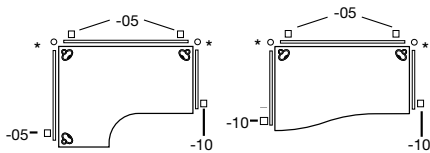

### Deskkit \* Requires link post

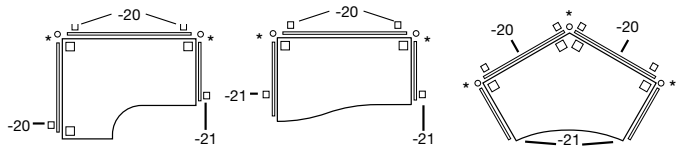

### Desktop Screen Brackets

- 04 Mesa, Bench Scallop & DesQ configurations (supplied in pairs).
- 05 EX10 Executive configurations - Fits to port holes (supplied in pairs).
- 08 Bench<sup>2</sup> Fixed, Scallop Top & DesQ configurations - 1000 side - 800 sides (supplied singularly) - Jaw size 17mm - 32mm.
- 10 Can be used on any range (supplied singularly)
- 12 Bench<sup>2</sup> Access Top screen support rail - singular.
- 13 Mesa & Mesa Plus - 800 side & 600 return sides - (supplied singularly).
- 14 Bench<sup>2</sup> Fixed Top brackets - supplied in pairs.
- 20 Deskkit configurations (supplied in pairs) - Jaw size 15mm - 30mm.
- 21 Deskkit configurations - 1000, 800 & 600 Return screen for use on 25mm thick tops. Can only be used with rear screen and 4way post

### Bracket Suffix Codes

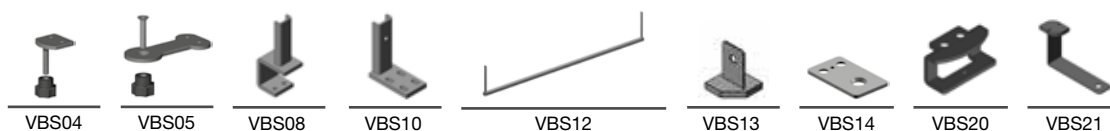

Code	Description	Price
<b>4 Way Link Post Set</b>		
VLP05	480mm high 4 way 90° linking set	£62
VLP04	380mm high 4 way 90° linking set	£60
VLP03	280mm high 4 way 90° linking set	£56
VLP02	180mm high 4 way 90° linking set	£50

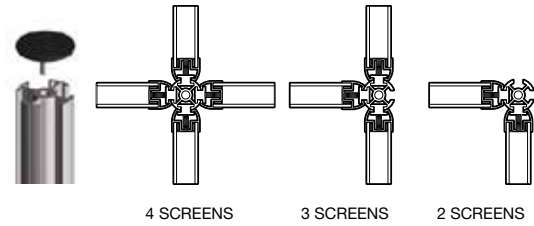

<b>3 Way Link Post Set</b>		
VLP05-3	480mm high 3 way 120° linking set	£62
VLP04-3	380mm high 3 way 120° linking set	£60
VLP03-3	280mm high 3 way 120° linking set	£56
VLP02-3	180mm high 3 way 120° linking set	£50

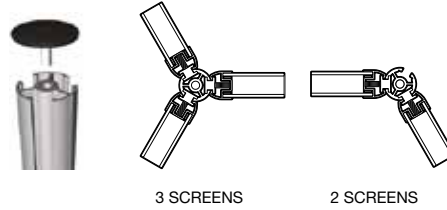

**Link Infill Sets**

Only required when linking floor standing to desk mounted screens on Deskit, EX10 Executive, Bench<sup>2</sup>, Mesa and Mesa Plus.  
Example of link infill usage.

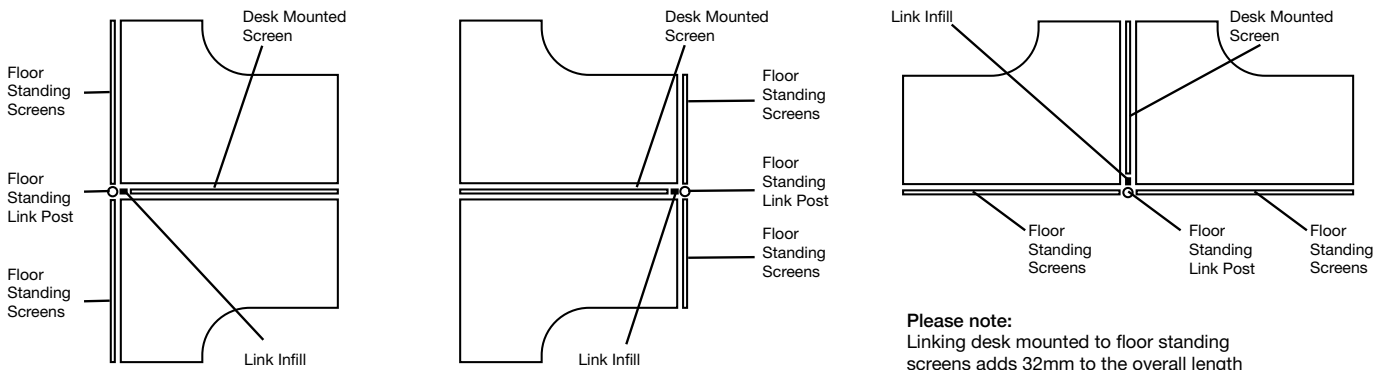

**Desktop Screen to Floor Standing Screen Link infills**

Code	Description	Price
VL103	280mm high link infill	£37
VL104	380mm high link infill	£37
VL105	480mm high link infill	£37



**Screen to desk link bracket**

Code	Description	Price
UNDSL	Links desks to floor standing screens	£16



# GOF FLOOR STANDING SCREENS & PODS

5 Year  
Guarantee

Floor standing screens match the construction and can be linked to desk mounted screens. They can be used to divide space in open plan areas.



- Available in straight and wave-topped options.
- Available in a selection of heights and widths.
- Aluminium frame includes integral tool-bar to top edge.
- Certain configurations may require link posts & stabiliser feet.

Screens & Pods

Code	W	D	H	Band 1	Band 2	Band 3
<b>1000mm High Straight Fabric</b>						
VSF1810	1800	x 30	x 1000	£446	£484	£541
VSF1710	1630	x 30	x 1000	£361	£379	£441
VSF1610	1600	x 30	x 1000	£355	£378	£440
VSF1410	1400	x 30	x 1000	£332	£361	£403
VSF1210	1200	x 30	x 1000	£315	£339	£380
VSF1010	1000	x 30	x 1000	£293	£319	£363
VSF0810	800	x 30	x 1000	£254	£266	£291
VSF0610	600	x 30	x 1000	£235	£261	£285



<b>1100mm High Straight Fabric</b>						
VSF1811	1800	x 30	x 1100	£464	£496	£557
VSF1711	1630	x 30	x 1100	£379	£407	£465
VSF1611	1600	x 30	x 1100	£378	£404	£463
VSF1411	1400	x 30	x 1100	£361	£379	£424
VSF1211	1200	x 30	x 1100	£333	£362	£404
VSF1011	1000	x 30	x 1100	£318	£341	£381
VSF0811	800	x 30	x 1100	£265	£281	£310
VSF0611	600	x 30	x 1100	£241	£270	£293



<b>1200mm High Straight Fabric</b> Additional toolbar at 1000mm high.						
VSF1812	1800	x 30	x 1200	£533	£573	£632
VSF1712	1630	x 30	x 1200	£492	£514	£575
VSF1612	1600	x 30	x 1200	£489	£512	£573
VSF1412	1400	x 30	x 1200	£457	£482	£526
VSF1212	1200	x 30	x 1200	£428	£452	£495
VSF1012	1000	x 30	x 1200	£403	£425	£466
VSF0812	800	x 30	x 1200	£315	£330	£356
VSF0612	600	x 30	x 1200	£282	£310	£333



<b>1400mm High Straight Fabric</b> Additional toolbar at 1000mm high.						
VSF1814	1800	x 30	x 1400	£563	£601	£660
VSF1714	1630	x 30	x 1400	£516	£545	£606
VSF1614	1600	x 30	x 1400	£512	£540	£601
VSF1414	1400	x 30	x 1400	£482	£512	£555
VSF1214	1200	x 30	x 1400	£448	£479	£522
VSF1014	1000	x 30	x 1400	£419	£448	£492
VSF0814	800	x 30	x 1400	£342	£362	£384
VSF0614	600	x 30	x 1400	£316	£341	£368



<b>1600mm High Straight Fabric</b> Additional toolbar at 1000mm high.						
VSF1816	1800	x 30	x 1600	£591	£627	£686
VSF1716	1630	x 30	x 1600	£568	£601	£660
VSF1616	1600	x 30	x 1600	£561	£594	£657
VSF1416	1400	x 30	x 1600	£529	£562	£606
VSF1216	1200	x 30	x 1600	£494	£529	£573
VSF1016	1000	x 30	x 1600	£463	£496	£540
VSF0816	800	x 30	x 1600	£369	£386	£413
VSF0616	600	x 30	x 1600	£339	£363	£386



<b>1800mm High Straight Fabric</b> Additional toolbar at 1000mm high.						
VSF1818	1800	x 30	x 1800	£652	£688	£750
VSF1718	1630	x 30	x 1800	£622	£659	£720
VSF1618	1600	x 30	x 1800	£619	£654	£714
VSF1418	1400	x 30	x 1800	£580	£619	£660
VSF1218	1200	x 30	x 1800	£541	£575	£619
VSF1018	1000	x 30	x 1800	£510	£540	£584
VSF0818	800	x 30	x 1800	£405	£427	£454
VSF0618	600	x 30	x 1800	£372	£390	£418



5 Year  
Guarantee

## GOF FLOOR STANDING SCREENS & PODS



Screens & Pods

1600mm High Straight Fabric Floor Standing Screens

# GOF FLOOR STANDING SCREENS & PODS

5 Year  
Guarantee

Floor standing screens are available in a selection of fabric finishes or can be specified in a combination of materials that suit user preferences.

- Available in a selection of heights and widths.
- Available in straight or wave-topped options.
- Aluminium frame includes integral tool-bar to top edge.
- Acrylic available in clear, frosted or a selection of colours - Specify at point of order.
- Certain configurations may require link posts & stabiliser feet.

## Acrylic Options



S2 000 S2 030  
Clear Polar Frost

## Coloured Frosted Acrylic Options - Surcharge

(More colours available, see Technical Information section).



S2 9T21 S2 4T50 S2 2T07 S2 7T1F S2 3T17 S2 6T21 S2 6T9A  
Stone Chilli Citrus Azure Mandarin Glacier Lime  
Grey Red Yellow Blue Orange Green Zest



### 1400mm High Part Glazed Straight Fabric/Acrylic

Additional toolbar at 1000mm high.

Code	W	D	H
VSA1814	1800	x 30	x 1400
VSA1714	1630	x 30	x 1400
VSA1614	1600	x 30	x 1400
VSA1414	1400	x 30	x 1400
VSA1214	1200	x 30	x 1400
VSA1014	1000	x 30	x 1400
VSA0814	800	x 30	x 1400
VSA0614	600	x 30	x 1400

Band 1	Band 2	Band 3	Colour Surcharge
£724	£767	£831	£47
£621	£650	£707	£47
£619	£644	£705	£47
£588	£613	£658	£47
£561	£585	£628	£47
£462	£489	£531	£47
£407	£424	£448	£47
£352	£371	£396	£47



### 1600mm High Part Glazed Straight Fabric/Acrylic

Additional toolbar at 1000mm high.

VSA1816	1800	x 30	x 1600
VSA1716	1630	x 30	x 1600
VSA1616	1600	x 30	x 1600
VSA1416	1400	x 30	x 1600
VSA1216	1200	x 30	x 1600
VSA1016	1000	x 30	x 1600
VSA0816	800	x 30	x 1600
VSA0616	600	x 30	x 1600

£821	£864	£923	£64
£718	£746	£805	£64
£714	£745	£803	£64
£665	£712	£756	£64
£612	£684	£725	£64
£514	£541	£585	£64
£463	£494	£520	£64
£410	£441	£465	£64



### 1800mm High Part Glazed Straight Fabric/Acrylic

Additional toolbar at 1000mm high.

VSA1818	1800	x 30	x 1800
VSA1718	1630	x 30	x 1800
VSA1618	1600	x 30	x 1800
VSA1418	1400	x 30	x 1800
VSA1218	1200	x 30	x 1800
VSA1018	1000	x 30	x 1800
VSA0818	800	x 30	x 1800
VSA0618	600	x 30	x 1800

£921	£947	£1,012	£79
£792	£819	£877	£79
£790	£817	£876	£79
£741	£784	£826	£79
£665	£751	£792	£79
£568	£595	£638	£79
£518	£541	£570	£79
£451	£486	£512	£79



### 1400mm High Straight Fabric/Perforated Steel

Additional toolbar at 1000mm high

VSS1814	1800	x 30	x 1400
VSS1714	1630	x 30	x 1400
VSS1614	1600	x 30	x 1400
VSS1414	1400	x 30	x 1400
VSS1214	1200	x 30	x 1400
VSS1014	1000	x 30	x 1400
VSS0814	800	x 30	x 1400
VSS0614	600	x 30	x 1400

£697	£760	£819	-
£584	£610	£670	-
£576	£604	£665	-
£534	£563	£608	-
£497	£529	£573	-
£463	£490	£532	-
£352	£369	£394	-
£316	£328	£355	-



### 1600mm High Straight Fabric/Perforated Steel

Additional toolbar at 1000mm high

VSS1816	1800	x 30	x 1600
VSS1716	1630	x 30	x 1600
VSS1616	1600	x 30	x 1600
VSS1416	1400	x 30	x 1600
VSS1216	1200	x 30	x 1600
VSS1016	1000	x 30	x 1600
VSS0816	800	x 30	x 1600
VSS0616	600	x 30	x 1600

£751	£789	£846	-
£633	£660	£721	-
£627	£653	£712	-
£584	£610	£654	-
£540	£570	£610	-
£492	£516	£558	-
£414	£432	£458	-
£369	£380	£409	-

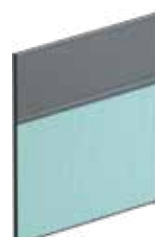

5 Year  
Guarantee

# GOF FLOOR STANDING SCREENS & PODS



**Code                      W                      H**

**1800mm High Mobile Screens Fabric**

VSFM1618	1600	x	1800
VSFM1418	1400	x	1800
VSFM1218	1200	x	1800

Band 1	Band 2	Band 3
£784	£826	£912
£776	£817	£861
£746	£787	£831

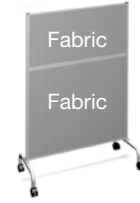

**1800mm High Mobile Screens Fabric/MFC Wooden Panel**

VSFMW1618	1600	x	1800
VSFMW1418	1400	x	1800
VSFMW1218	1200	x	1800

£826	£850	£933
£817	£842	£887
£787	£811	£856



Screens & Pods



1600mm High Straight Part Glazed Floor Standing Screens

# GOF FLOOR STANDING SCREENS & PODS

5 Year  
Guarantee

Floor standing screens match the construction and can be linked to desk mounted screens. They can be used to divide space in open plan areas.



- Available in straight and wave-topped options.
- Available in a selection of heights and widths.
- Aluminium frame includes integral tool-bar to top edge.
- Certain configurations may require link posts & stabiliser feet.

Screens & Pods

Code	W	D	H	Band 1	Band 2	Band 3		
<b>1100/900mm High Wave Fabric</b>								
VSF1811W	1800	x	30	x	1100/900	£495	£532	£593
VSF1711W	1630	x	30	x	1100/900	£452	£478	£534
VSF1611W	1600	x	30	x	1100/900	£448	£473	£532
VSF1411W	1400	x	30	x	1100/900	£438	£464	£507
VSF1211W	1200	x	30	x	1100/900	£411	£438	£482
VSF1011W	1000	x	30	x	1100/900	£401	£424	£465
VSF0811W	800	x	30	x	1100/900	£353	£371	£396
<b>1200/1000mm High Wave Fabric</b>								
VSF1812W	1800	x	30	x	1200/1000	£516	£556	£618
VSF1712W	1630	x	30	x	1200/1000	£469	£497	£558
VSF1612W	1600	x	30	x	1200/1000	£466	£496	£557
VSF1412W	1400	x	30	x	1200/1000	£454	£484	£527
VSF1212W	1200	x	30	x	1200/1000	£432	£462	£504
VSF1012W	1000	x	30	x	1200/1000	£414	£444	£488
VSF0812W	800	x	30	x	1200/1000	£367	£405	£428
<b>1400/1200mm High Wave Fabric</b> Additional toolbar at 1000mm high.								
VSF1814W	1800	x	30	x	1400/1200	£604	£641	£703
VSF1714W	1630	x	30	x	1400/1200	£571	£601	£660
VSF1614W	1600	x	30	x	1400/1200	£568	£595	£658
VSF1414W	1400	x	30	x	1400/1200	£540	£573	£613
VSF1214W	1200	x	30	x	1400/1200	£507	£534	£579
VSF1014W	1000	x	30	x	1400/1200	£492	£520	£562
VSF0814W	800	x	30	x	1400/1200	£410	£428	£457
<b>1600/1400mm High Wave Fabric</b> Additional toolbar at 1000mm high.								
VSF1816W	1800	x	30	x	1600/1400	£630	£666	£725
VSF1716W	1630	x	30	x	1600/1400	£612	£646	£706
VSF1616W	1600	x	30	x	1600/1400	£606	£641	£703
VSF1416W	1400	x	30	x	1600/1400	£580	£613	£658
VSF1216W	1200	x	30	x	1600/1400	£545	£579	£622
VSF1016W	1000	x	30	x	1600/1400	£516	£554	£594
VSF0816W	800	x	30	x	1600/1400	£411	£438	£463
<b>1800/1600mm High Wave Fabric</b> Additional toolbar at 1000mm high.								
VSF1818W	1800	x	30	x	1800/1600	£692	£734	£794
VSF1718W	1630	x	30	x	1800/1600	£674	£714	£771
VSF1618W	1600	x	30	x	1800/1600	£666	£706	£766
VSF1418W	1400	x	30	x	1800/1600	£637	£678	£723
VSF1218W	1200	x	30	x	1800/1600	£601	£635	£677
VSF1018W	1000	x	30	x	1800/1600	£571	£602	£644
VSF0818W	800	x	30	x	1800/1600	£562	£588	£612





Code            W            D            H

**1400/1200mm High Part Glazed Wave Fabric/Acrylic**  
Additional toolbar at 1000mm high.

VSA1814W	1800	x	30	x	1400/1200
VSA1714W	1630	x	30	x	1400/1200
VSA1614W	1600	x	30	x	1400/1200
VSA1414W	1400	x	30	x	1400/1200
VSA1214W	1200	x	30	x	1400/1200
VSA1014W	1000	x	30	x	1400/1200
VSA0814W	800	x	30	x	1400/1200

**1600/1400mm High Part Glazed Wave Fabric/Acrylic**  
Additional toolbar at 1000mm high.

VSA1816W	1800	x	30	x	1600/1400
VSA1716W	1630	x	30	x	1600/1400
VSA1616W	1600	x	30	x	1600/1400
VSA1416W	1400	x	30	x	1600/1400
VSA1216W	1200	x	30	x	1600/1400
VSA1016W	1000	x	30	x	1600/1400
VSA0816W	800	x	30	x	1600/1400

**1800/1600mm High Part Glazed Wave Fabric/Acrylic**  
Additional toolbar at 1000mm high.

VSA1818W	1800	x	30	x	1800/1600
VSA1718W	1630	x	30	x	1800/1600
VSA1618W	1600	x	30	x	1800/1600
VSA1418W	1400	x	30	x	1800/1600
VSA1218W	1200	x	30	x	1800/1600
VSA1018W	1000	x	30	x	1800/1600
VSA0818W	800	x	30	x	1800/1600

**1400/1200mm High Part Wave Fabric/Perforated Steel**  
Additional toolbar at 1000mm high.

VSS1814W	1800	x	30	x	1400/1200
VSS1714W	1630	x	30	x	1400/1200
VSS1614W	1600	x	30	x	1400/1200
VSS1414W	1400	x	30	x	1400/1200
VSS1214W	1200	x	30	x	1400/1200
VSS1014W	1000	x	30	x	1400/1200
VSS0814W	800	x	30	x	1400/1200

**1600/1400mm High Part Wave Fabric/Perforated Steel**  
Additional toolbar at 1000mm high.

VSS1816W	1800	x	30	x	1600/1400
VSS1716W	1630	x	30	x	1600/1400
VSS1616W	1600	x	30	x	1600/1400
VSS1416W	1400	x	30	x	1600/1400
VSS1216W	1200	x	30	x	1600/1400
VSS1016W	1000	x	30	x	1600/1400
VSS0816W	800	x	30	x	1600/1400

Band 1	Band 2	Band 3	Colour Surcharge
£794	£834	£895	£47
£703	£724	£786	£47
£696	£721	£784	£47
£674	£703	£746	£47
£641	£667	£710	£47
£556	£580	£625	£47
£496	£513	£538	£47

£884	£910	£970	£64
£792	£819	£877	£64
£788	£816	£875	£64
£781	£792	£835	£64
£735	£764	£806	£64
£606	£635	£677	£64
£554	£591	£619	£64

£970	£1,027	£1,088	£79
£873	£925	£983	£79
£868	£921	£978	£79
£859	£906	£951	£79
£809	£860	£900	£79
£666	£706	£751	£79
£606	£644	£670	£79

£769	£811	£873	-
£671	£697	£758	-
£666	£694	£754	-
£633	£660	£704	-
£593	£620	£664	-
£562	£588	£630	-
£494	£510	£533	-

£828	£869	£930	-
£721	£750	£809	-
£714	£745	£803	-
£680	£707	£752	-
£635	£664	£705	-
£600	£627	£669	-
£562	£588	£613	-



# MIRAGE TREES SCREENS & PODS



Inspired by the surrounding nature, our class A sound absorbing tree shaped panelled screens are perfect for any environment. When put together, the panels take on the shape of a forest: made even more realistic and evocative by the fact that the panels can be chosen in the typical colours of the leaves in spring, summer and autumn. Putting several panels together allows them to be used as a partition wall, to divide up - even on a temporary basis - work areas or dining areas, or to create genuinely private spaces in order to create small lounges or meeting rooms. Featuring an elegant design, a highly practical dividing function.

## Product Features



## Colour Options



Please Note:  
TRE03 and TRE04 are only available in Inloom Sealife 6075 Fabric.

Screens & Pods



**TRE01**  
Small Mirage Tree Screen

Height ..... 1260mm  
Width ..... 990mm  
Depth ..... 295mm  
Weight ..... 8.0kg  
Price ..... £963



**TRE02**  
Large Mirage Tree Screen

Height ..... 1660mm  
Width ..... 990mm  
Depth ..... 295mm  
Weight ..... 9.5kg  
Price ..... £1,071



**TRE03**  
Small Mirage Tree Screen  
(Made from Recycled Bottles)

Height ..... 1260mm  
Width ..... 990mm  
Depth ..... 295mm  
Weight ..... 8.0kg  
Price ..... £959



**TRE04**  
Large Mirage Tree Screen  
(Made from Recycled Bottles)

Height ..... 1660mm  
Width ..... 990mm  
Depth ..... 295mm  
Weight ..... 9.5kg  
Price ..... £1,063



5 Year  
Guarantee

NEW  
PRODUCT

# MIRAGE TREES SCREENS & PODS

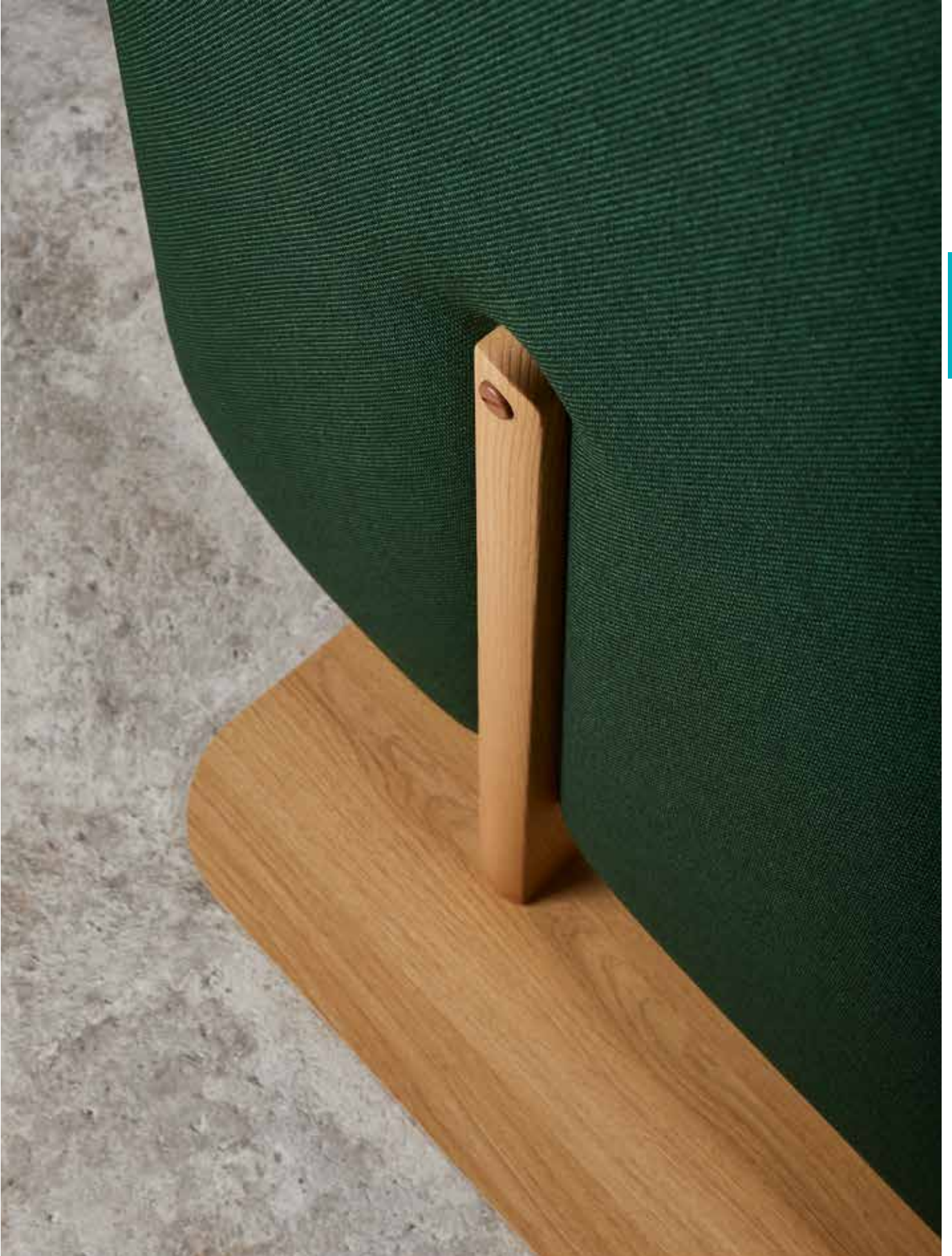

Screens & Pods

# GOF PANELS SCREENS & PODS

5 Year  
Guarantee

Code	Where used	Price
------	------------	-------

### 1400mm Magnetic Dry Wipe Board

Fits into upper section of screen only, price is per side and additional to fabric screen, specify screen code with suffix.

-DB	To suit 1800 wide screens	£150
-DB	To suit 1630 wide screens	£140
-DB	To suit 1600 wide screens	£138
-DB	To suit 1400 wide screens	£118
-DB	To suit 1200 wide screens	£102
-DB	To suit 1000 wide screens	£82
-DB	To suit 800 wide screens	£56
-DB	To suit 600 wide screens	£50

Magnetic dry  
wipe board (-DB)

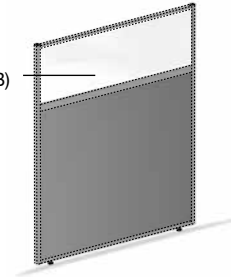

### 1600mm Magnetic Dry Wipe Board

Fits into upper section of screen only, price is per side and additional to fabric screen, specify screen code with suffix.

-DB	To suit 1800 wide screens	£211
-DB	To suit 1630 wide screens	£193
-DB	To suit 1600 wide screens	£188
-DB	To suit 1400 wide screens	£164
-DB	To suit 1200 wide screens	£145
-DB	To suit 1000 wide screens	£112
-DB	To suit 800 wide screens	£97
-DB	To suit 600 wide screens	£92

### 1800mm Magnetic Dry Wipe Board

Fits into upper section of screen only, price is per side and additional to fabric screen, specify screen code with suffix.

-DB	To suit 1800 wide screens	£300
-DB	To suit 1630 wide screens	£269
-DB	To suit 1600 wide screens	£261
-DB	To suit 1400 wide screens	£229
-DB	To suit 1200 wide screens	£202
-DB	To suit 1000 wide screens	£162
-DB	To suit 800 wide screens	£137
-DB	To suit 600 wide screens	£125

### Steel Kick Plate

Price is per side and additional to fabric.

VSKP18	To suit 1800 wide screens	£56
VSKP17	To suit 1630 wide screens	£54
VSKP16	To suit 1600 wide screens	£54
VSKP14	To suit 1400 wide screens	£50
VSKP12	To suit 1200 wide screens	£46
VSKP10	To suit 1000 wide screens	£44
VSKP08	To suit 800 wide screens	£42
VSKP06	To suit 600 wide screens	£41

Steel kick plate

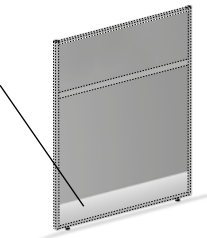

5 Year  
Guarantee

## GOF PANELS SCREENS & PODS



Screens & Pods

1400mm High Straight Fabric Floor Standing Screens with Magnetic Dry Wipe Board

# GOF GOAL POST SCREENS & PODS

5 Year  
Guarantee

Goal Post screens offer the advantages of standard floor standing screens whilst providing easy cable pass through from desk to desk beneath the worksurface.



- Available in a selection of heights and widths.
- Available in straight or wave-topped options.
- Can be linked directly to full panelled versions.
- Open section is 610mm high.

Screens & Pods

Code	W	D	H	Band 1	Band 2	Band 3		
<b>1000mm High Straight Fabric</b>								
VSG1810	1800	x	30	x	1000	£333	£363	£421
VSG1710	1630	x	30	x	1000	£270	£289	£350
VSG1610	1600	x	30	x	1000	£266	£285	£346
VSG1410	1400	x	30	x	1000	£254	£270	£314
VSG1210	1200	x	30	x	1000	£235	£257	£300
VSG1010	1000	x	30	x	1000	£223	£237	£278
VSG0810	800	x	30	x	1000	£192	£201	£227
VSG0610	600	x	30	x	1000	£177	£188	£212
<b>1100mm High Straight Fabric</b>								
VSG1811	1800	x	30	x	1100	£346	£374	£434
VSG1711	1630	x	30	x	1100	£289	£307	£368
VSG1611	1600	x	30	x	1100	£285	£301	£363
VSG1411	1400	x	30	x	1100	£270	£289	£332
VSG1211	1200	x	30	x	1100	£256	£271	£315
VSG1011	1000	x	30	x	1100	£236	£257	£300
VSG0811	800	x	30	x	1100	£201	£209	£235
VSG0611	600	x	30	x	1100	£179	£193	£218
<b>1200mm High Straight Fabric</b>								
VSG1812	1800	x	30	x	1200	£404	£428	£490
VSG1712	1630	x	30	x	1200	£371	£386	£447
VSG1612	1600	x	30	x	1200	£367	£381	£444
VSG1412	1400	x	30	x	1200	£342	£362	£404
VSG1212	1200	x	30	x	1200	£322	£341	£381
VSG1012	1000	x	30	x	1200	£300	£320	£366
VSG0812	800	x	30	x	1200	£256	£270	£293
VSG0612	600	x	30	x	1200	£236	£253	£274
<b>1400mm High Straight Fabric</b>								
VSG1814	1800	x	30	x	1400	£424	£451	£512
VSG1714	1630	x	30	x	1400	£386	£410	£469
VSG1614	1600	x	30	x	1400	£381	£407	£465
VSG1414	1400	x	30	x	1400	£363	£381	£426
VSG1214	1200	x	30	x	1400	£336	£362	£404
VSG1014	1000	x	30	x	1400	£316	£336	£379
VSG0814	800	x	30	x	1400	£258	£273	£318
VSG0614	600	x	30	x	1400	£237	£257	£281
<b>1600mm High Straight Fabric</b>								
VSG1816	1800	x	30	x	1600	£477	£500	£562
VSG1716	1630	x	30	x	1600	£454	£484	£541
VSG1616	1600	x	30	x	1600	£448	£482	£534
VSG1416	1400	x	30	x	1600	£424	£451	£494
VSG1216	1200	x	30	x	1600	£396	£424	£465
VSG1016	1000	x	30	x	1600	£372	£399	£441
VSG0816	800	x	30	x	1600	£298	£312	£353
VSG0616	600	x	30	x	1600	£274	£289	£316

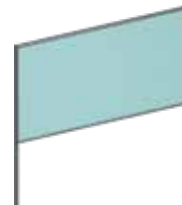
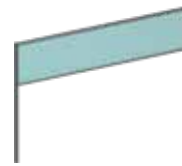

5 Year  
Guarantee

# GOF GOAL POST SCREENS & PODS

Code	W	D	H	Band 1	Band 2	Band 3
<b>1100/900mm High Wave Fabric</b>						
VSG1811W	1800	x 30	x 1100/900	£374	£403	£462
VSG1711W	1630	x 30	x 1100/900	£341	£357	£420
VSG1611W	1600	x 30	x 1100/900	£339	£356	£418
VSG1411W	1400	x 30	x 1100/900	£326	£350	£393
VSG1211W	1200	x 30	x 1100/900	£314	£326	£371
VSG1011W	1000	x 30	x 1100/900	£299	£319	£363
VSG0811W	800	x 30	x 1100/900	£266	£276	£304
<b>1200/1000mm High Wave Fabric</b>						
VSG1812W	1800	x 30	x 1200/1000	£389	£414	£477
VSG1712W	1630	x 30	x 1200/1000	£355	£376	£436
VSG1612W	1600	x 30	x 1200/1000	£353	£374	£432
VSG1412W	1400	x 30	x 1200/1000	£342	£363	£405
VSG1212W	1200	x 30	x 1200/1000	£323	£343	£386
VSG1012W	1000	x 30	x 1200/1000	£315	£332	£376
VSG0812W	800	x 30	x 1200/1000	£287	£318	£348
<b>1400/1200mm High Wave Fabric</b>						
VSG1814W	1800	x 30	x 1400/1200	£454	£484	£541
VSG1714W	1630	x 30	x 1400/1200	£427	£448	£510
VSG1614W	1600	x 30	x 1400/1200	£425	£446	£505
VSG1414W	1400	x 30	x 1400/1200	£407	£428	£473
VSG1214W	1200	x 30	x 1400/1200	£379	£405	£447
VSG1014W	1000	x 30	x 1400/1200	£371	£390	£434
VSG0814W	800	x 30	x 1400/1200	£310	£322	£348

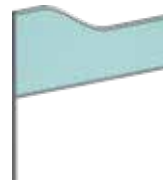
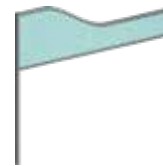
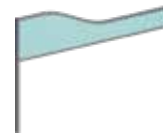

Screens & Pods



# GOF FLOOR STANDING SCREENS & PODS

## LINK POSTS & ACCESSORIES



Floor standing screens can be used to divide space in open plan areas. A selection of link posts and stabilising feet are available to aid stability.



- Screens can be linked together in straight lines as standard.
- Screens can be linked together at angles using link ports.
- Full, Half or Intermediate Feet can be specified where needed to avoid trip hazards.
- Available in colours matching screen metalwork.

Screens & Pods

### 4 Way Link Post Set - 90°

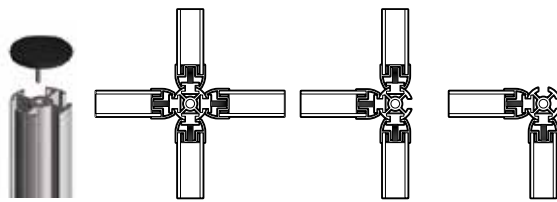

4 SCREENS      3 SCREENS      2 SCREENS

Code	For use with	Price
VLP18	1800mm high screen	£76
VLP16	1600mm high screen	£69
VLP14	1400mm high screen	£66
VLP12	1200mm high screen	£62
VLP11	1100mm high screen	£61
VLP10	1000mm high screen	£56

### 3 Way Link Post Set - 120°

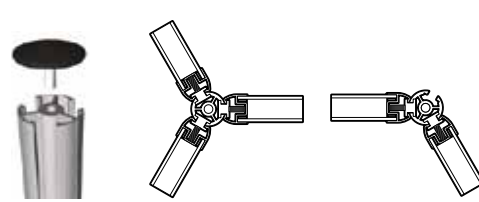

3 SCREENS      2 SCREENS

Code	For use with	Price
VLP18-3	1800mm high screen	£76
VLP16-3	1600mm high screen	£69
VLP14-3	1400mm high screen	£66
VLP12-3	1200mm high screen	£62
VLP11-3	1100mm high screen	£61
VLP10-3	1000mm high screen	£56

### Screen Stabiliser Feet

Code	Description	Price
VSFHR	Right hand half foot	£74
VSFHL	Left hand half foot	£74
VSFF	Full foot	£74
VSFI	Round intermediate foot	£74

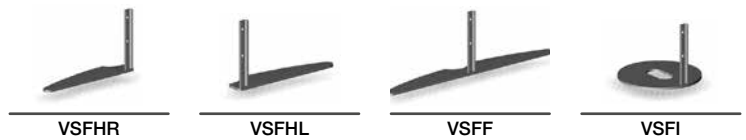

### Screen Infill Strips

Available in Black, Grey or White.

Code	For use with	Price
VIS18	1800mm high screen	£6
VIS16	1600mm high screen	£6
VIS14	1400mm high screen	£6
VIS12	1200mm high screen	£6
VIS11	1100mm high screen	£6
VIS10	1000mm high screen	£6

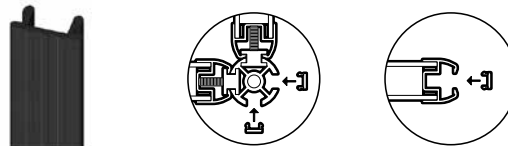

### A4 trays - For use with screen tool bar -

Available in Black or Silver.

A4 Landscape	A4 Portrait	A4 Stationery tray	Code	W	D	H	MFC Price
Code: VSTRA1 W: 395 D: 280 H: 62	Code: VSTRA2 W: 272 D: 350 H: 62	Code: VSTRA4 W: 388 D: 166 H: 95					
Price: £65	Price: £67	Price: £104					

### 3rd level shelving - 25mm MFC Shelf

Fits to floor standing screens



VSW084	800 x 260 x 400	£107
VSW064	600 x 260 x 400	£100
VSW082	800 x 260 x 200	£107
VSW062	600 x 260 x 200	£100





### Vision Panels - Fit to top of Straight Screens

Code	W	D	H	Price
------	---	---	---	-------

#### Wave Acrylic Vision Panel

Acrylic available in Clear or Frosted, specify at point of order.

VSGP12W	1200	x	5	x	400/200	£256
VSGP10W	1000	x	5	x	400/200	£236
VSGP08W	800	x	5	x	400/200	£209

#### Curved Acrylic Vision Panel

Acrylic available in Clear or Frosted, specify at point of order.

VSGP12C	1200	x	5	x	400/200	£256
VSGP10C	1000	x	5	x	400/200	£236
VSGP08C	800	x	5	x	400/200	£209



1600mm High Straight Part Glazed Floor Standing Screens

# MESA PLUS SCREENS & PODS

SCREENS &  
MODESTY PANELS

5 Year  
Guarantee

## Desk Mounted Screens (For Mesa Plus Desking only)



### Fabric & Acrylic

Please specify fabric and acrylic choice.

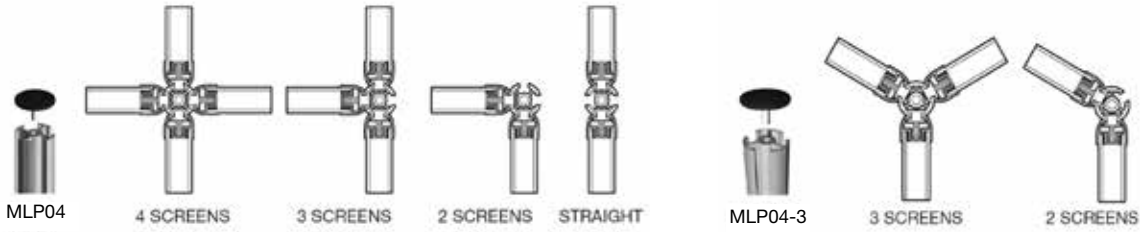

Screens & Pods

MLP04	4-Way Link Post Set	405mm high	£60
MLP04-3	3-Way Link Post Set	405mm high	£60

Code	Desk Size	W	D	H	Band 1	Band 2	Band 3
------	-----------	---	---	---	--------	--------	--------

### Fabric Covered

Inclusive of fixing brackets. Requires Link Post at Joints.  
Screens are 380h above desk.

MSDF204	2000	1968	30	405	£401	£420	£463
MSDF184	1800	1768	30	405	£362	£379	£424
MSDF164	1600	1568	30	405	£281	£298	£339
MSDF144	1400	1368	30	405	£237	£257	£300
MSDF124	1200	1168	30	405	£229	£246	£289
MSDF104	1000	968	30	405	£222	£235	£276
MSDF084	800	768	30	405	£202	£209	£254
MSRF084	800 Return Side	768	30	380	£202	£209	£254
MSRF064	600 Return Side	568	30	380	£195	£201	£241



### Acrylic

Inclusive of fixing brackets. Requires Link Post at Joints.  
Screens are 380h above desk.

Code	Desk Size	W	D	H	Clear or Frosted	Colours Surcharge
MSDA204	2000	1968	30	405	£322	£47
MSDA184	1800	1768	30	405	£307	£47
MSDA164	1600	1568	30	405	£282	£47
MSDA144	1400	1368	30	405	£261	£47
MSDA124	1200	1168	30	405	£235	£47
MSDA104	1000	968	30	405	£211	£47
MSDA084	800	768	30	405	£192	£47
MSRA084	800 Return Side	768	30	380	£192	£47
MSRA064	600 Return Side	568	30	380	£169	£47



Mesa Plus Rectangular Double Sided Desking with Mesa Plus Fabric Desk Mounted Screen

Mirage Lite is a 28mm thick, non-pinnable frameless desk top screen system that is designed to fit to Gresham 25mm thick worksurfaces. The range is available in five distinct profile shapes and all screens are supplied with brackets that allow them to be simply fitted into place.

These slim-line screens can be upholstered in a choice of vibrant fabrics that not only help to delineate user space but also can add colour highlights in modern workspace environments. Tackable versions are available for a surcharge.

Additional Information:

- Frameless design.
- 28mm thick frameless upholstered screens.
- Brackets available in Black, Grey, Silver or White.
- Available in five unique designs.
- Fit to front/rear edge of desks/workstations.
- **Note 'Arrow' screens do not fit on Bench Desk (BK).**
- For Tackable version, please prefix T onto front of code *i.e* TML1804-2/1. Surcharge £91 per screen.

## SCREEN OPTIONS



**Bow Shaped Screen**



**Curved Shaped Screen**



**Arrow Shaped Screen**

Arrow screens do not fit on Bench Desk (BK)



**Angle Shaped Screen**



**Straight Screen**

## MIRAGE LITE FABRIC OPTIONS

**Band A**  
Camira Cara

**Band B**  
Camira Lucia  
Camira Sonus  
Camira Carlow  
Camira Gravity  
Inloom Erika  
Inloom Alba  
Inloom Bondai

**Band C**  
Camira Patina  
Camira X2  
Camira Aspect  
Camira Extreme  
Agua Chea  
Agua Task

**Band D**  
Camira Blazer Lite  
Camira Nexus

**Band E**  
Camira Blazer  
Camira Synergy  
Camira Aquarius  
Agua Lavoro  
Agua Buro  
Inloom Bioactive  
Inloom Roccia  
Inloom One  
Camira Oxygen  
Camira Quest



Bow Shaped Screen on Bench Desk

# MIRAGE LITE SCREENS & PODS

5 Year  
Guarantee

Code	Description	Band A	Band B	Band C	Band D	Band E
<b>Bow Shaped Screens</b>						
ML2004-1	1970w x 380h x 28	£274	£358	£463	£534	£706
ML1804-1	1770w x 380h x 28	£255	£322	£404	£464	£601
ML1604-1	1570w x 380h x 28	£218	£253	£368	£420	£531
ML1404-1	1370w x 380h x 28	£213	£247	£326	£378	£458
ML1204-1	1170w x 380h x 28	£208	£242	£282	£312	£384
ML1004-1	970w x 380h x 28	£206	£240	£278	£307	£380
ML0804-1	770w x 380h x 28	£194	£230	£270	£297	£369
<b>Curved Shaped Screens</b>						
ML2004-2	1970w x 380h x 28	£274	£358	£463	£534	£706
ML1804-2	1770w x 380h x 28	£255	£322	£404	£464	£601
ML1604-2	1570w x 380h x 28	£218	£253	£368	£420	£531
ML1404-2	1370w x 380h x 28	£213	£247	£326	£378	£458
ML1204-2	1170w x 380h x 28	£208	£242	£282	£312	£384
ML1004-2	970w x 380h x 28	£206	£240	£278	£307	£380
ML0804-2	770w x 380h x 28	£194	£230	£270	£297	£369
<b>Arrow Shaped Screens</b>						
ML2004-6*	1970w x 380h x 28	£274	£358	£463	£534	£706
ML1804-6*	1770w x 380h x 28	£255	£322	£404	£464	£601
ML1604-6*	1570w x 380h x 28	£218	£253	£368	£420	£531
ML1404-6*	1370w x 380h x 28	£213	£247	£326	£378	£458
ML1204-6*	1170w x 380h x 28	£208	£242	£282	£312	£384
ML1004-6*	970w x 380h x 28	£206	£240	£278	£307	£380
ML0804-6*	770w x 380h x 28	£194	£230	£270	£297	£369
<b>Angled Shaped Screens</b>						
ML2004-9	1970w x 380h x 28	£314	£412	£500	£575	£762
ML1804-9	1770w x 380h x 28	£289	£368	£441	£497	£646
ML1604-9	1570w x 380h x 28	£252	£292	£396	£438	£566
ML1404-9	1370w x 380h x 28	£246	£287	£358	£390	£496
ML1204-9	1170w x 380h x 28	£236	£276	£310	£341	£418
ML1004-9	970w x 380h x 28	£233	£274	£306	£338	£413
<b>Straight Screens</b>						
ML2004-10	1970w x 380h x 28	£274	£358	£463	£534	£706
ML1804-10	1770w x 380h x 28	£255	£322	£404	£464	£601
ML1604-10	1570w x 380h x 28	£218	£253	£368	£420	£531
ML1404-10	1370w x 380h x 28	£213	£247	£326	£378	£458
ML1204-10	1170w x 380h x 28	£208	£242	£282	£312	£384
ML1004-10	970w x 380h x 28	£206	£240	£278	£307	£380
ML0804-10	770w x 380h x 28	£194	£230	£270	£297	£369

\* Do not fit to Bench Deskit (BK) desks/workstations. All prices shown include brackets



Curved Shaped Screen on Design 2000 Deskit

## FIXING BRACKETS

Please note certain configurations may result in the desk top screen being positioned 'off centre'.

Screen brackets are for front/rear of desks only. Brackets available in Silver, White, Black or Grey.

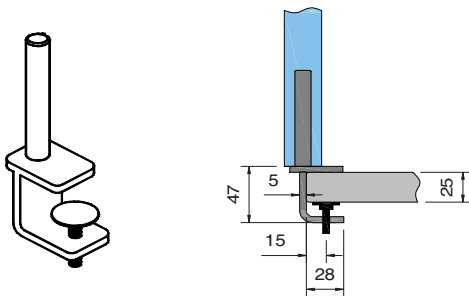

Usable jaw size of 17-33mm

**Type /1 – 25mm clamp brackets (pair)**

For use on the following:

- Deskit
- Bench<sup>2</sup> Fixed Top (Single Sided)
- Bench<sup>2</sup> Scallop Top (Single Sided)
- Rise & Rise LT
- D3K Fully Welded
- D2000 Fully Welded

**Suffix screen code with /1**

Example of code = ML1604-10/1

(Mirage Lite 1570 x 380 Straight Screen with Type 1 brackets)

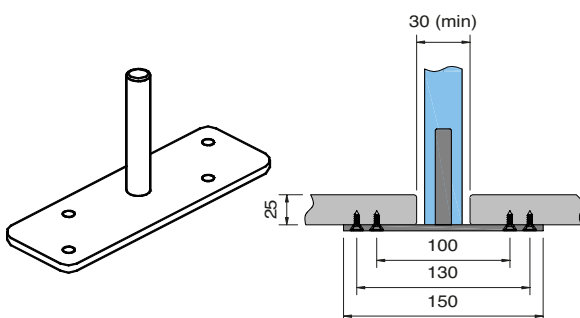

Minimum gap of 30mm between tops required

**Type /2 – back to back bench bracket (pair)**

Screw fixings supplied

For use on the following:

- Mesa Plus (Double Sided)

**Suffix screen code with /2**

Example of code = TML1404-1/2

(Mirage Lite 1370 x 380 Arrow Tackable Screen with Type 2 brackets)

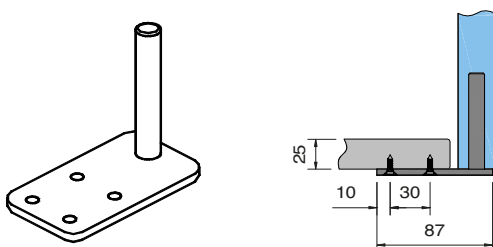
**Type /3 – single sided bench bracket (pair)**

Screw fixings supplied

For use on the following:

- Mesa Plus (Single Sided)

**Suffix screen code with /3**

Example of code = ML1804-6/3

(Mirage Lite 1770 x 380 Bow Screen with Type 3 brackets)

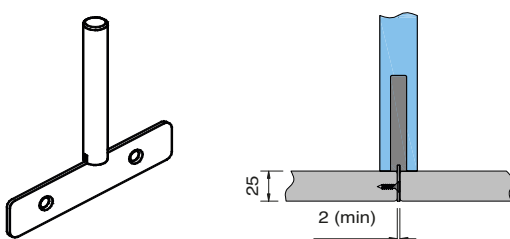

Minimum gap of 2mm between tops required

**Type /4 – Slim bracket (pair)**

Screw fixings supplied

For use on the following:

- Bench<sup>2</sup> Fixed Top (Double Sided)
- Bench<sup>2</sup> Scallop Top (Double Sided)

**Suffix screen code with /4**

Example of code = TML1604-2/4

(Mirage Lite 1570 x 380 Curved Tackable Screen with Type 4 brackets)

## RETURN DESKTOP SCREENS

The Mirage Lite Return Screen is designed as an interference fit, so it can be installed and removed several times on a desk top as standard. A metal bracket fixed into the jaw is shaped to contact the desktop at a single point. The bracket creates an undersized gap, but flexes to ensure tight fitting. The second contact point is from the wooden jaw of the screen, this is not structural, just offering some stability. The bracket after time may be pushed down past its elastic point, and could require a slight adjustment back into its original shape to reinstate a tight fit, a gentle pull upwards should achieve this. The screens are designed only as a partition, not a location for accessories to be fitted. They are designed only to support the mass and forces of the screen itself, not anything additional such as people leaning, pushing or twisting once in situ.



Screens & Pods

Code	Description	Band A	Band B	Band C	Band D	Band E
<b>Xtreme</b>						
<b>Return Screens</b>						
ML1004-R	Return Desk Top Screen 1000w x 380h x 28	£315	£356	£386	£455	£517
ML0804-R	Return Desk Top Screen 800w x 380h x 28	£300	£339	£371	£389	£505
ML0604-R	Return Desk Top Screen 600w x 380h x 28	£284	£321	£357	£371	£387

**Please Note:**

Return Screens may need to be positioned to avoid End Frames and Pedestals.  
Tackable versions are not available on return screens.

## SCREEN POSITIONING

When ordering screens, ensure you know where they will be positioned so that the correct screen can be specified. Standard Rear Screens are supplied with brackets, whilst Return Screens are fitted with spring clips.

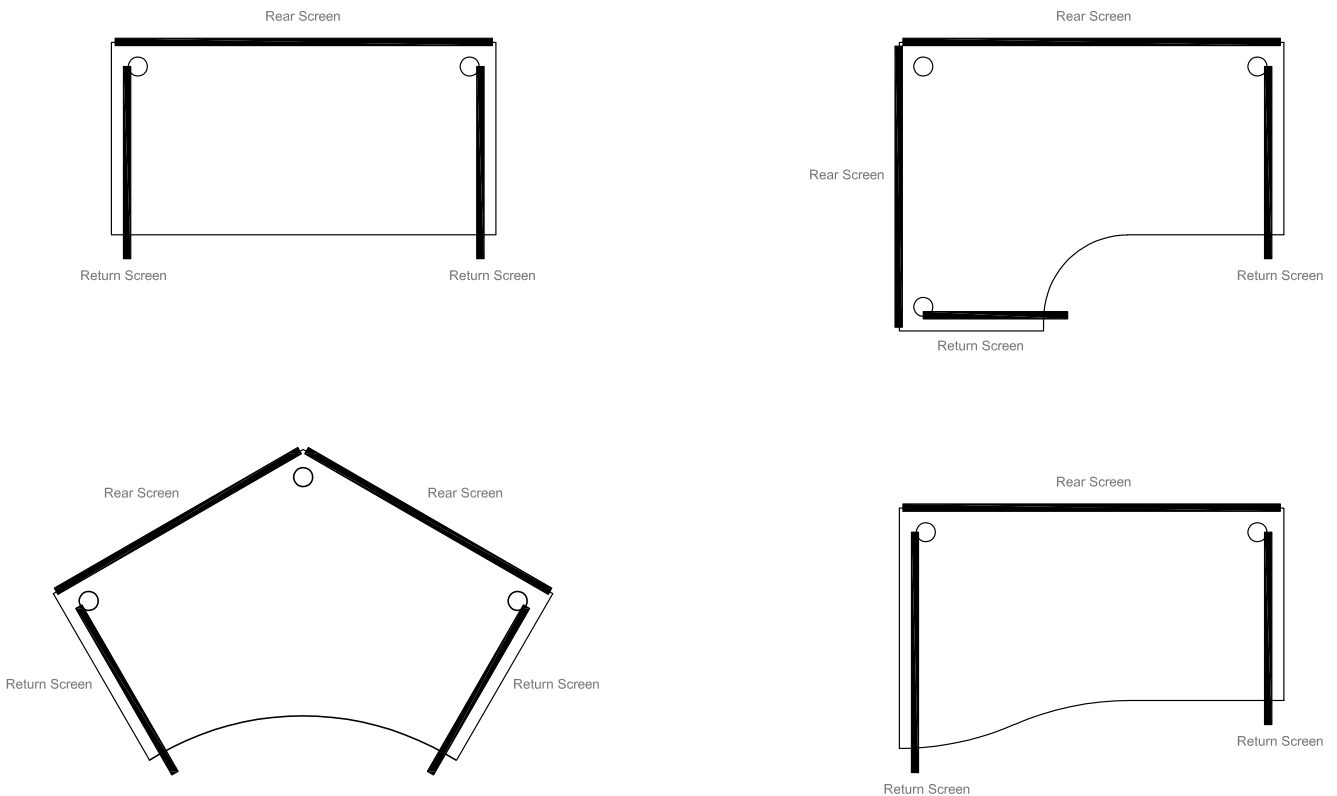



GE6 Mobile Screens Grey GE6 – Camira Synergy Mix, Synergy Partner, Synergy Serendipity (Band 3) Return Desktop Screens Camira Lucia Appledoore

# GE ACOUSTICS SCREENS & PODS

5 Year  
Guarantee

The workplace and the way we work are constantly evolving. We are continually required to create new spaces within existing environments with an increasing demand on sound absorbency. To meet this demand, Gresham Acoustics are available as a sound absorbing wall or ceiling mounted tile.

The hand crafted nature of the manufacturing of Acoustics allows any shape or size to be created, leaving no limitation to the product, only your imagination. This flexibility is embedded within the product in all forms including size, thickness, shape, fabrics and uses, all of which can be tailored to your exact requirements.

With limited floor space available in offices, empty walls or vertical surfaces can be used to absorb unwanted noise to help staff concentrate. Wall tiles, colours, patterns, texture, shape and tessellation can be introduced to otherwise plain and commonly white spaces while providing the dual function of sound absorption. Consider covering not just walls, but cupboard backs, doors and pillars.



Screens & Pods

Code	Thickness	Height	Width	Price			
<b>Clouds</b>							
Ceiling hung - Can be hung horizontally on most ceilings. A variety of fixings are available to connect the tiles to the ceilings, with steel cable kits provided as standard.							
				Camira: Cara			
				Camira: Rivet, Carlow			
				Camira: Blazer, Blazer Lite, Synergy, Sonus, Agua Buro, Inloom Jet Bioactive, Inloom One, Inloom Roccia			
GE11A1	40	x	820	x 1030	£532	£566	£654
GE11A2	65	x	820	x 1030	£561	£595	£681
GE11B1	40	x	920	x 1300	£593	£678	£852
GE11B2	65	x	920	x 1300	£643	£728	£901

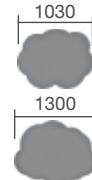

Code	Thickness	Diameter	Price
------	-----------	----------	-------

## Circles & Doughnuts

Ceiling hung - Can be hung horizontally on most ceilings. A variety of fixings are available to connect the tiles to the ceilings, with steel cable kits provided as standard.

GE12A1	40	x	500	£367	£377	£460
GE12A2	65	x	500	£409	£420	£520
GE12B1	40	x	750	£451	£485	£563
GE12B2	65	x	750	£511	£550	£650
GE12C1	40	x	1000	£482	£539	£684
GE12C2	65	x	1000	£522	£578	£724
GE13A1	40	x	500/250	£484	£493	£576
GE13A2	65	x	500/250	£526	£534	£636
GE13B1	40	x	750/500	£568	£601	£681
GE13B2	65	x	750/500	£628	£667	£767
GE13C1	40	x	1000/750	£600	£655	£802
GE13C2	65	x	1000/750	£638	£696	£841



## Additional Information

Hanging Wire supplied as standard (see picture below)

⚠ If installing on suspended ceiling, verify load capacity prior to installation.



### Suspended Ceiling Grid Clip

GECLIP	To Suit 15mm Grid Ceilings	£51 Per Tile
GECLIP	To Suit 24/25mm Grid Ceilings	£51 Per Tile

Code	Thickness	Height	Width	Price
------	-----------	--------	-------	-------

## Square Ceiling Grid

Ceiling hung - Can be hung horizontally on most ceiling grid systems. No fixings required, the lip around the edge of the tile slots into existing ceiling grid.

GE25A1	40	x	595	x	595
--------	----	---	-----	---	-----



## Additional Information

Tile rests on supports. No additional fixings necessary.

⚠ If installing on suspended ceiling, verify load capacity prior to installation.





Code	Thickness	Height	Width	Price	Camira: Cara	Camira: Rivet, Carlow	Camira: Blazer, Blazer Lite, Synergy, Sonus, Agua Buro, Inloom Jet Bioactive, Inloom Roccia, Inloom One	
<b>Square</b>								
Wall hung - Can be hung vertically or at angles on most walls. A variety of fixings are available to connect the tiles to the walls.								
GE14A1	40	x	600	x	600	£208	£235	£301
GE14A2	65	x	600	x	600	£231	£254	£333
GE14B1	40	x	800	x	800	£285	£328	£440
GE14B2	65	x	800	x	800	£315	£357	£468
GE14C1	40	x	1000	x	1000	£341	£404	£573
GE14C2	65	x	1000	x	1000	£387	£450	£619
GE14D1	40	x	1200	x	1200	£377	£442	£608
GE14D2	65	x	1200	x	1200	£443	£509	£674
<b>Rectangle</b>								
GE15A1	40	x		x	1000	£187	£205	£246
GE15A2	65	x		x	1000	£201	£217	£260
GE15B1	40	x		x	1200	£192	£208	£253
GE15B2	65	x	400	x	1200	£209	£227	£270
GE15C1	40	x		x	1400	£196	£286	£414
GE15C2	65	x		x	1400	£217	£305	£436
GE15D1	40	x		x	1600	£202	£328	£492
GE15D2	65	x		x	1600	£225	£350	£513
GE15E1	40	x		x	1000	£233	£266	£352
GE15E2	65	x		x	1000	£260	£293	£380
GE15F1	40	x		x	1200	£241	£275	£363
GE15F2	65	x	800	x	1200	£276	£346	£477
GE15G1	40	x		x	1400	£314	£399	£531
GE15G2	65	x		x	1400	£358	£405	£573
GE15H1	40	x		x	1600	£348	£397	£542
GE15H2	65	x		x	1600	£365	£414	£589
GE15J1	40	x		x	1000	£355	£387	£486
GE15J2	65	x		x	1000	£399	£412	£498
GE15K1	40	x	1000	x	1200	£361	£393	£550
GE15K2	65	x	1000	x	1200	£410	£426	£600
GE15L1	40	x		x	1400	£377	£409	£562
GE15L2	65	x		x	1400	£422	£447	£621



**Apex**  
Wall hung. A variety of fixings are available to connect the tiles to the walls. \*prices shown are for single colour fabrics only

GE16A1			500	x	500	£348	£367	£410
GE16B1	120	x	700	x	700	POA	POA	POA
GE24A1			500	x	500	£348	£367	£410
GE24B1	120	x	700	x	700	POA	POA	POA
GE18A1			500	x	500	£348	£367	£410
GE18B1	120	x	700	x	700	POA	POA	POA



**Arrow**  
Wall hung - Can be hung vertically or at angles on most walls. A variety of fixings are available to connect the tiles to the walls, with Velcro provided as standard.

GE19A1	40		500	x	500	£214	£229	£325
GE19A21	65	x	500	x	500	£252	£265	£356



**Hexagon**  
Wall hung - Can be hung vertically or at angles on most walls. A variety of fixings are available to connect the tiles to the walls.

GE20A1	40	x	433	x	500	£187	£195	£277
GE20A2	65	x	433	x	500	£228	£239	£339
GE20B1	40	x	606	x	700	£273	£303	£387
GE20B2	65	x	606	x	700	£333	£371	£470
GE20C1	40	x	779	x	900	£292	£335	£446
GE20C2	65	x	779	x	900	£350	£413	£580



Additional Information  
Velcro Strips supplied as standard.

# BARRIER SCREENS

## SCREENS & PODS

### Specification

- 5mm free standing clear acrylic protection screens
- 8mm clear acrylic feet for stability
- Clear finish only

Code	Description	Price
Fully Glazed Free Standing Screen - 975mm w x 725mm h		
SNS250	Fully Glazed Screen with 250mm X 50mm Cut-out	£212
SNS300	Fully Glazed Screen with 300mm X 50mm Cut-out	£212
SNS350	Fully Glazed Screen with 350mm X 50mm Cut-out	£212

Other sizes available on request

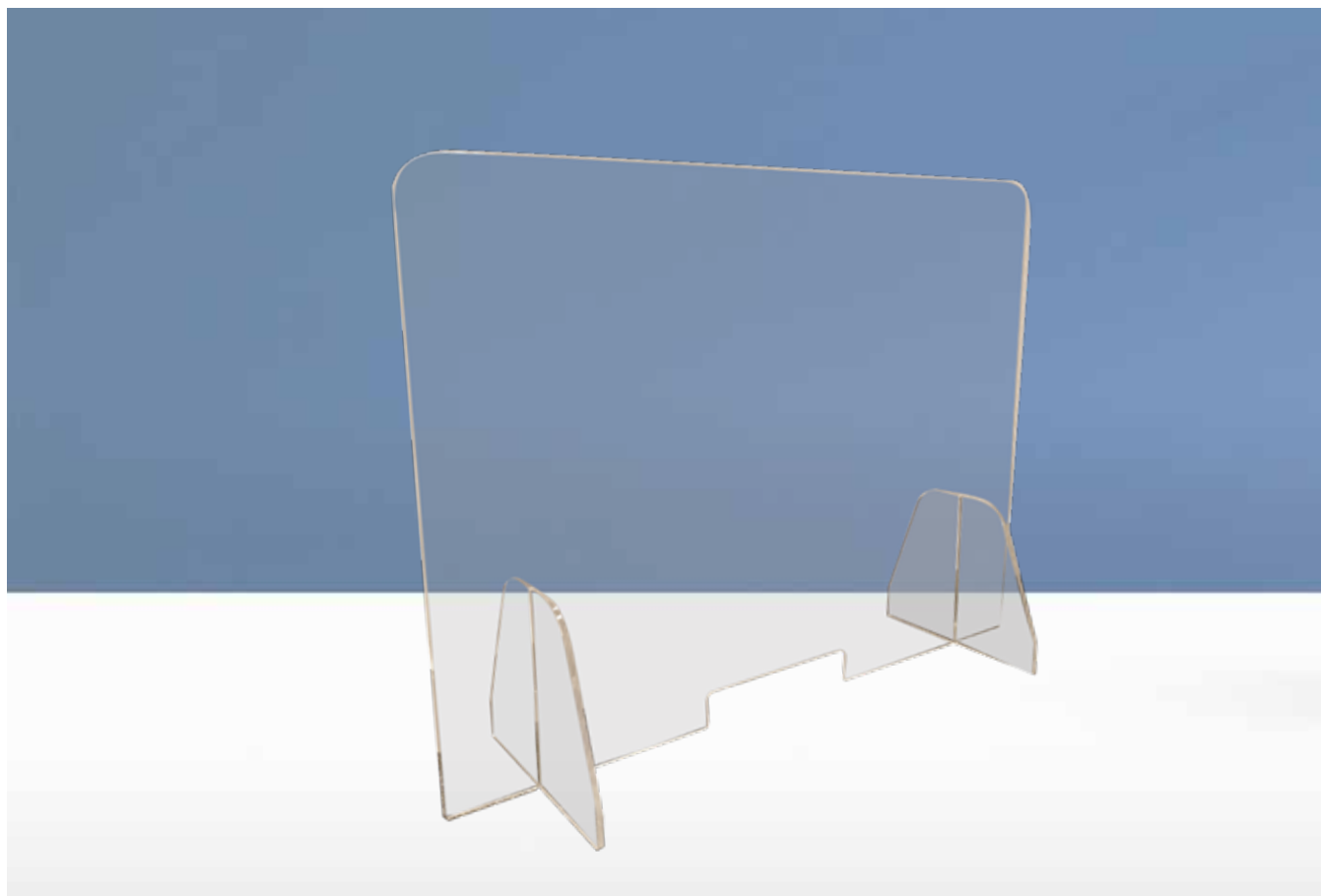

## FITS TO DESKTOP SCREEN

\* New Design (now finish size)

### Specification

- 5mm thick
- Clear acrylic, easily cleanable
- Supplied with 2 x fixing brackets
- Can be added to GOF desk mounted screens and Mirage Lite Straight screens
- Edges are diamond polished with all sharp corners removed

## GLAZED VISION PANELS SCREENS & PODS

### Acrylic Options -

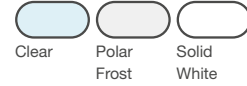

Solid White is a surcharge +25%

### Bracket -



For GOF vision panels brackets suffix code with -VP (e.g. VS185S-VP) 10 - 38mm Adjustment

Code	Description (finish size)	Price
300mm High		
VS063S	Fully Glazed Vision Panel 600W X 300H	£166
VS083S	Fully Glazed Vision Panel 800W X 300H	£187
VS103S	Fully Glazed Vision Panel 1000W X 300H	£202
VS123S	Fully Glazed Vision Panel 1200W X 300H	£220
VS143S	Fully Glazed Vision Panel 1400W X 300H	£239
VS163S	Fully Glazed Vision Panel 1600W X 300H	£259
VS183S	Fully Glazed Vision Panel 1800W X 300H	£276
500mm High		
VS065S	Fully Glazed Vision Panel 600W X 500H	£193
VS085S	Fully Glazed Vision Panel 800W X 500H	£233
VS105S	Fully Glazed Vision Panel 1000W X 500H	£266
VS125S	Fully Glazed Vision Panel 1200W X 500H	£303
VS145S	Fully Glazed Vision Panel 1400W X 500H	£339
VS165S	Fully Glazed Vision Panel 1600W X 500H	£379
VS185S	Fully Glazed Vision Panel 1800W X 500H	£418



# FREE STANDING DESKTOP SCREENS SCREENS & PODS

## Specification

- 5mm thick
- Clear acrylic, easily cleanable
- Supplied with 2 x fixing brackets
- Can be used as stand-alone screens
- Edges are diamond polished with all sharp corners removed
- Optional cut-out size 300mm X 100mm

### Acrylic Options -



Solid White is a surcharge +25%

Code	Code with Cut Out	Description (finish size)	Price
600mm High			
FS0606	N/A	Fully Glazed Screen 600W X 600H	£207
FS0608	N/A	Fully Glazed Screen 800W X 600H	£239
FS0610	FS0610C	Fully Glazed Screen 1000W X 600H	£273
FS0612	FS0612C	Fully Glazed Screen 1200W X 600H	£300
FS0614	FS0614C	Fully Glazed Screen 1400W X 600H	£326
FS0616	FS0616C	Fully Glazed Screen 1600W X 600H	£361
FS0618	FS0618C	Fully Glazed Screen 1800W X 600H	£393
800mm High			
FS0806	N/A	Fully Glazed Screen 600W X 800H	£237
FS0808	N/A	Fully Glazed Screen 800W X 800H	£276
FS0810	FS0810C	Fully Glazed Screen 1000W X 800H	£318
FS0812	FS0812C	Fully Glazed Screen 1200W X 800H	£353
FS0814	FS0814C	Fully Glazed Screen 1400W X 800H	£390
FS0816	FS0816C	Fully Glazed Screen 1600W X 800H	£420
FS0818	FS0818C	Fully Glazed Screen 1800W X 800H	£452
1100mm High			
FS1106	N/A	Fully Glazed Screen 600W X 1100H	£266
FS1108	N/A	Fully Glazed Screen 800W X 1100H	£314
FS1110	FS1110C	Fully Glazed Screen 1000W X 1100H	£361
FS1112	FS1112C	Fully Glazed Screen 1200W X 1100H	£405
FS1114	FS1114C	Fully Glazed Screen 1400W X 1100H	£452
FS1116	FS1116C	Fully Glazed Screen 1600W X 1100H	£484
FS1118	FS1118C	Fully Glazed Screen 1800W X 1100H	£518



# SCREEN BRACKETS & ACCESSORIES

## SCREENS & PODS

### Specification

\*Please note brackets will increase in height when used with 1100h screens

- Brackets for a range of uses
- Cat flap
- Hinge brackets, fixed brackets and more



#### Fixed Bracket

Fixed screen brackets must be screw fixed for stability - supplied in pairs

For screen with fixed bracket panels suffix code with -FP (e.g. FS0618C-FP)



#### Free standing Bracket

Free standing bracket for sitting onto desktop (can be screw fixed for stability) - supplied in pairs.

For screen with free standing bracket panels suffix code with -FS (e.g. FS0618C-FS)



#### Clamp Bracket

Clamp bracket to suit rear of desktop (suit 25mm top panel) - supplied in pairs

For screen with clamp bracket panels suffix code with -CB (e.g. FS0618C-CB)



#### Divider Bracket **\*Please note £27 net Surcharge\***

Clamp bracket to suit side of desk/table (Adjustable from 25mm - 75mm) - supplied in pairs

For screen with divider bracket panels suffix code with -DB (e.g. FS0618C-DB)



Cat Flap **\*\*Please note £66 net each\*\***  
Swing open cat flap to bottom of screen



Hinges **\*\*Please note £5 net each\*\***  
90°, 4 way, 3 way (left to right)

# CLUSTER SCREENS

## SCREENS & PODS

### Specification

- 5mm thick
- Clear acrylic, easily cleanable
- Stand alone screen
- Return screens
- Supplied with bracket for fixing on return screens
- Adjustable bracket along void

### Acrylic Options -



Solid White is a surcharge  
+25%

Screens & Pods

Code	Description (finish size)	Price
600mm High With 600mm Deep Return		
FSRS06606	600W X 600H Rear Screen with 600D X 600H Return	£486
FSRS08606	800W X 600H Rear Screen with 600D X 600H Return	£512
FSRS10606	1000W X 600H Rear Screen with 600D X 600H Return	£543
FSRS12606	1200W X 600H Rear Screen with 600D X 600H Return	£563
FSRS14606	1400W X 600H Rear Screen with 600D X 600H Return	£591
FSRS16606	1600W X 600H Rear Screen with 600D X 600H Return	£619
600mm High With 800mm Deep Return		
FSRS06608	600W X 600H Rear Screen with 800D X 600H Return	£554
FSRS08608	800W X 600H Rear Screen with 800D X 600H Return	£578
FSRS10608	1000W X 600H Rear Screen with 800D X 600H Return	£610
FSRS12608	1200W X 600H Rear Screen with 800D X 600H Return	£632
FSRS14608	1400W X 600H Rear Screen with 800D X 600H Return	£658
FSRS16608	1600W X 600H Rear Screen with 800D X 600H Return	£684
600mm High With 1000mm Deep Return		
FSRS06610	600W X 600H Rear Screen with 1000D X 600H Return	£620
FSRS08610	800W X 600H Rear Screen with 1000D X 600H Return	£645
FSRS10610	1000W X 600H Rear Screen with 1000D X 600H Return	£677
FSRS12610	1200W X 600H Rear Screen with 1000D X 600H Return	£698
FSRS14610	1400W X 600H Rear Screen with 1000D X 600H Return	£724
FSRS16610	1600W X 600H Rear Screen with 1000D X 600H Return	£751

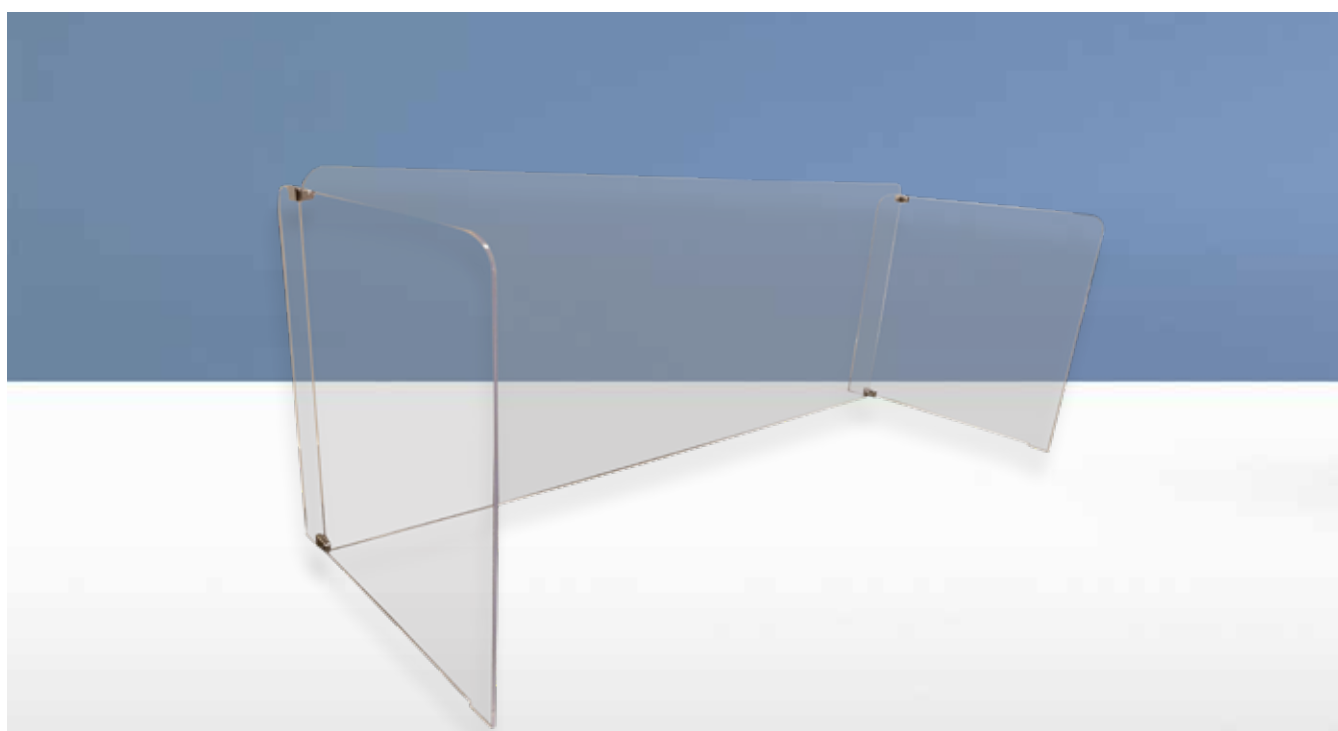

# CLUSTER SCREENS SCREENS & PODS

Code	Description (finish size)	Price
800mm High With 600mm Deep Return		
FSRS06806	600W X 800H Rear Screen with 600D X 800H Return	£598
FSRS08806	800W X 800H Rear Screen with 600D X 800H Return	£633
FSRS10806	1000W X 800H Rear Screen with 600D X 800H Return	£667
FSRS12806	1200W X 800H Rear Screen with 600D X 800H Return	£703
FSRS14806	1400W X 800H Rear Screen with 600D X 800H Return	£738
FSRS16806	1600W X 800H Rear Screen with 600D X 800H Return	£771
800mm High With 800mm Deep Return		
FSRS06808	600W X 800H Rear Screen with 800D X 800H Return	£665
FSRS08808	800W X 800H Rear Screen with 800D X 800H Return	£699
FSRS10808	1000W X 800H Rear Screen with 800D X 800H Return	£734
FSRS12808	1200WX 800H Rear Screen with 800D X 800H Return	£769
FSRS14808	1400W X 800H Rear Screen with 800D X 800H Return	£804
FSRS16808	1600W X 800H Rear Screen with 800D X 800H Return	£838
800mm High With 1000mm Deep Return		
FSRS06810	600W X 800H Rear Screen with 1000D X 800H Return	£730
FSRS08810	800WX 800H Rear Screen with 1000D X 800H Return	£766
FSRS10810	1000W X 800H Rear Screen with 1000D X 800H Return	£799
FSRS12810	1200W X 800H Rear Screen with 1000D X 800H Return	£835
FSRS14810	1400WX 800H Rear Screen with 1000D X 800H Return	£872
FSRS16810	1600W X 800H Rear Screen with 1000D X 800H Return	£905

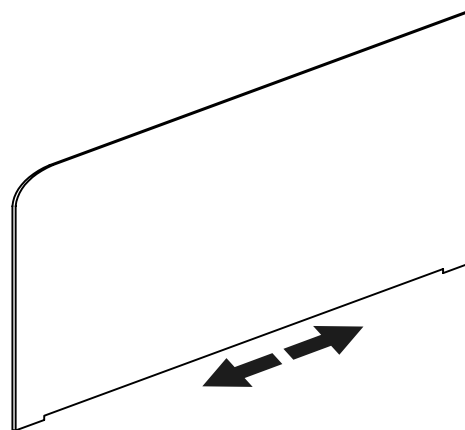
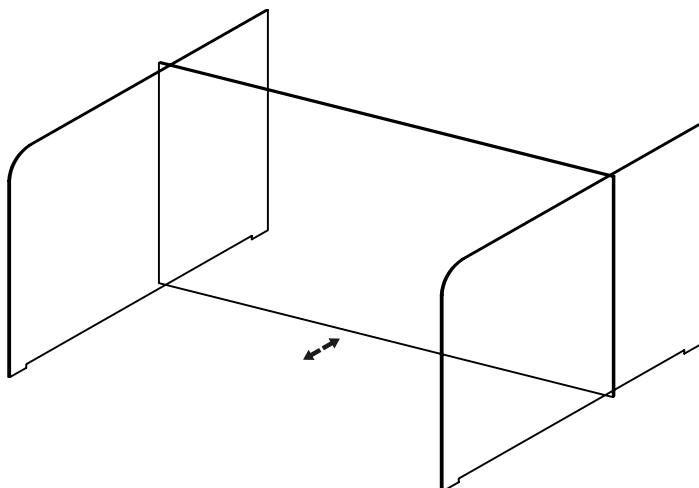

Bracket is adjustable along the void

# CURVED VISION PANELS - MIRAGE LITE

## SCREENS & PODS

### Specification

- 5mm thick
- Clear acrylic, easily cleanable
- Supplied with 2 x fixing brackets
- Can be added to Mirage Lite curved desk mounted screens
- Edges are diamond polished with all sharp corners removed

### Acrylic Options -



Solid White is a surcharge +25%

Code	Description (finish size)	Price
300mm High		
SML0603	Fully Glazed Screen Shaped to Suit Mirage Lite 570W X 300H	£353
SML0803	Fully Glazed Screen Shaped to Suit Mirage Lite 770W X 300H	£357
SML1003	Fully Glazed Screen Shaped to Suit Mirage Lite 970W X 300H	£393
SML1203	Fully Glazed Screen Shaped to Suit Mirage Lite 1170W X 300H	£426
SML1403	Fully Glazed Screen Shaped to Suit Mirage Lite 1370W X 300H	£460
SML1603	Fully Glazed Screen Shaped to Suit Mirage Lite 1570W X 300H	£496
SML1803	Fully Glazed Screen Shaped to Suit Mirage Lite 1770W X 300H	£586
400mm High		
SML0604	Fully Glazed Screen Shaped to Suit Mirage Lite 570W X 400H	£397
SML0804	Fully Glazed Screen Shaped to Suit Mirage Lite 770W X 400H	£399
SML1004	Fully Glazed Screen Shaped to Suit Mirage Lite 970W X 400H	£443
SML1204	Fully Glazed Screen Shaped to Suit Mirage Lite 1170W X 400H	£493
SML1404	Fully Glazed Screen Shaped to Suit Mirage Lite 1370W X 400H	£532
SML1604	Fully Glazed Screen Shaped to Suit Mirage Lite 1570W X 400H	£573
SML1804	Fully Glazed Screen Shaped to Suit Mirage Lite 1770W X 400H	£676
500mm High		
SML0605	Fully Glazed Screen Shaped to Suit Mirage Lite 570W X 500H	£436
SML0805	Fully Glazed Screen Shaped to Suit Mirage Lite 770W X 500H	£443
SML1005	Fully Glazed Screen Shaped to Suit Mirage Lite 970W X 500H	£496
SML1205	Fully Glazed Screen Shaped to Suit Mirage Lite 1170W X 500H	£545
SML1405	Fully Glazed Screen Shaped to Suit Mirage Lite 1370W X 500H	£603
SML1605	Fully Glazed Screen Shaped to Suit Mirage Lite 1570W X 500H	£657
SML1805	Fully Glazed Screen Shaped to Suit Mirage Lite 1770W X 500H	£769





# MOBILE FLOOR STANDING SCREENS SCREENS & PODS

## Specification

- 3mm thick
- Clear acrylic, easily cleanable
- Mobile frame
- On lockable castors

### Acrylic Options -

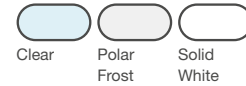

Solid White is a surcharge +25%

Code	Description (finish size)	Price
1400mm High		
MSA1408	Mobile Glazed Screen 800W X 1400H	£433
MSA1410	Mobile Glazed Screen 1000W X 1400H	£516
MSA1412	Mobile Glazed Screen 1200W X 1400H	£692
1600mm High		
MSA1608	Mobile Glazed Screen 800W X 1600H	£452
MSA1610	Mobile Glazed Screen 1000W X 1600H	£559
MSA1612	Mobile Glazed Screen 1200W X 1600H	£725
1800mm High		
MSA1808	Mobile Glazed Screen 800W X 1800H	£484
MSA1810	Mobile Glazed Screen 1000W X 1800H	£590
MSA1812	Mobile Glazed Screen 1200W X 1800H	£792
Linking Brackets		
FLA90	90 Degree Bracket (supplied in pairs)	£33
FLAST	Straight Link Bracket (supplied in pairs)	£33



# STATIC FLOOR STANDING SCREENS SCREENS & PODS

## Specification

- 3mm thick
- Clear acrylic, easily cleanable
- Static frame

### Acrylic Options -



Solid White is a surcharge +25%

Code	Description (finish size)	Price
1400mm High		
FSA1408	Static Glazed Screen 800W X 1400H	£412
FSA1410	Static Glazed Screen 1000W X 1400H	£496
FSA1412	Static Glazed Screen 1200W X 1400H	£671
1600mm High		
FSA1608	Static Glazed Screen 800W X 1600H	£433
FSA1610	Static Glazed Screen 1000W X 1600H	£539
FSA1612	Static Glazed Screen 1200W X 1600H	£705
1800mm High		
FSA1808	Static Glazed Screen 800W X 1800H	£464
FSA1810	Static Glazed Screen 1000W X 1800H	£571
FSA1812	Static Glazed Screen 1200W X 1800H	£771
Linking Brackets		
FLA90	90 Degree Bracket (supplied in pairs)	£33
FLAST	Straight Link Bracket (supplied in pairs)	£33



# MFC & ACRYLIC SCREENS SCREENS & PODS

## Specification

- 3mm thick acrylic
- Floor standing
- Lower section in MFC
- Upper section in acrylic
- Static frame
- Choice of MFC finishes

### Acrylic Options -

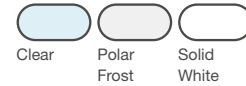

Solid White is a surcharge +25%

Code	Description (finish size)	Price
1600mm High		
FSW0816	800W x 1600H Floor Standing Screen with MFC (lower)	£507
FSW1016	1000W x 1600H Floor Standing Screen with MFC (lower)	£514
FSW1216	1200W x 1600H Floor Standing Screen with MFC (lower)	£553
FSW1416	1400W x 1600H Floor Standing Screen with MFC (lower)	£633
FSW1616	1600W x 1600H Floor Standing Screen with MFC (lower)	£640
1800mm High		
FSW0818	800W x 1800H Floor Standing Screen with MFC (lower)	£541
FSW1018	1000W x 1800H Floor Standing Screen with MFC (lower)	£555
FSW1218	1200W x 1800H Floor Standing Screen with MFC (lower)	£591
FSW1418	1400W x 1800H Floor Standing Screen with MFC (lower)	£675
FSW1618	1600W x 1800H Floor Standing Screen with MFC (lower)	£686
2000mm High		
FSW0820	800W x 2000H Floor Standing Screen with MFC (lower)	£555
FSW1020	1000W x 2000H Floor Standing Screen with MFC (lower)	£570
FSW1220	1200W x 2000H Floor Standing Screen with MFC (lower)	£608
FSW1420	1400W x 2000H Floor Standing Screen with MFC (lower)	£696
FSW1620	1600W x 2000H Floor Standing Screen with MFC (lower)	£706



# INTRODUCTION

## STORAGE





For metal finishes please see  
Technical Information section.

Pastel Paint  
Surcharge = £32 per item.



For board finishes please see  
Technical Information section.

Adlington Oak  
Surcharge = 15% per item  
Dark Concrete  
Surcharge = 15% per item

We offer a comprehensive range of storage units, including a variety of pedestals, hinged door, tambour fronted, open fronted and filing units.

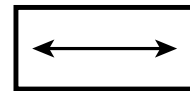

denotes grain  
direction

- Three handle options are available, please see below for details.
- All locking units have a suited key system with optional master keys. 2 Keys are supplied with every lockable unit - one with collapsible / folding fob.

## HOW TO SPECIFY YOUR HANDLE

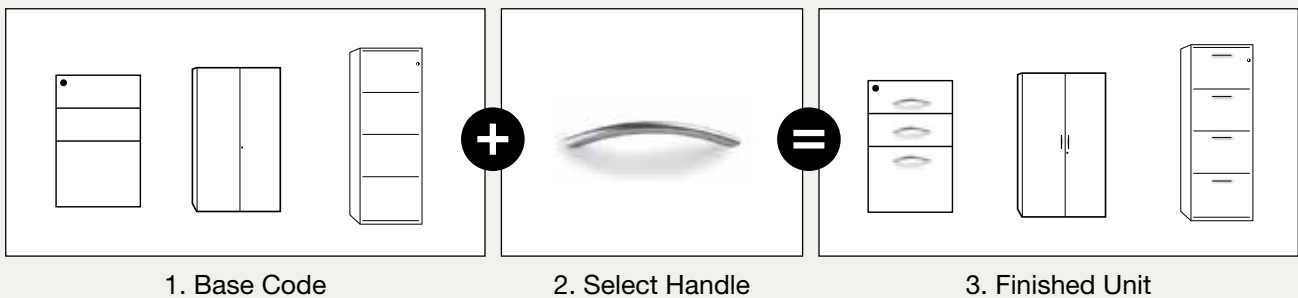

Handle type B				
	BLACK	GREY	WHITE	SILVER
Handle type C				
	BLACK	GREY	WHITE	SILVER
Handle type D				
	BLACK	GREY	WHITE	SILVER

# PEDESTALS STORAGE



Pedestals are designed to suit all desking ranges and are available as mobile or static.

- Available with two, three and four drawers - including shallow & filing drawers.
- Desk high pedestals are available in 600mm and 800mm depths.

Base code	Description	W	D	H	MFC Price
-----------	-------------	---	---	---	-----------

### Under Desk

Mobile	Static	Description	W	D	H	MFC Price		
2DM	2DS	2 drawer	430	x 600	x 555	£333	↑↓	
3DM	3DS	3 drawer	430	x 600	x 555	£333		

### Tall Under Desk

Mobile	Static	Description	W	D	H	MFC Price		
3PUM	3PUS	3 drawer	430	x 600	x 625	£415	↑↓	

Please note, Tall Under Desk pedestals do not work with Bench<sup>2</sup> single sided desks with increased depth trays

### Tall Under Desk Slimline

Mobile	Static	Description	W	D	H	MFC Price		
3SPUM	3SPUS	3 drawer	340	x 600	x 625	£415	↑↓	

Please note, Tall Under Desk pedestals do not work with Bench<sup>2</sup> single sided desks with increased depth trays

### 600mm Deep Desk High

Mobile	Static	Description	W	D	H	MFC Price		
2D6M	2D6S	2 drawer	430	x 600	x 727	£469	↑↓	
3D6M	3D6S	3 drawer	430	x 600	x 727	£446		
4D6M	4D6S	4 drawer	430	x 600	x 727	£469		

### 600mm Deep Desk High - Slimline

Mobile	Static	Description	W	D	H	MFC Price		
2SD6M	2SD6S	2 drawer	340	x 600	x 727	£469	↑↓	
3SD6M	3SD6S	3 drawer	340	x 600	x 727	£446		
4SD6M	4SD6S	4 drawer	340	x 600	x 727	£469		

### 600mm Deep Desk High - Extended top

Mobile	Static	Description	W	D	H	MFC Price		
3D68M	3D68S	3 drawer	430	x 800	x 727	£483	↔	

### 800mm Deep Desk High

Mobile	Static	Description	W	D	H	MFC Price		
2D8M	2D8S	2 drawer	430	x 800	x 727	£593	↔	
3D8M	3D8S	3 drawer	430	x 800	x 727	£567		
4D8M	4D8S	4 drawer	430	x 800	x 727	£593		

Storage

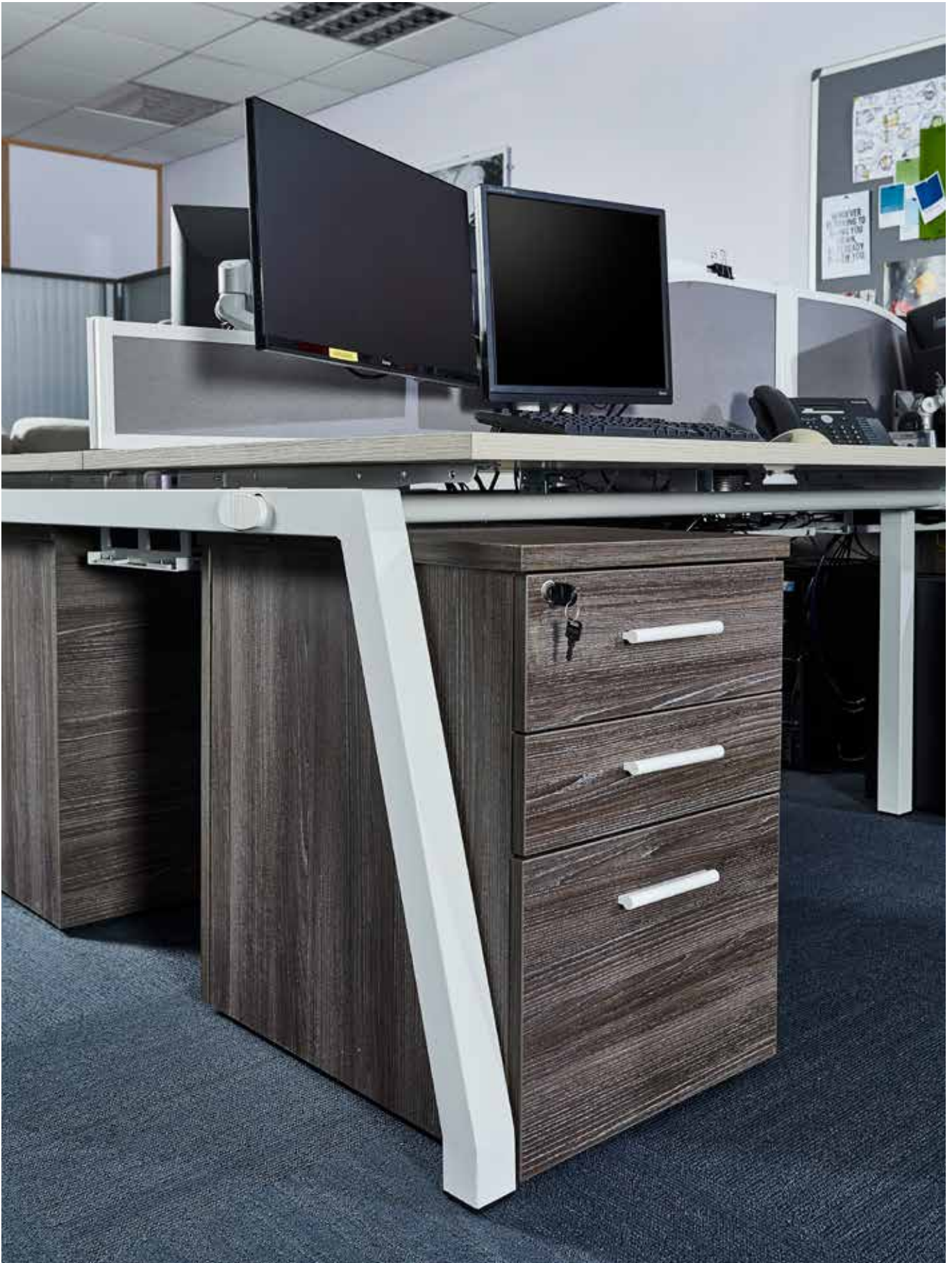

Tall Under Desk Pedestal with Type D Handles

# PEDESTALS & STORAGE UNITS

## STORAGE

10 Year Guarantee

- Fly over top pedestals extend worksurfaces and can convert desks into workstations.
- File hutches utilise above desk space for file storage.



Base code	Description	W	D	H	MFC Price					
<b>Fly Over Top - For use with Rectangular Desk</b>										
3DFSL	Left hand	1000	x	600	x	727	£560	 Left hand	 Right hand	 Left hand shown
3DFSR	Right hand	1000	x	600	x	727	£560			
<b>Fly Over Top - For use with Wave Desk</b>										
3DFWL	Left hand	1000	x	600	x	727	£560	 Left hand	 Right hand	 Left hand shown
3DFWR	Right hand	1000	x	600	x	727	£560			
<b>Fly Over Top - For use with Angular Desk</b>										
3DFAL	Left hand	1000	x	600	x	727	£560	 Left hand	 Right hand	 Left hand shown
3DFAR	Right hand	1000	x	600	x	727	£560			
<b>Rear Fitting 3 Drawer Pedestal &amp; File Hutch</b>										
3D8RH	800 deep	430	x	800	x	1107	£734	 800 deep	 600 deep	
3D6RH	600 deep	430	x	600	x	1107	£591			
File hutch accepts A4 & Foolscap lever arch files & box files.										
<b>Side Fitting 3 Drawer Pedestal &amp; File Hutch</b>										
3D8SH	800 deep	430	x	800	x	1107	£755	 800 deep	 600 deep	
3D6SH	600 deep	430	x	600	x	1107	£626			
File hutch accepts A4 & Foolscap lever arch files & box files.										
<b>800mm Deep Desk High Combination - Lockable Hinged Door</b>										
CP84L	Left hand	430	x	800	x	727	£568	 Left hand	 Right hand	
CP84R	Right hand	430	x	800	x	727	£568			
CP83L	Left hand	340	x	800	x	727	£568			
CP83R	Right hand	340	x	800	x	727	£568			
Supplied with adjustable shelf.										
<b>600mm Deep Desk High Combination - Single Lockable Hinged Door</b>										
CP64L	Left hand	430	x	600	x	727	£485	 Left hand	 Right hand	
CP64R	Right hand	430	x	600	x	727	£485			
CP63L	Left hand	340	x	600	x	727	£485			
CP63R	Right hand	340	x	600	x	727	£485			
Supplied with adjustable shelf.										





Tall Under Desk Pedestal

Base code	Description	W	D	H	MFC Price
-----------	-------------	---	---	---	-----------

**800mm Deep Desk High Combination - Open Fronted**

BCOP84Z	Open front	430	x	800	x	727	£488
BCOP83Z	Open front	340	x	800	x	727	£488

Supplied with adjustable shelf.



**600mm Deep Desk High Combination - Open Fronted**

BCOP64Z	Open front	430	x	600	x	727	£410
BCOP63Z	Open front	340	x	600	x	727	£410
BPU64Z	Open front	430	x	600	x	625	£410
BPU63Z	Open front	340	x	600	x	625	£410

Supplied with adjustable shelf.



### Pen Trays

Code	Description	Price
SLPT	Black only - slide out pen tray. Fits to underside of desk top.	£54
P/TRAY	Black only - suitable for all pedestals except slim-line	£22
S/TRAY	Black only - suitable for slim-line	£29

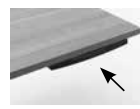

SLPT



SLPT

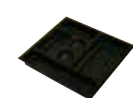

S/TRAY



P/TRAY

System storage is available in hinged door, vertical tambour, side opening and open fronted variations.

Each accept a comprehensive range of fitments to suit your storage needs.

- Tambour units have integral handles as part of the doors.
- Vertical tambour have additional finger-pull section to aid opening.
- Accessories to be ordered separately.



Base code	Description	W		D		H	MFC Price
<b>Cupboard with Hinged Doors</b>							
HD86	Standard	950	x	520	x	2207	£1,079
HD79	Standard	950	x	520	x	2007	£928
HD72	Standard	950	x	520	x	1837	£770
HD56	Standard	950	x	520	x	1607	£620
HD48	Standard	950	x	520	x	1227	£564
HD40	Standard	950	x	520	x	1007	£534
HD29	Standard	950	x	520	x	727	£503
HD296	600mm ext top	950	x	600	x	727	£553
HD298	800mm ext top	950	x	800	x	727	£567

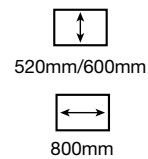

### Wardrobe Conversion - Supplied with 4 Shelves and 1 Coat Rail

Can not be used with vertical tambour cupboards

WC86	2207 High cupboard	862	x	426	x	2112	£411
WC79	2007 High cupboard	862	x	426	x	1912	£384
WC72	1837 High cupboard	862	x	426	x	1744	£351
WC56	1607 High cupboard	862	x	426	x	1514	£323



### Cupboard with Open Front

OF86Z	Standard	950	x	520	x	2207	£620
OF79Z	Standard	950	x	520	x	2007	£564
OF72Z	Standard	950	x	520	x	1837	£500
OF56Z	Standard	950	x	520	x	1607	£435
OF48Z	Standard	950	x	520	x	1227	£376
OF40Z	Standard	950	x	520	x	1007	£346
OF29Z	Standard	950	x	520	x	727	£311
OF29EZ	600mm ext top	950	x	600	x	727	£363
OF29EEZ	800mm ext top	950	x	800	x	727	£384

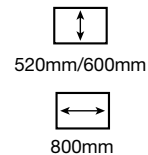

### Cupboard with Side Opening Tambour Door -

Please specify tambour colour - Black, Grey, Silver or White  
Does not require handles.

SUST79Z	Standard	1100	x	520	x	2007	£1,184
SUST72Z	Standard	1100	x	520	x	1837	£992
SUST56Z	Standard	1100	x	520	x	1607	£831
SUST48Z	Standard	1100	x	520	x	1227	£770
SUST40Z	Standard	1100	x	520	x	1007	£742
SUST29Z	Standard	1100	x	520	x	727	£710
SUST29EZ	600mm ext top	1100	x	600	x	727	£768
SUST29EEZ	800mm ext top	1100	x	800	x	727	£782

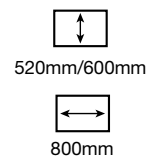

### Cupboard with Vertical Opening Tambour Door -

Please specify tambour colour - Black, Grey, Silver or White  
Does not require handles.

TS86Z	Standard	950	x	520	x	2207	£1,282
TS79Z	Standard	950	x	520	x	2007	£1,091
TS72Z	Standard	950	x	520	x	1837	£938
TS56Z	Standard	950	x	520	x	1607	£790
TS48Z	Standard	950	x	520	x	1227	£731
TS40Z	Standard	950	x	520	x	1007	£703



**Accessories (Black metalwork only)**



**CSLF**  
Combi shelf  
790mm of A4 or foolscap  
filing also accepts 275 or  
330 lateral files

£74



**ROSF**  
Roll out suspension frame  
780mm of A4 or foolscap  
filing

£139



**ROD**  
Roll out drawer  
809mm x 387mm x 105mm

£162



**ROSD**  
Roll out slotted drawer with  
5 dividers  
809mm x 387mm x 105mm

£213



**ASM**  
Adjustable slotted metal  
shelf with 5 dividers  
868mm x 410mm x 155mm

£144



**ALFR**  
Adjustable lateral filing rail  
790mm of lateral filing  
accepts 275 or 330 lateral  
files

£62



**MROS**  
Metal roll out shelf  
870mm x 410mm x 20mm

£98



**AWSZ**  
Adjustable shelf, 25mm  
thick MFC  
868mm x 418mm x 25mm

£46



**AMS**  
Adjustable shelf - Metal  
870mm x 410mm x 20mm

£64



**WHSZ**  
Wooden hat shelf & coat  
rail, 25mm thick MFC  
868mm x 418mm x 25mm

£144



Side Opening Tambour Door

# SYSTEM CAPACITY PLANNING

## STORAGE

Please note: the below capacities are to be used as a guide and are for reference only.

--- Denotes vertical tambour limit.

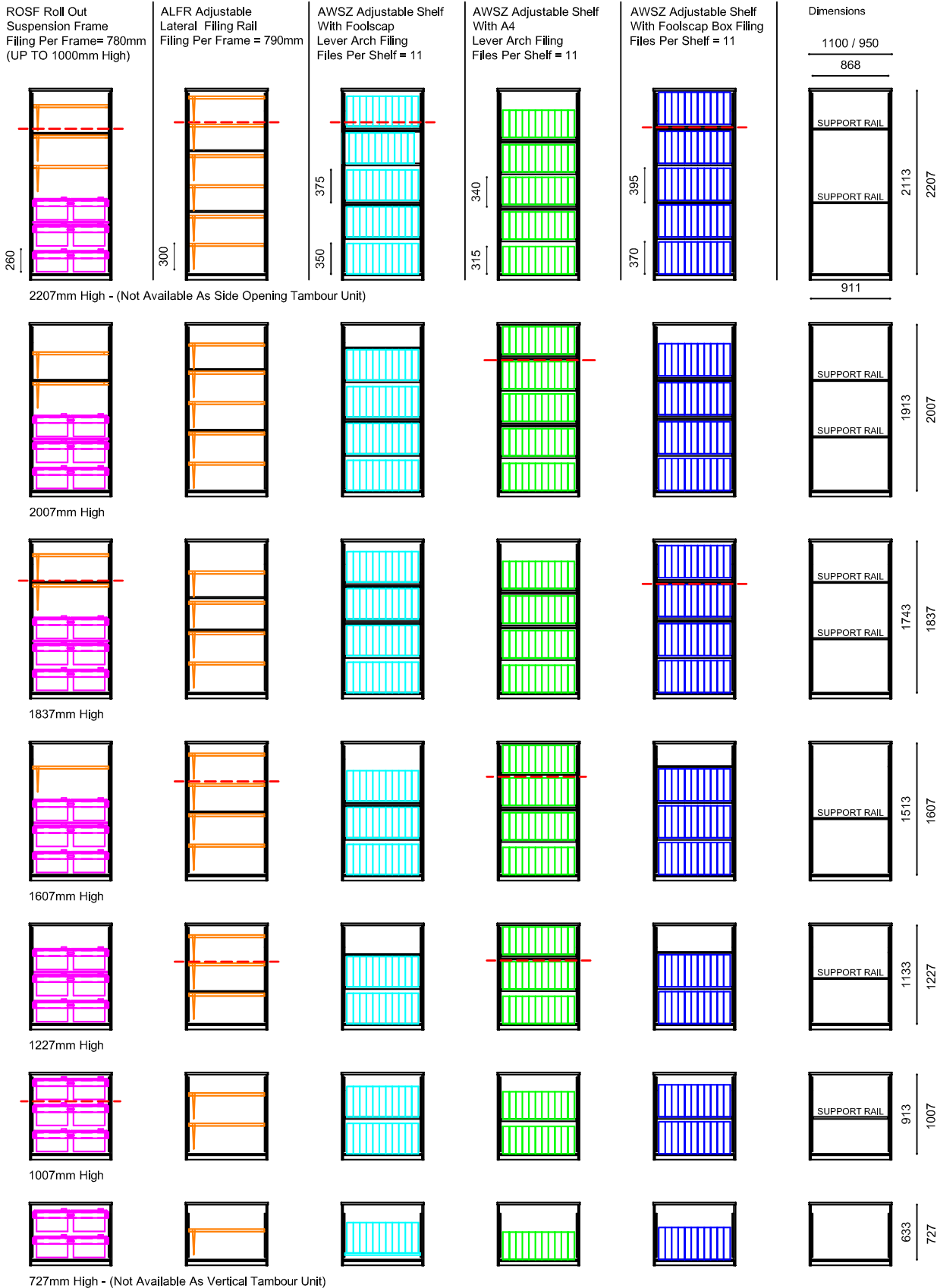

Storage

BOF unit shelf positions (shown with optional HD1 doors)

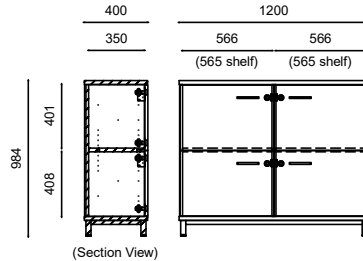
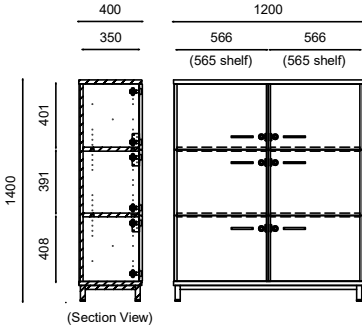
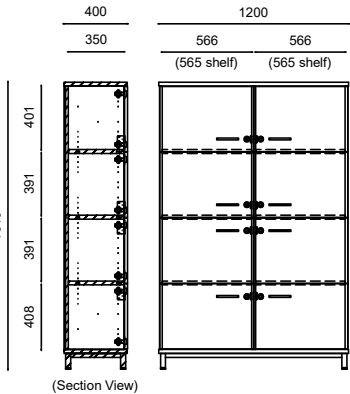

BOF unit shelf positions (shown with optional HD1 doors)

Optional BAWSZ positions when used with optional post door sets (HDPL/HDPR)

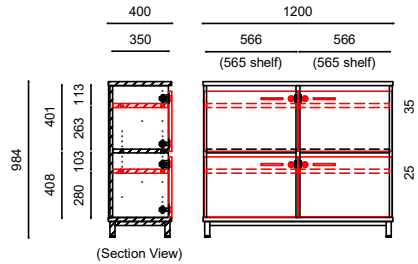
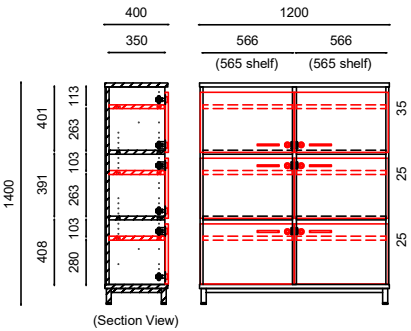
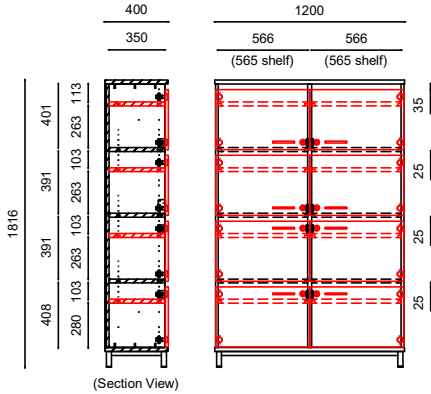

Credenza Unit Specification

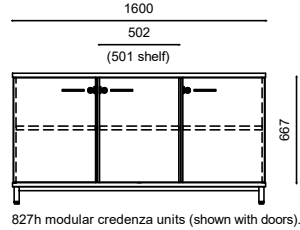
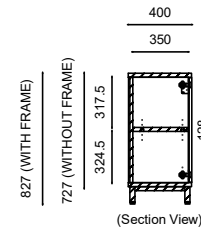
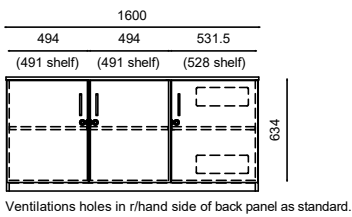
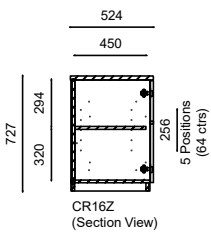

Pigeon Hole Top Unit Specification

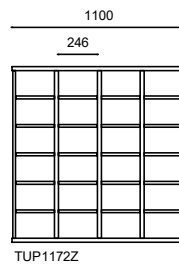
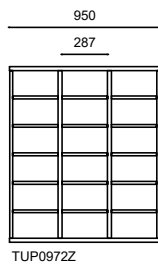
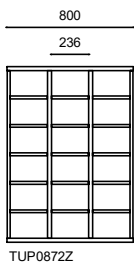
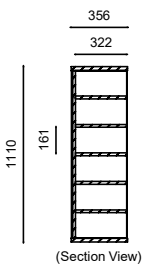
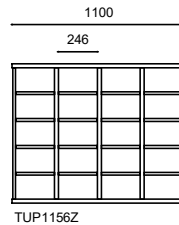
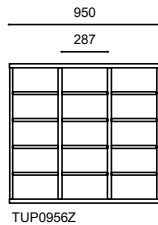
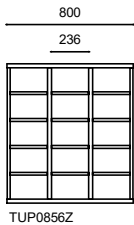
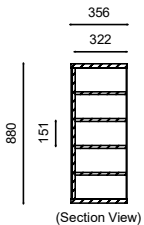

# CABINETS & UNITS STORAGE

10 Year  
Guarantee

Filing storage is based around foolscap sizes and allows users to use filing pockets to hold documents.

- Filing drawers include anti-tilt mechanisms as standard.



Code	Description	W	D	H	MFC Price
<b>Filing Cabinets</b>					
515mm of foolscap filing per drawer.					
FC4	4 Drawer	480	x 600	x 1352	£723
FC3	3 Drawer	480	x 600	x 1037	£588
FC2	2 Drawer	480	x 600	x 727	£500
FC28	2 Drawer ext top	480	x 800	x 727	£534



600mm



800mm



## 950mm Wide 3 Drawer Side Filing Units

770mm of foolscap filing per drawer.

SFU93	Standard	950	x 520	x 1017	£1,059
-------	----------	-----	-------	--------	--------



520mm/600mm



800mm

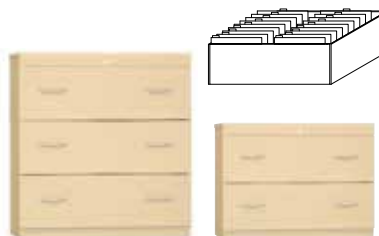

## 950mm Wide 2 Drawer Side Filing Units

770mm of foolscap filing per drawer.

SFU9	Standard	950	x 520	x 727	£750
SFU96	600mm ext top	950	x 600	x 727	£809
SFU98	800mm ext top	950	x 800	x 727	£823

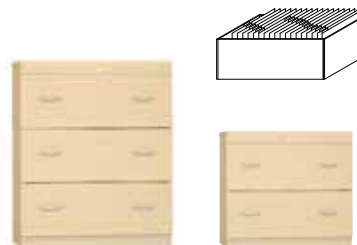

## 800mm Wide 3 Drawer Side Filing Units

690mm of foolscap filing per drawer.

SFU83	Standard	800	x 520	x 1017	£1,031
-------	----------	-----	-------	--------	--------



520mm/600mm



800mm

## 800mm Wide 2 Drawer Side Filing Units

690mm of foolscap filing per drawer.

SFU8	Standard	800	x 520	x 727	£731
SFU86	600mm ext top	800	x 600	x 727	£786
SFU88	800mm ext top	800	x 800	x 727	£796

## Desk High Lockable Double Door Storage Units

800mm wide units supplied with adjustable wooden shelf.  
1200mm wide units supplied with central divider with one adjustable wooden shelf each side.

SU12DZ	Standard	1200	x 520	x 727	£790
SU126DZ	600mm ext top	1200	x 600	x 727	£836
SU128DZ	800mm ext top	1200	x 800	x 727	£863
HD31	Standard	800	x 520	x 727	£520
HD316	600mm ext top	800	x 600	x 727	£568
HD318	800mm ext top	800	x 800	x 727	£580



520mm/600mm



800mm



## Open fronted unit

800mm wide units supplied with adjustable wooden shelf.  
1200mm wide units supplied with central divider with one adjustable wooden shelf each side.

SU12Z	Standard	1200	x 520	x 727	£517
SU126Z	600mm ext top	1200	x 600	x 727	£577
SU128Z	800mm ext top	1200	x 800	x 727	£591
SU31Z	Standard	800	x 520	x 727	£340
SU31EZ	600mm ext top	800	x 600	x 727	£387
SU31EEZ	800mm ext top	800	x 800	x 727	£396



520mm/600mm



800mm



800mm wide unit

10 Year  
Guarantee

## CABINETS & UNITS STORAGE



Storage

Desk High Lockable Double Door Storage, Cupboard with Hinged Doors and Vertical Tambour Unit

# TOP & BASE UNITS STORAGE

10 Year  
Guarantee

By adding top units to base units, simple combination storage can be created. Top shelving units can also be fitted to System Storage, so increasing the possibilities.

- Top units available with open fronts or sliding glass doors.
- Base units match the height of desking and can be used as desk end storage.



Code	Description	W	D	H	MFC Price
------	-------------	---	---	---	-----------

### 950mm Wide Top Units

Supplied with adjustable wooden shelf. Accepts 2 rows of foolscap box files.

TUO29Z	Open fronted	950	x	350	x	887	£326
TUG29Z	Glass doors	950	x	350	x	887	£473



### 800mm Wide Top Units

Supplied with adjustable wooden shelf. Accepts 2 rows of foolscap box files.

QTUO08Z	Open fronted	800	x	350	x	887	£316
QTUG08Z	Glass doors	800	x	350	x	887	£465



### Sliding Door Lock

TUGLK							£55
-------	--	--	--	--	--	--	-----

### 2 Tier Wave Side Opening Tambour Units

Please specify tambour colour - Black, Grey, Silver or White  
Supplied with adjustable wooden shelf. Accepts 2 rows of A4 files.

SUSTWRZ	Right hand	1000	x	600/800	x	727	£982
SUSTWLZ	Left hand	1000	x	600/800	x	727	£982



Left hand shown

### 2 Tier Rectangular Side Opening Tambour Unit

Please specify tambour colour - Black, Grey, Silver or White  
Supplied with adjustable wooden shelf. Accepts 2 rows of A4 files.

SUSTSZ		800	x	600	x	727	£763
--------	--	-----	---	-----	---	-----	------



### 2 Tier Radial Side Opening Tambour Units

Please specify tambour colour - Black, Grey, Silver or White

SURSTRZ	Right hand	800	x	600	x	727	£982
---------	------------	-----	---	-----	---	-----	------



### 2 Tier Wave Open Fronted Unit

Supplied with adjustable wooden shelf. Accepts 2 rows of A4 files.

SUSOWRZ	Right hand	1000	x	600/800	x	727	£638
SUSOWLZ	Left hand	1000	x	600/800	x	727	£638



Left hand shown

### 2 Tier Rectangular Open Fronted Unit

Supplied with adjustable wooden shelf. Accepts 2 rows of A4 files.

SUSOSZ		800	x	600	x	727	£498
--------	--	-----	---	-----	---	-----	------





10 Year  
Guarantee

## TOP & BASE UNITS STORAGE

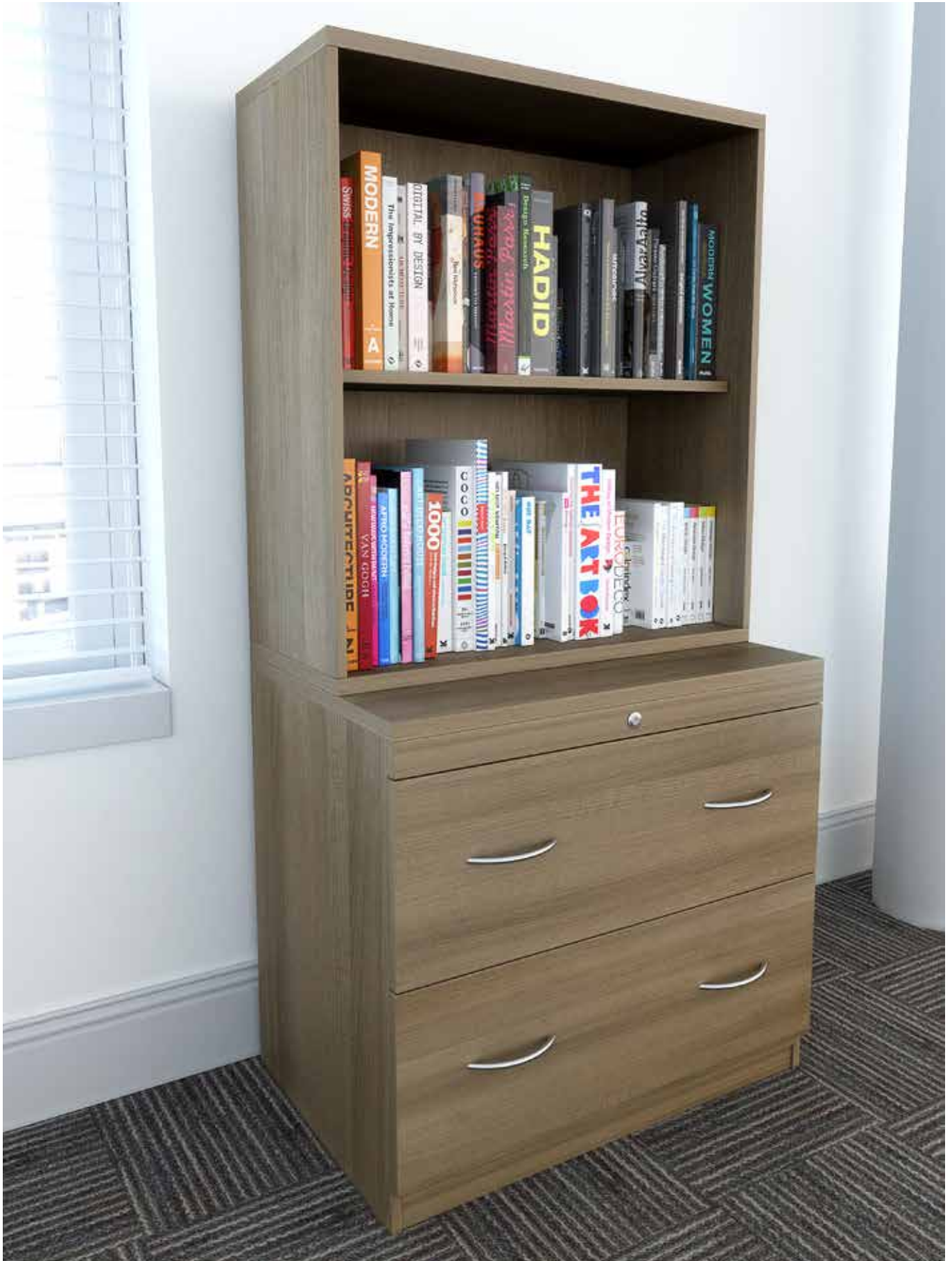

Storage

2 Drawer Side File Unit with Open Fronted Top Unit

# BOOKCASES & PIGEON HOLE UNITS STORAGE



Though each unit has adjustable shelves, each tier is normally based on fooscap box file dimensions. Pigeon Hole units are designed to sit on 'Base' storage units.

- Pigeon Hole units match System Storage heights when fitted to base units.
- 'SU' units are desk height and can be used to extend worksurfaces.

Code	Description	W		D		H	MFC Price
------	-------------	---	--	---	--	---	-----------

### Radial Bookcases

Accepts 2 rows of A4 files.

SURZ	2 tier	800	x	800	x	727	£415
SUR6Z	2 tier	600	x	600	x	727	£388



SUR86RZ	2 tier	800	x	600	x	727	£415
SUR86LZ	2 tier	800	x	600	x	727	£415

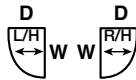

### Desk High Bookcase

Accepts 2 rows of A4 files.

SUB16Z*	2 Tier	1600	x	320	x	727	£552
SUB12Z*	2 Tier	1200	x	320	x	727	£465
SUB10Z	2 Tier	1000	x	320	x	727	£385
SUB08Z	2 Tier	800	x	320	x	727	£302
SUB06Z	2 Tier	600	x	320	x	727	£278

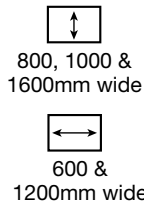

\* with central divider

Please note, Desk High Bookcases have fixed shelves

### Open Fronted Bookcase Shelving

Accepts rows of A4 / fooscap lever arch & box files. 760mm per shelf. \*B5Z requires wall fixing for stability. Shelves adjustable on 64mm centres - 5 positions.

B5Z*	5 Tier	800	x	320	x	2120	£615
B4Z	4 Tier	800	x	320	x	1710	£526
B3Z	3 Tier	800	x	320	x	1300	£435
B2Z	2 Tier	800	x	320	x	890	£326



### Bookcase Shelving with Locking Doors

Accepts rows of A4 / fooscap lever arch & box files. 760mm per shelf. \*requires wall fixing for stability. Shelves adjustable on 64mm centres - 5 positions.

B5DZ*	5 Tier	800	x	350	x	2120	£1,070
B4DZ*	4 Tier	800	x	350	x	1710	£798
B3DZ*	3 Tier	800	x	350	x	1300	£629
B2DZ*	2 Tier	800	x	350	x	890	£530



BWFB	Wall fixing bracket						£26
------	---------------------	--	--	--	--	--	-----



### Pigeon Hole Top Units

1607 high when placed on 727 base unit. Shelves supplied loose.

TUP1156Z	20	1100	x	350	x	880	£849
TUP0956Z	15	950	x	350	x	880	£697
TUP0856Z	15	800	x	350	x	880	£670



1837 High placed on 727 Base Unit. Shelves supplied loose.

TUP1172Z	24	1100	x	350	x	1110	£898
TUP0972Z	18	950	x	350	x	1110	£732
TUP0872Z	18	800	x	350	x	1110	£703

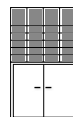

Indicative image shown

10 Year  
Guarantee

# BOOKCASES & PIGEON HOLE UNITS STORAGE



Storage

Open Fronted Bookcase Shelving

# MODULAR STORAGE



Modular Storage is simple shelving units that can be specified as either open fronted or with a combination of lockable doors to suit the users' needs.



- Wooden doors have a suited key system with optional master keys.

Code	Compartments	W	D	H	MFC Price
<b>Open Fronted Storage Units</b>					
Compartment dimensions 390h x 566w x 350d					
BOF18Z	8	1200	x 400	x 1816	£661
BOF14Z	6	1200	x 400	x 1400	£456
BOF10Z	4	1200	x 400	x 984	£353



## Hinged Locking Wooden Doors - Sold separately

HD4	4 Tier door set	1186	x 18	x 1660	£278
HD3	3 Tier door set	1186	x 18	x 1244	£187
HD2	2 Tier door set	1186	x 18	x 828	£120
HD1	1 Tier door set	1186	x 18	x 412	£96



Storage



8 Compartment Storage Units with Wooden 1 & 2 Tier Hinged Doors

10 Year Guarantee

### Single Locking Post Wooden Door Set - Sold separately

Designed to allow envelopes & small packages to be pushed into cupboard.  
Recommended that extra wooden shelf be used - See below

							Price
HDPL	Left hand	1186	x	18	x	380	£66
HDPR	Right hand	1186	x	18	x	380	£66



BAWSZ	Wooden shelf 25mm thick	560	x	320	x	25	£39
-------	----------------------------	-----	---	-----	---	----	-----



### Hinged Non Locking Frosted Glass doors - Sold separately

GHD2	2 tier door set	1186	x	6	x	828	£423
GHD1	1 tier door set	1186	x	6	x	412	£306



### Hinged Non Locking Clear Glass doors - Sold separately

GHD2C	2 tier door set	1186	x	6	x	828	£423
GHD1C	1 tier door set	1186	x	6	x	412	£306

### Arrangements

A selection of storage:  
Units configurations  
showing alternative  
door arrangements.



4 Compartment Storage Units and 6 Compartment Storage Unit with Wooden 1 Tier Hinged Doors

# MODULAR CREDENZAS & MOBILE UNITS STORAGE

















10 Year Guarantee

Modular Storage Credenzas are simple shelving units that can be specified as either open fronted or with a combination of doors to suit the users' needs.



- Credenza units are desk height when steel frames are removed.
- Wooden doors are lockable.

## Credenza Style Storage:



Supplied with 3 shelves. When used without frames units are desk height.

Code	Description	W	D	H	MFC Price		
CW316	3 Wooden Door Unit Lockable	1600	x 400	x 827	£710		
CG316	3 Frosted Glass Door Unit	1600	x 400	x 827	£1,271		
CG316C	3 Clear Glass Door Unit	1600	x 400	x 827	£1,271		
BCR16Z	Open Fronted Unit	1600	x 400	x 827	£510		
CW216	2 Wooden Door Unit Lockable	1600	x 400	x 827	£642		
CG216	2 Frosted Glass Door Unit	1600	x 400	x 827	£1,005		
CG216C	2 Clear Glass Door Unit	1600	x 400	x 827	£1,005		
CR165	3 Wooden Door Unit Lockable	1600	x 520	x 727	£840		

## Mobile Under Desk Unit

BMOF10	Open Unit	1000	x 400	x 625	£434		
BMOF08	Open Unit	800	x 400	x 625	£392		
BMOF06	Single Opening Unit	600	x 400	x 625	£365		

## Mobile Under Desk Unit with Locking Doors

MHD10	Hinged Doors	1000	x 400	x 625	£567		
MHD08	Hinged Doors	800	x 400	x 625	£510		
MHD06L	Single Left Door Unit	600	x 400	x 625	£483		
MHD06R	Single Right Door Unit	600	x 400	x 625	£483		

## Optional Upholstered Seat Cushion - Band 1

Fits to top of Under Desk Units to provide perching area

UPSC10		1000	x 400	x 50	£189		
UPSC08		800	x 400	x 50	£151		
UPSC06		600	x 400	x 50	£114		

Unit not included

10 Year  
Guarantee



Storage

2 Wooden Door Credenza Unit

# Kulture



Kulture Quoll Cupboards come in four optional sizes. You can assemble display units or top units on top of them and in doing so create a simple and adaptable combination storage, thereby making best use of your workspace.



**KQ12PLST**  
Plinth  
W1200 x D400 x H135  
£308

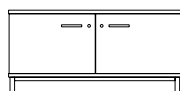

**KQ1206ST**  
Low Storage Unit  
W1200 x D400 x H615  
£413

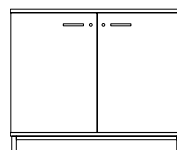

**KQ1210ST**  
Tall Storage Unit  
W1200 x D400 x H995  
£473



**KQ08PLST**  
Plinth  
W800 x D400 x H135  
£289

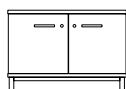

**KQ0806ST**  
Low Storage Unit  
W800 x D400 x H615  
£391

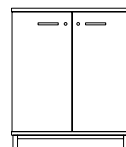

**KQ0810ST**  
Tall Storage Unit  
W800 x D400 x H995  
£437







# KULTURE QUOLL STORAGE

Style meets flexibility in the new Kulture range from Gresham. Designed to support the dynamic, ever-changing workplace, each item is modular and re-configurable to suit your changing needs. The versatility in the design is endless; as items can be built in any number of combinations. The range is ideal for the modern workspace as agile and activity-based working practices continue to evolve.



**KQSHelf**  
Shelf  
W370 x D361  
£40



**KQBOX**  
Box  
W370 x D361 x H376  
£204

Storage



Kulture Quoll & Capaldi

# Kulture



Totally re-configurable, the cube-shaped units allow you to adapt the size and shape of your storage as your workspace changes.



**KQ1W1H**  
1 Wide x 1 High Unit  
W408 x D398 x H398  
£424



**KQ1W2H**  
1 Wide x 2 High Unit  
W408 x D398 x H777  
£629



**KQ1W3H**  
1 Wide x 3 High Unit  
W408 x D398 x H1157  
£831



**KQ1W4H**  
1 Wide x 4 High Unit  
W408 x D398 x H1537  
£1,031



**KQ1W5H**  
1 Wide x 5 High Unit  
W408 x D398 x H1916  
£1,234



**KQ2W1H**  
2 Wide x 1 High Unit  
W797 x D398 x H398  
£669

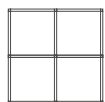

**KQ2W2H**  
2 Wide x 2 High Unit  
W797 x D398 x H777  
£997



**KQ2W3H**  
2 Wide x 3 High Unit  
W797 x D398 x H1157  
£1,327

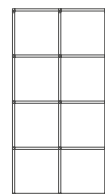

**KQ2W4H**  
2 Wide x 4 High Unit  
W797 x D398 x H1537  
£1,653



**KQ2W5H**  
2 Wide x 5 High Unit  
W797 x D398 x H1916  
£1,982





# Kulture



Totally re-configurable, the cube-shaped units allow you to adapt the size and shape of your storage as your workspace changes.

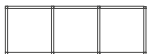

**KQ3W1H**  
3 Wide x 1 High Unit  
W1187 x D398 x H398  
£915

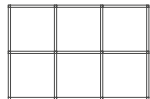

**KQ3W2H**  
3 Wide x 2 High Unit  
W1187 x D398 x H777  
£1,367

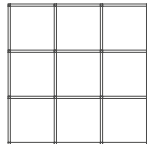

**KQ3W3H**  
3 Wide x 3 High Unit  
W1187 x D398 x H1157  
£1,821

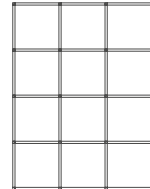

**KQ3W4H**  
3 Wide x 4 High Unit  
W1187 x D398 x H1537  
£2,276

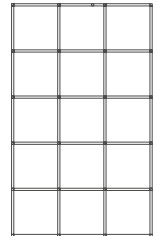

**KQ3W5H**  
3 Wide x 5 High Unit  
W1187 x D398 x H1916  
£2,730

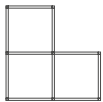

**KQ2W2HST**  
2 Wide x 2 High Step Unit  
W797 x D398 x H777  
£880

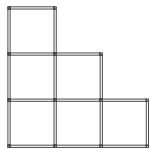

**KQ3W3HST**  
3 Wide x 3 High Step Unit  
W1187 x D398 x H1157  
£1,457

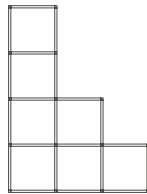

**KQ3W4HST**  
3 Wide x 4 High Step Unit  
W1187 x D398 x H1537  
£1,660

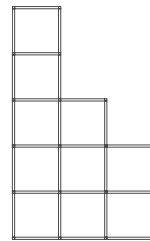

**KQ3W5HST**  
3 Wide x 5 High Step Unit  
W1187 x D398 x H1916  
£2,114

Storage



# PLANTERS STORAGE

NEW  
ADDITION

10 Year  
Guarantee

In keeping with the biophilic trend, bring the outdoors in. Create a calming aesthetic and add colour to your interiors.



- Non-irrigated plant holder
- For use with standard storage units

Code	Dimensions			MFC Price
	W	D	H	
PLANT1	800	x 320	x 200	£156
PLANT2	1600	x 400	x 200	£182



Storage



Planter on a 2 Wooden Door Credenza Unit

10 Year  
Guarantee

# STEEL/MFC UNITS & LOCKERS STORAGE



Storage



Steel and MFC Lockers

# INTRODUCTION

## BESPOKE



Bespoke



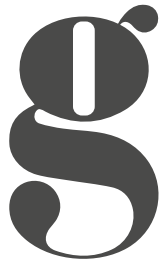

GRESHAM  
BESPOKE

## FROM CONCEPT TO COMPLETION

Gresham Bespoke design everything from scratch, starting with the earliest concept sketches through to the installation of our completed products.

From detailed technical drawings we can manufacture and construct every component of a project on site, including meticulous testing and trialling to meet a briefs' specifications. This ensures that we only ever deliver the highest standard of quality bespoke products, that always stand the tests of time.



Bespoke



# OUR PROCESS

## BESPOKE

'The Devil is in the detail' and when supplying tailored solutions, it's all about getting every aspect right to meet your needs, in the timescales that suit you and at the right price.

### Client Requirement



1

Though we offer a huge selection of products within our standard portfolio, there's always a time when something different is required. This is where we listen to you and find out what you or your team need. This is where the wish list can be fine-tuned.

### Concepts

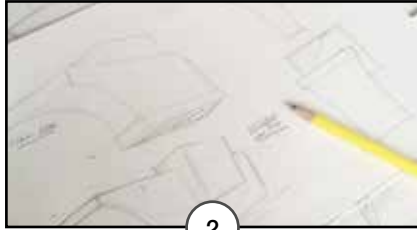

2

Whether starting from 'set-in-stone' specifications or a clean piece of paper, we discuss your requirements with you, offer advice and can quickly determine whether the solutions need to go down our 'Specials' or 'Bespoke' route; offering alternatives where possible. These can be simply illustrated to help communicate the ideas and formulate the plan of action.

### Design and CGI



3

Once agreed, we develop the ideas into detailed designs that will meet all exacting standards. We understand, however, that some things are difficult to imagine, so as part of our service we can produce computer generated images of the suggested products shown in detail or placed within your workspace. Colours, textures, shapes and scale can all be shown, bringing the whole concept to life.

### Site Template



4

We appreciate that real life can differ from concept, so when needed, members of our specialist team will visit site to confirm measurements or produce templates for manufacturing parts to ensure an exact fit during the installation phase. It's all about getting it right!

### Manufacture



5

Being able to draw upon our design experience, state-of-the-art manufacturing facility and combining this with our hand-crafted joinery expertise enables us to work with an enormous array of materials and processes. This allows us to turn those concepts into reality.

### Installation



6

Whether it's a simple drop-off on site or a complete fitted solution, it's all part of our complete service in supporting you. It doesn't stop there either. If needed, once the furniture is installed we can offer user guides and explanations to ensure each user benefits from the experience.

Bespoke





# CASE STUDY

## BESPOKE



Bespoke

# FINISHES & ADDITIONS

## BESPOKE

We work closely with Architects, Designers & End users to help choose and specify finishes taking into consideration: Design, Manufacturing process, Durability & Budget.

### Gresham Standard MFC



Standard range of finished available in 18mm, 25mm & 36mm thick board. ABS edging is available either 1mm or 2mm thick in a matching finish or Multiplex. Refer to the Gresham Product Guide for available MFC finishes. Samples can be requested by contacting your account manager or our sales department.

### Gresham Standard High Pressure Laminate



Matching laminate finishes that complement our standard MFC range. The core material is MDF, available with ABS edging at 1mm or 2mm thick with a matching finish or Multiplex. Refer to the Gresham Product Guide for available laminate finishes. Samples can be requested by contacting your account manager or our sales department.

### Non Standard High Pressure Laminate



We offer hundreds of finishes from a range of manufacturers including plain colours, wood grain effect, textured finish, matt, high gloss, patterned and metallic finishes. Due to the wide range available, we do not hold samples in stock but they can be requested direct from the manufacturer. Alternatively email [bespoke@gof.co.uk](mailto:bespoke@gof.co.uk) to request samples on your behalf.

### Real Wood Veneer



We can select veneers with unique grain patterns to suit individual products highlighting the natural beauty of a wood finish. European Oak, Maple, Ash & American Black Walnut are all available. Samples can be requested by contacting your account manager or our sales department.

### Solid Surface



Solid surface is an extremely versatile material that can be shaped and formed with seamless joints using thermoforming. The option for engraving is also available when choosing a solid surface finish. As an approved Corian fabricator we can offer a 10 year guarantee on our products.

### Signage



Units can simply be customized to suit your building and work requirements to feed all the services through the furniture, directly to any reception equipment.

### Glass



We can finish our units with toughened glass. Available as back painted or with coloured film backing, straight or curved.

### Glass Counter



Available as straight or curved units, adding a clear protective layer.

### Glass Front



Connected to Rectangular Base, Block or Hutch adding a touch of finesse.

### Lighting



This subtle addition can highlight kick-plates, counters or recesses. This is supplied in a selection of styles to suit the application.

### Cable Management Tunking and Outlets



This addition can personalise the units, whether fitted to base units or hutches, glass or acrylic panel.

### Feature Inlays



Adding more finesse to standard units, these strips are used to decoratively 'break-up' vertical surfaces and can be colour coordinated to suit with kick-plates.

### Gate and Flap



Used to enclose users whilst providing access when units are adjacent to walls.

# CASE STUDY

## BESPOKE



# CASE STUDY

## BESPOKE

Bespoke



# CASE STUDY

## BESPOKE



Bespoke



# CASE STUDY

## BESPOKE



Bespoke



# CASE STUDY

## BESPOKE



Bespoke



# CASE STUDY

## BESPOKE



Bespoke





# CASE STUDY

## BESPOKE



Bespoke



**CASE STUDY**  
BESPOKE



Bespoke



Bespoke

# CASE STUDY

## BESPOKE



Bespoke

# CASE STUDY BESPOKE



Bespoke

# INTRODUCTION

## TASK & VISITOR



Task & Visitor  
Seating



Selected items within this range are stackable. These items are identified within the product description.

For further information regarding stacking quantity - Please contact our Sales Department.



Items are available in a variety of fabrics. A number of products possess certain upholstery restrictions - these are therefore available in selected fabrics only and are identified within this brochure.

For further information regarding fabric suitability - Please contact our Sales Department.



Arms are available on designated product ranges as indicated within the relevant product thumbnails. Colour / Finish options are indicated on relevant product pages - where applicable.

For further information regarding Arm options - Please contact our Sales Department.



Feet are available on designated product ranges as indicated within the relevant product thumbnails. Colour / Finish options are indicated on relevant product pages - where applicable.

For further information regarding Feet options - Please contact our Sales Department.



Items include Reflex Foam Structure as standard.

Level 'S' tested to BS5459: Part 2: 2000.

Extreme Comfort.

Consistent Shape Retention.

Durability and long life.

Excellent Fire Retardant Properties.

We recommend that you request fabric samples prior to ordering.

Two tone upholstery is available on selected products. Please contact our Sales Department for further information.

You can find dimensions for all products in the technical data section of this brochure.

Please Note: All images shown are for illustrative purposes.

Some aspects of certain products may differ. Please contact our customer services department with any queries.

# TASK SEATING MECHANISMS

## TECHNICAL INFORMATION

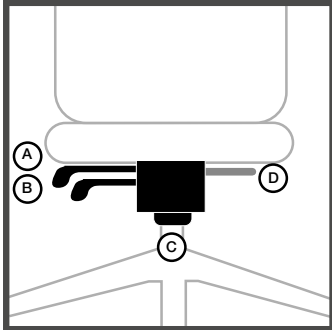

### MECH 2

**Points**  
Synchronized mechanism  
Optional Seat Slide (50 mm movement)

**Operation**  
A - Seat Height Adjustment  
B - Seat & Back Angle Adjustment (Synchronized)  
C - Mechanism Tension Adjustment  
D - Seat Depth Adjustment (Optional)

**Used On**  
Platinum Plus Round  
Platinum Plus Square  
Platinum Ergo  
Platinum Squared

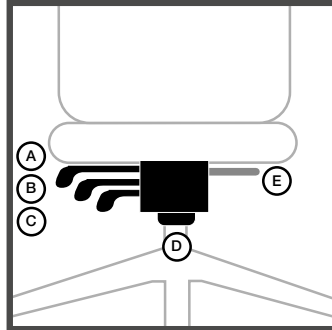

### MECH 3

**Points**  
Independent Seat & Back  
Optional Seat Slide  
Seat slider with 50 mm movement

**Operation**  
A - Seat Height Adjustment  
B - Seat Tilt  
C - Back Angle Adjustment / Lock  
D - Mechanism Tension Adjustment  
E - Seat Depth Adjustment (Optional)

**Used On**  
Platinum Plus Round  
Platinum Plus Square  
Platinum Ergo  
Platinum Squared

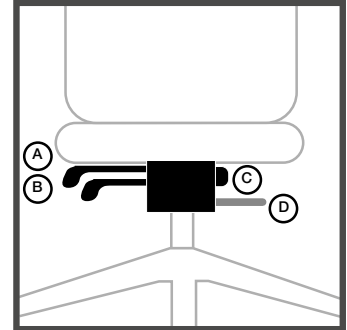

### MECH 4

**Points**  
Fixed Seat  
Optional Seat Slide (50 mm movement)

**Operation**  
A - Seat Height Adjustment  
B - Back Angle Adjustment  
C - Mechanism Tension Adjustment  
D - Seat Depth Adjustment (Optional)

**Used On**  
Adlington  
Adlington Mesh

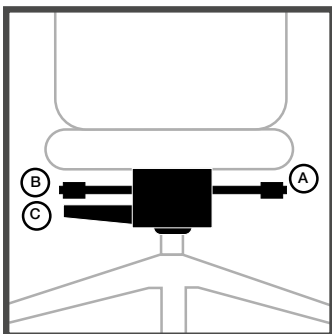

### 24/7 MECH

**Points**  
Synchronized mechanism  
Allows coordinated movement (21° Back / 9° seat)  
5 Lockable Back positions / Safety antishock system  
Seat Slide with 50 mm movement & 5 locking positions

**Operation**  
A - Lever: Lockable Seat Slide / Button: Mechanism Limiter  
B - Lever: Seat Height Adjustment / Button: Lock  
C - Mechanism Tension Adjustment

**Used On**  
Bromley 24/7

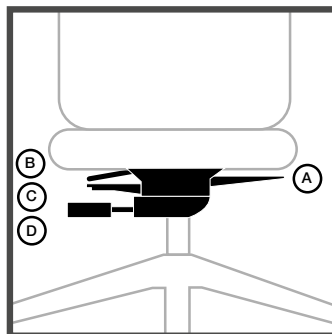

### TO MECH

**Points**  
Synchronized mechanism  
Allows coordinated movement (20.5° Back / 11° seat)  
Lockable in selected position

**Operation**  
A - Mechanism Release Handle / Position Lock  
B - Seat Depth Adjustment  
C - Seat Height Adjustment  
D - Mechanism Tension Adjustment

**Used On**  
Take Off Executive  
Take Off

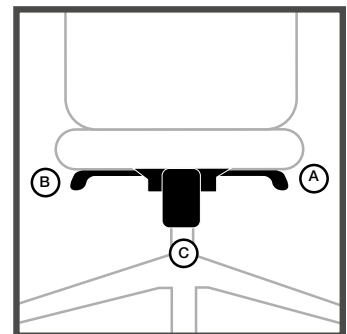

### HQHE / HQME

**Points**  
Knee Tilt  
Back Tension Adjustment

**Operation**  
A - Back / Knee Tilt / Back Angle Lock (Lift)  
B - Seat Height Adjustment  
C - Mechanism Tension Adjustment

**Used On**  
Harlequin Executive



# TASK SEATING MECHANISMS

## TECHNICAL INFORMATION

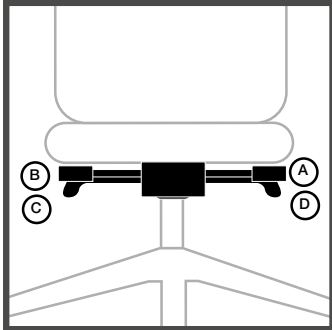

### MECH 7

**Points**  
Synchronized mechanism  
Allows coordinated movement  
5 Lockable Back positions  
Seat Slide with 60 mm movement

**Operation**  
A - Back Adjustment Lock  
B - Back Angle Adjustment Tension  
C - Seat Height Adjustment  
D - Seat Depth Adjustment

**Used On**  
G Series  
G Series Mesh  
Move Up  
Platinum Plus Round  
Platinum Plus Square  
Santis Ergo  
Santis Squared  
Harlequin Mesh

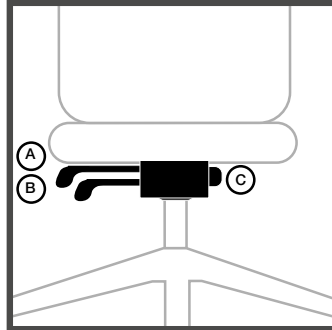

### MECH 8

**Points**  
Fixed Seat  
Optional Seat Slide (50 mm movement)

**Operation**  
A - Seat Height Adjustment  
B - Back Angle Adjustment  
C - Mechanism Tension Adjustment

**Used On**  
Platinum Plus Round  
Platinum Plus Square  
Platinum Ergo  
Platinum Squared

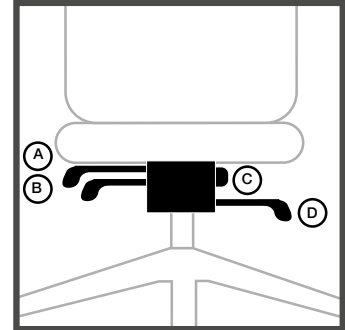

### MECH 9

**Points**  
Independent Seat & Back  
Optional Seat Slide (50 mm movement)

**Operation**  
A - Seat Height Adjustment  
B - Back Angle Adjustment  
C - Mechanism Tension Adjustment  
D - Seat Angle Adjustment

**Used On**  
Adlington  
Adlington Mesh

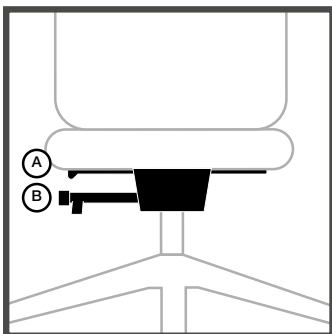

### OSCAR MECH

**Points**  
Self-weighting Synchro  
Allows coordinated movement  
5 Lockable Back positions  
Seat Slide with 65 mm movement

**Operation**  
A - Seat Slide Handle  
B - Seat Height adjustment (Lift paddle)  
Back Angle Adjustment (Twist end)

**Used On**  
Oscar

# TASK SEATING ARMS

## TECHNICAL INFORMATION

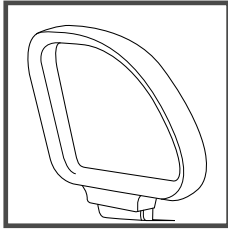

### A2

Black Fixed Arms

**Used On:**  
Platinum Plus Round  
Platinum Plus Square  
Platinum Ergo  
Platinum Squared  
Adlington  
Adlington Mesh

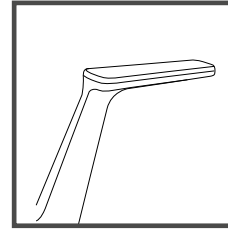

### Alu to Arm

Fixed Polished  
Aluminium  
Arms/PU Pads

**Used On:**  
Take Off Executive

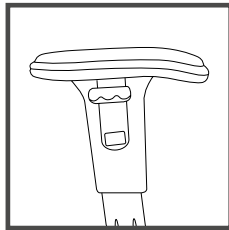

### A8

Black Height  
Adjustable Arms (Lift  
Lever to Adjust Height)

**Used On:**  
Platinum Plus Round  
Platinum Plus Square  
Platinum Ergo  
Platinum Squared  
Platinum Mesh  
Santis Ergo  
Santis Squared  
Adlington  
Adlington Mesh  
Harlequin Mesh

**Adjustment:**

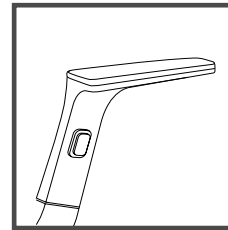

### Blk H/A to Arm

Black Height  
Adjustable Arms/PU  
Pads (Lift Lever to  
Adjust Height)

**Used On:**  
Take Off Executive  
Take Off

**Adjustment:**

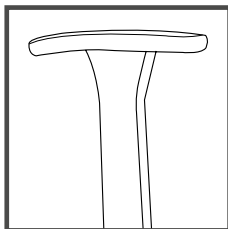

### A1

Black Fixed Arms

**Used On:**  
Santis Ergo  
Santis Squared  
Platinum Mesh

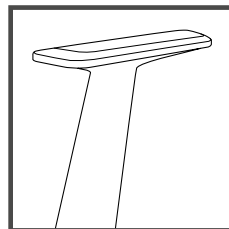

### A23

Black Fixed Arms

**Used On:**  
G Series Fabric  
G Series Mesh  
Move Up

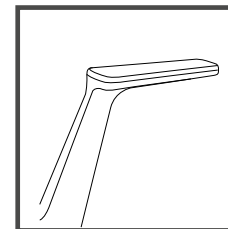

### Blk to Arm

Black Fixed Arms/PU  
Pads

**Used On:**  
Take Off Executive  
Take Off

# TASK SEATING ARMS

## TECHNICAL INFORMATION

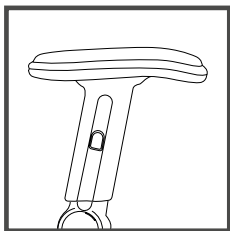

### A13

Height Adjustable & Foldable Arms (Push Button to Adjust Height and Fold)

**Used On:**  
 Platinum Plus Round  
 Platinum Plus Square  
 Platinum Ergo  
 Platinum Squared  
 Platinum Mesh  
 Santis Ergo  
 Santis Squared  
 Adlington  
 Harlequin Mesh

**Adjustment:**

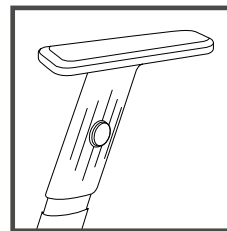

### A24

Height Adjustable Arms (Lift Lever to Adjust Height)

**Used On:**  
 G Series Fabric  
 G Series Mesh  
 Move Up

**Adjustment:**

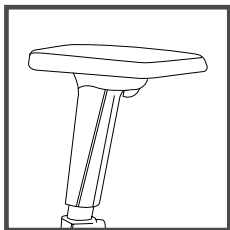

### A4D

4D Multi-function Arms (Push Button to Adjust Height / Move Pad to Adjust Width Depth & Angle)

**Used On:**  
 Platinum Plus Round  
 Platinum Plus Squared  
 Platinum Mesh  
 Santis Ergo  
 Santis Squared

**Adjustment:**

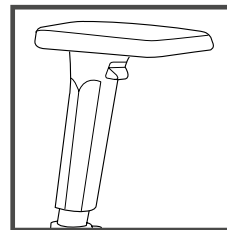

### A25

4D Multi-function Arms (Push Button to Adjust Height / Move Pad to Adjust Width Depth & Angle)

**Used On:**  
 G Series Fabric  
 G Series Mesh  
 Move Up

**Adjustment:**

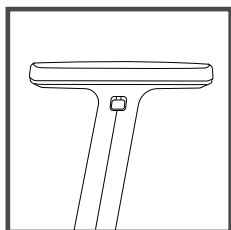

### OSC

Black Height Adjustable Arms/PU Pads (Push Button to Adjust Height)

**Used On:**  
 Oscar

**Adjustment:**

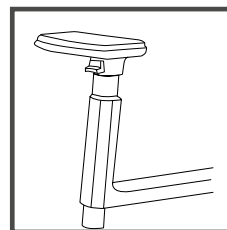

### A22

Multi-function Push Button Arms (Push Button to Adjust Height / Release Lever to Adjust Width / Move Pad to Adjust Depth & Angle)

**Used On:**  
 Bromley 24/7

**Adjustment:**

# OSCAR

DESIGNED BY

**JONES & PARTNERS**

Oscar makes light work of long days at the office. Its sleek, modern styling cleverly hides innovative flexibility: interchangeable backrests that allow you to personalise your chair. Choose from a rainbow of colour options across frame, back panel, optional sprung headrest and seat. Lumbar support comes as standard and it's easy to adjust. Comfortable and dependable, every office needs an Oscar.

Product Features



Optional Extras

H	Sprung Headrest	£80
A	Standard Height Adjustable Arms	£117
D	Soft Castors	£29
E	Brake Unloaded Castors	£29
F	Soft Brake Unloaded Castors	£35
P	Polished Base	£78
M	Multi-functional 4D Arms	£150



How to specify:

	Base Colour	Hub Colour	Body Colour	Trim Colour	Mesh Colour		Optional Extras		
<b>OS</b>						-			
	B=Black	B=Black	B=Black	B=Black	B=Black 60999		A=Standard Height Adjustable Arms		
	G=Grey	G=Grey	G=Grey	G=Grey	G=Graphite 60025		C=Standard Castors		
	P=Polished (Surcharge)	W=White	W=White	O=Orange	L=Light Grey 60165		D=Soft Castors		
	W=White			W=White	O=Orange 63034		E=Brake Unloaded Castors		
				Y=Yellow	U=Blue 66063		F=Soft Brake Unloaded Castors		
					Y=Yellow 68137		H=Headrest		
							N=No Arms required		
							M=Multi-functional 4D Arms		

Example of code: OSBBWBY-AC (Oscar chair with black base, black hub, white body, black trim, yellow mesh with standard height adjustable arms and standard castors).

Visit our website to see the configurator.

Base Colours

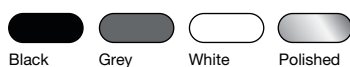

Hub Colours



Body Colours Headrest, Cassette, Lumbar Arch



Trim Colours Plaque, Lumbar Pad



Mesh Colours

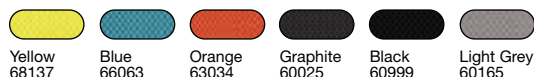

Yellow, Blue & Orange mesh colours are subject to availability. Please contact our Sales Department for further information.



# OSCAR TASK & VISITOR

## Headrest

Spring activated by the user.  
\*Available in Black / Grey / White Frame

## Adjustable Lumbar Support

Lift or lower Lumbar Pad to suit  
(100mm vertical adjustment)  
\*Available in Black / Grey / White /  
Yellow / Orange

## Arms

**Standard Height Adjustable:**  
Press button situated on outer side of arm.  
Lift or lower to suit  
(Adjustable in height – 80mm)

**Multi-functional 4D Arm:**  
Press button situated on outer side to raise or lower arms.  
(Adjustable in height – 80mm)

Press button on inner side of arm pad to move it forward / backwards or side to side.  
(Adjustable front to back – 50mm, each arm adjustable width - 30mm)

## Mechanism

Self - Weighting Synchro

**Height:**  
Lift paddle handle for height adjustment

**Back Travel:**  
Twist end section for 5x back angle travel restriction settings

## Seat Slide

Integrated 5 position Seat Slide located within seat outer plastic (Adjustable in depth - 65mm)

1. Lift and pull handle to operate
2. Whilst applying weight to the seat, move body forward or backwards to suit
3. Release handle to lock



Gabriel Runner 60165 (Mesh) Gabriel Elevation 2602 (Band 2) (Seat)

# OSCAR TASK & VISITOR

5 Year  
Guarantee

## 65mm Castor Options



Standard



Soft



Brake  
Unloaded



Brake  
Unloaded  
Soft

## Dimensions

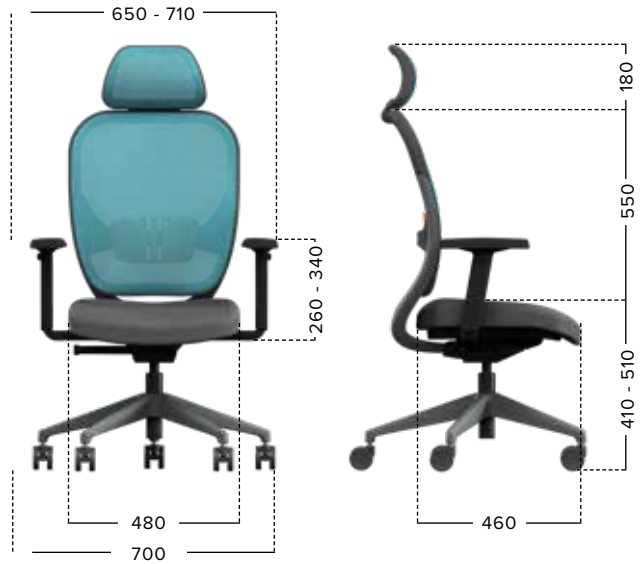

Task & Visitor  
Seating



Gabriel Runner 60999 (Mesh) Gabriel Crisp 04201 (Band 4) (Seat)



# OSCAR TASK & VISITOR

Oscar makes light work of long days at the office. Its sleek, modern styling cleverly hides innovative flexibility.

- Offers optimum back support with interchangeable backrest.
- Suited to intense working environments, which demand prolonged periods of sitting.
- Soft touch mesh.
- Adjustable lumbar pad.
- Synchronized side tension mechanism with seat slide and gas lift height adjustment.
- Multiple colour variations.



OSBBWB-Y-C

Band 1 .....	£624
Band 2 .....	£637
Band 3 .....	£655
Band 4 .....	£668
Band 5 .....	£686
Band 6 .....	£699
Band 7 .....	£717



OSWWWB-C

Band 1 .....	£624
Band 2 .....	£637
Band 3 .....	£655
Band 4 .....	£668
Band 5 .....	£686
Band 6 .....	£699
Band 7 .....	£717



OSBBWYU-C

Band 1 .....	£624
Band 2 .....	£637
Band 3 .....	£655
Band 4 .....	£668
Band 5 .....	£686
Band 6 .....	£699
Band 7 .....	£717



OSGGBL-AC

Band 1 .....	£742
Band 2 .....	£755
Band 3 .....	£774
Band 4 .....	£786
Band 5 .....	£804
Band 6 .....	£819
Band 7 .....	£833



OSWGBYB-AC

Band 1 .....	£742
Band 2 .....	£755
Band 3 .....	£774
Band 4 .....	£786
Band 5 .....	£804
Band 6 .....	£819
Band 7 .....	£833



OSWWGGO-AC

Band 1 .....	£742
Band 2 .....	£755
Band 3 .....	£774
Band 4 .....	£786
Band 5 .....	£804
Band 6 .....	£819
Band 7 .....	£833



OSWWGGU-ACH

Band 1 .....	£821
Band 2 .....	£837
Band 3 .....	£853
Band 4 .....	£866
Band 5 .....	£884
Band 6 .....	£898
Band 7 .....	£917



OSWWGOL-ACH

Band 1 .....	£821
Band 2 .....	£837
Band 3 .....	£853
Band 4 .....	£866
Band 5 .....	£884
Band 6 .....	£898
Band 7 .....	£917



OSBBWL-ACH

Band 1 .....	£821
Band 2 .....	£837
Band 3 .....	£853
Band 4 .....	£866
Band 5 .....	£884
Band 6 .....	£898
Band 7 .....	£917



OSGBOU-ACH

Band 1 .....	£821
Band 2 .....	£837
Band 3 .....	£853
Band 4 .....	£866
Band 5 .....	£884
Band 6 .....	£898
Band 7 .....	£917

Task & Visitor  
Seating

# KEEKO

## TASK & VISITOR SEATING



A technical jewel and object of desire. Keeko is the ergonomically designed task chair that acts like a mirror to adapt to your body. Available in black or white with the option of mesh or fully upholstered backs for maximum comfort. The Keeko task chairs is available in a wide range of fabrics to suit your individual needs.

### Product Features



- Available in black or white
- Soft touch pad
- Injected foam for the seat
- Self-weighting mechanism
- New Klea nylon base
- Reduced aluminium for extreme lightness
- Custom ergonomic armrest positions
- Anti-knee rise
- Independent levers that adjust to your posture



**KEEBM**  
Black Plastic  
with Mesh Back

Band 1 .....	£810
Band 2 .....	£824
Band 3 .....	£844
Band 4 .....	£862
Band 5 .....	£884
Band 6 .....	£902
Band 7 .....	£921
Leather Group 1 .....	POA



**KEEWM**  
White Plastic  
with Mesh Back

Band 1 .....	£810
Band 2 .....	£824
Band 3 .....	£844
Band 4 .....	£862
Band 5 .....	£884
Band 6 .....	£902
Band 7 .....	£921
Leather Group 1 .....	POA



**KEEBF**  
Black Plastic  
with Full Back

Band 1 .....	£762
Band 2 .....	£780
Band 3 .....	£808
Band 4 .....	£829
Band 5 .....	£857
Band 6 .....	£881
Band 7 .....	£904
Leather Group 1 .....	POA



**KEEWF**  
White Plastic  
with Full Back

Band 1 .....	£762
Band 2 .....	£780
Band 3 .....	£808
Band 4 .....	£829
Band 5 .....	£857
Band 6 .....	£881
Band 7 .....	£904
Leather Group 1 .....	POA





# HARLEQUIN EXECUTIVE TASK & VISITOR

Harlequin is a fully upholstered leather executive task chair, ideal for management office and traditional boardroom environments.

- Available in two back heights with gas lift height adjustability.
- Knee tilt and back tension adjustment mechanism.
- Chrome finish as standard.
- Accompanying visitor chair (Chrome Frame).

#### Additional Information

All prices shown below represent Black Leather.  
Batch to batch variations in shade may occur within commercial tolerances.



HQHE-SB1  
High Back with Fixed Arms  
£1,181



HQME-SB1  
Medium Back with Fixed Arms  
£1,012



HQEC-SB1  
Cantilever with Fixed Arms  
£1,009



Shown in black leather - other colours available

# TAKE OFF EXECUTIVE TASK & VISITOR

5 Year  
Guarantee

Take Off Executive is the perfect executive task chair that delivers both dynamism and adaptability.

- Incorporates polished aluminium features.
- Synchronized mechanism with integrated seat slide and polished aluminium base come as standard.
- Ratchet back height adjustment.

**Limited stock available. Please contact our Sales Department for further information.**

## Product Features



## Additional Information

All prices shown below represent Leather Group 1 fabrics. Visitor Chair frame in Chrome.



TO1  
High Back with Headrest  
£1,154



TO2  
High Back with Headrest  
Black Fixed Arms/PU Pads  
£1,223



TO3  
High Back with Headrest  
Fixed Polished Aluminium  
Arms/PU Pads  
£1,345



TO4  
High Back with Headrest  
Black Height Adjustable  
Arms/PU Pads  
£1,277



TO5  
High Back  
£1,084



TO6  
High Back with Black Fixed  
Arms/PU Pads  
£1,154



TO7  
High Back with Fixed Polished  
Aluminium Arms/PU Pads  
£1,277



TO8  
High Back with Black Height  
Adjustable Arms/PU Pads  
£1,204



TO10  
Medium Back  
£1,051



TO11  
Medium Back with  
Black Fixed Arms/PU Pads  
£1,122



TO12  
Medium Back with Fixed  
Polished Aluminium  
Arms/PU Pads  
£1,244



TO13  
Medium Back with Black Height  
Adjustable Arms/PU Pads  
£1,175



TO14  
Visitor Medium Back  
£887

5 Year  
Guarantee

## TAKE OFF EXECUTIVE TASK & VISITOR



Task & Visitor  
Seating

Shown in cream and black leather - other colours available

# TAKE OFF TASK & VISITOR

5 Year  
Guarantee

More than just style, Take Off is an innovative seating solution that can adapt to the user's body with easy to reach adjustments.

- High quality materials, mechanism and functionality provide increased comfort and productivity.
- Gas lift height adjustment
- Synchronized side tension mechanism complete with seat slide comes as standard.
- Ratchet back height adjustment.

## Product Features



## Additional Information

Visitor Chair frames in Silver only.

## Optional Extras

X	Polished Aluminium Five Star Base	£63
---	-----------------------------------	-----





# TAKE OFF TASK & VISITOR



**TO20**  
High Back

Band 1 .....	£784
Band 2 .....	£796
Band 3 .....	£827
Band 4 .....	£852
Band 5 .....	£876
Band 6 .....	£901
Band 7 .....	£927
Leather Group 1 .....	£1,084



**TO21**  
High Back with Black Fixed  
Arms/PU Pads

Band 1 .....	£854
Band 2 .....	£866
Band 3 .....	£896
Band 4 .....	£922
Band 5 .....	£946
Band 6 .....	£972
Band 7 .....	£996
Leather Group 1 .....	£1,154



**TO23**  
High Back with Black Height  
Adjustable Arms/PU Pads

Band 1 .....	£905
Band 2 .....	£921
Band 3 .....	£947
Band 4 .....	£975
Band 5 .....	£997
Band 6 .....	£1,024
Band 7 .....	£1,050
Leather Group 1 .....	£1,204



**TO24**  
Medium Back

Band 1 .....	£713
Band 2 .....	£727
Band 3 .....	£756
Band 4 .....	£784
Band 5 .....	£805
Band 6 .....	£832
Band 7 .....	£859
Leather Group 1 .....	£1,051



**TO25**  
Medium Back with Black Fixed  
Arms/PU Pads

Band 1 .....	£784
Band 2 .....	£796
Band 3 .....	£827
Band 4 .....	£852
Band 5 .....	£876
Band 6 .....	£901
Band 7 .....	£927
Leather Group 1 .....	£1,122



**TO27**  
Medium Back with Black Height  
Adjustable Arms/PU Pads

Band 1 .....	£834
Band 2 .....	£852
Band 3 .....	£878
Band 4 .....	£905
Band 5 .....	£931
Band 6 .....	£956
Band 7 .....	£979
Leather Group 1 .....	£1,175



**TO28**  
Visitor Medium Back Cantilever  
Armchair

Band 1 .....	£625
Band 2 .....	£638
Band 3 .....	£668
Band 4 .....	£694
Band 5 .....	£721
Band 6 .....	£745
Band 7 .....	£768
Leather Group 1 .....	£887

# G SERIES FABRIC TASK & VISITOR



G Series Fabric is an outstanding task chair with a number of unique features.

- Combination of superb aesthetics and functionality.
- Provides comfort and support.
- Easy to use side-tension mechanism with seat slide comes as standard.
- Picture frame outer back with one-touch ratchet height adjustment.

### Product Features



### Additional Information

Visitor Chair frames in Silver - (Chrome Frame £86 surcharge).

### Optional Extras

X	Polished Aluminium Five Star Base	£63
A23	Black Fixed Arms	£77
A24	Height Adjustable Arms	£111
A25	4D Multi Function Arms	£147



**GSR/7**  
High Back with Headrest

Band 1	£768
Band 2	£784
Band 3	£799
Band 4	£819
Band 5	£834
Band 6	£856
Band 7	£872
Leather Group 1	£1,060



**GS/7**  
High Back

Band 1	£688
Band 2	£697
Band 3	£719
Band 4	£732
Band 5	£752
Band 6	£768
Band 7	£787
Leather Group 1	£976



**GSC**  
Visitor Medium Back Cantilever

Band 1	£658
Band 2	£676
Band 3	£718
Band 4	£750
Band 5	£782
Band 6	£814
Band 7	£845
Leather Group 1	£1,037



**GSCA**  
Visitor Medium Back  
Cantilever Armchair

Band 1	£666
Band 2	£688
Band 3	£723
Band 4	£756
Band 5	£788
Band 6	£825
Band 7	£856
Leather Group 1	£1,043

Task & Visitor  
Seating



Vescom Lani 7060.49 (Band 6)

# G SERIES MESH TASK & VISITOR

The G Series Mesh provides not only an enhanced ergonomic sit but unique aesthetic appeal.

- Easy to use side-tension mechanism with seat slide.
- One-touch ratchet height adjustment.
- Extra versatility and breathability (Black Mesh).
- Matching visitor chairs on either a four leg or cantilever base.
- Perfect for executive offices and meeting areas.

## Product Features



## Additional Information

Visitor Chair frames in Silver - (Chrome Frame £69 surcharge).

## Optional Extras

X	Polished Aluminium Five Star Base	£63
A23	Black Fixed Arms	£77
A24	Height Adjustable Arms	£111
A25	4D Multi Function Arms	£147



**GSMR/7**  
High Back with Headrest

Band 1	£768
Band 2	£784
Band 3	£799
Band 4	£819
Band 5	£834
Band 6	£856
Band 7	£872
Leather Group 1	£966



**GSM/7**  
High Back

Band 1	£688
Band 2	£697
Band 3	£719
Band 4	£732
Band 5	£752
Band 6	£768
Band 7	£787
Leather Group 1	£879



**GSMC**  
Visitor Medium Back Cantilever

Band 1	£658
Band 2	£676
Band 3	£718
Band 4	£750
Band 5	£782
Band 6	£814
Band 7	£845
Leather Group 1	£940



**GSMCA**  
Visitor Medium Back Cantilever  
Armchair

Band 1	£666
Band 2	£688
Band 3	£723
Band 4	£756
Band 5	£788
Band 6	£825
Band 7	£856
Leather Group 1	£951



Vescom Lani 7060.34 (Band 6)

# MOVE UP TASK & VISITOR

5 Year  
Guarantee

This intuitive chair has the simplest of adjustments.

- Unique synchronized mechanism with seat depth adjustment as standard.
- One touch back height adjustment allows the user to achieve the optimal seated position.
- Choice of a fabric or mesh back is complemented by a selection of fixed or adjustable arms.

## Product Features



## Additional Information

A25 Arm (height and width adjustable / sliding and rotating arm pad).  
Visitor Chair frames in Silver / Black / Grey / White  
(Chrome Frame £30 surcharge).

## Optional Extras

X	Polished Aluminium Five Star Base	£63
---	-----------------------------------	-----





# MOVE UP TASK & VISITOR

5 Year  
Guarantee



**MU/7**  
Fully Upholstered

Band 1 .....	£527
Band 2 .....	£539
Band 3 .....	£557
Band 4 .....	£575
Band 5 .....	£593
Band 6 .....	£609
Band 7 .....	£627
Leather Group 1 .....	£810



**MU/7A23**  
Fully Upholstered  
Black Fixed Arms

Band 1 .....	£602
Band 2 .....	£612
Band 3 .....	£633
Band 4 .....	£652
Band 5 .....	£667
Band 6 .....	£688
Band 7 .....	£703
Leather Group 1 .....	£887



**MU/7A24**  
Fully Upholstered  
Height Adjustable Arms

Band 1 .....	£636
Band 2 .....	£648
Band 3 .....	£667
Band 4 .....	£688
Band 5 .....	£703
Band 6 .....	£722
Band 7 .....	£738
Leather Group 1 .....	£922



**MU/7A25**  
Fully Upholstered  
4D Multi-function Arms

Band 1 .....	£671
Band 2 .....	£688
Band 3 .....	£704
Band 4 .....	£723
Band 5 .....	£739
Band 6 .....	£760
Band 7 .....	£772
Leather Group 1 .....	£959



**MUM/7**  
Mesh Back

Band 1 .....	£527
Band 2 .....	£539
Band 3 .....	£557
Band 4 .....	£575
Band 5 .....	£593
Band 6 .....	£609
Band 7 .....	£627
Leather Group 1 .....	£810



**MUM/7A23**  
Mesh Back  
Black Fixed Arms

Band 1 .....	£602
Band 2 .....	£612
Band 3 .....	£633
Band 4 .....	£652
Band 5 .....	£667
Band 6 .....	£688
Band 7 .....	£703
Leather Group 1 .....	£887



**MUM/7A24**  
Mesh Back  
Height Adjustable Arms

Band 1 .....	£636
Band 2 .....	£648
Band 3 .....	£667
Band 4 .....	£688
Band 5 .....	£703
Band 6 .....	£722
Band 7 .....	£738
Leather Group 1 .....	£922



**MUM/7A25**  
Mesh Back  
4D Multi-function Arms

Band 1 .....	£671
Band 2 .....	£688
Band 3 .....	£704
Band 4 .....	£723
Band 5 .....	£739
Band 6 .....	£760
Band 7 .....	£772
Leather Group 1 .....	£959

Task & Visitor  
Seating



**MUC**  
Visitor  
Cantilever

Band 1 .....	£481
Band 2 .....	£490
Band 3 .....	£508
Band 4 .....	£528
Band 5 .....	£543
Band 6 .....	£561
Band 7 .....	£578
Leather Group 1 .....	£831



**MUMC**  
Visitor  
Mesh Back Cantilever

Band 1 .....	£481
Band 2 .....	£490
Band 3 .....	£508
Band 4 .....	£528
Band 5 .....	£543
Band 6 .....	£561
Band 7 .....	£578
Leather Group 1 .....	£831

# PLATINUM PLUS ROUND

## TASK & VISITOR

5 Year Guarantee

Platinum Plus Round provides the same unique ergonomic properties as the acclaimed original.

- Stylish pyramid base.
- Synchronized seat and back mechanism option (/2).
- Independent seat and back mechanism option (/3).
- Side tension mechanism with seat slide option (/7) - Surcharge.
- Fixed seat mechanism option (/8).
- Extreme comfort and durability.
- Ratchet back height adjustment.
- Reflex Foam Seat Structure.

Prices listed are for our most popular mechanism 3 (independent seat and back), also available /2 (synchronized) and /8 (fixed seat) at the same price. The latest synchronized side tension mechanism /7 is also available.

### Product Features



### Additional Information

Draughting versions - Fixed seat mechanism option (/8) only.  
Visitor Chair frames in Silver / Black / White / Grey -  
(Chrome Frame £35 surcharge)

### Optional Extras

/7	Synchronized side tension mechanism with seat slide - Replace /3 with /7	£54
Y	Sliding seat depth adjustment	£59
L	Inflatable lumbar support	£59
X	Polished aluminium five star base	£60



# PLATINUM PLUS ROUND TASK & VISITOR



**PPRBH/3**  
High Back

Band 1 .....	£460
Band 2 .....	£469
Band 3 .....	£486
Band 4 .....	£505
Band 5 .....	£520
Band 6 .....	£537
Band 7 .....	£553
Leather Group 1.....	£731



**PPRBH/3A2**  
High Back  
Black Fixed Arms

Band 1 .....	£516
Band 2 .....	£526
Band 3 .....	£544
Band 4 .....	£560
Band 5 .....	£577
Band 6 .....	£594
Band 7 .....	£610
Leather Group 1.....	£789



**PPRBH/3A8**  
High Back  
Black Height Adjustable  
Arms

Band 1 .....	£545
Band 2 .....	£554
Band 3 .....	£575
Band 4 .....	£591
Band 5 .....	£608
Band 6 .....	£627
Band 7 .....	£640
Leather Group 1.....	£819



**PPRBH/3A13**  
High Back  
Height Adjustable  
Foldable Arms

Band 1 .....	£564
Band 2 .....	£575
Band 3 .....	£591
Band 4 .....	£609
Band 5 .....	£627
Band 6 .....	£641
Band 7 .....	£660
Leather Group 1.....	£836



**PPRBH/3A4D**  
High Back  
4D Multi-function Arms

Band 1 .....	£606
Band 2 .....	£615
Band 3 .....	£635
Band 4 .....	£649
Band 5 .....	£667
Band 6 .....	£688
Band 7 .....	£699
Leather Group 1.....	£877

**PPRBR/3**

As above with Headrest

Band 1 .....	£553
Band 2 .....	£575
Band 3 .....	£609
Band 4 .....	£640
Band 5 .....	£673
Band 6 .....	£703
Band 7 .....	£734
Leather Group 1.....	£930

**PPRBR/3A2**

As above with Headrest

Band 1 .....	£609
Band 2 .....	£630
Band 3 .....	£664
Band 4 .....	£696
Band 5 .....	£728
Band 6 .....	£760
Band 7 .....	£791
Leather Group 1.....	£983

**PPRBR/3A8**

As above with Headrest

Band 1 .....	£640
Band 2 .....	£661
Band 3 .....	£696
Band 4 .....	£729
Band 5 .....	£760
Band 6 .....	£792
Band 7 .....	£823
Leather Group 1.....	£1,020

**PPRBR/3A13**

As above with Headrest

Band 1 .....	£660
Band 2 .....	£677
Band 3 .....	£716
Band 4 .....	£748
Band 5 .....	£776
Band 6 .....	£809
Band 7 .....	£839
Leather Group 1.....	£1,035

**PPRBR/3A4D**

As above with Headrest

Band 1 .....	£699
Band 2 .....	£721
Band 3 .....	£755
Band 4 .....	£790
Band 5 .....	£820
Band 6 .....	£853
Band 7 .....	£882
Leather Group 1.....	£1,079



**PPRBM/3**  
Medium Back

Band 1 .....	£434
Band 2 .....	£446
Band 3 .....	£465
Band 4 .....	£482
Band 5 .....	£498
Band 6 .....	£517
Band 7 .....	£533
Leather Group 1.....	£707



**PPRBM/3A2**  
Medium Back  
Black Fixed Arms

Band 1 .....	£490
Band 2 .....	£503
Band 3 .....	£519
Band 4 .....	£536
Band 5 .....	£552
Band 6 .....	£572
Band 7 .....	£586
Leather Group 1.....	£762



**PPRBM/3A8**  
Medium Back  
Black Height Adjustable  
Arms

Band 1 .....	£523
Band 2 .....	£535
Band 3 .....	£552
Band 4 .....	£572
Band 5 .....	£586
Band 6 .....	£606
Band 7 .....	£620
Leather Group 1.....	£796



**PPRBM/3A13**  
Medium Back  
Height Adjustable  
Foldable Arms

Band 1 .....	£539
Band 2 .....	£552
Band 3 .....	£572
Band 4 .....	£587
Band 5 .....	£606
Band 6 .....	£624
Band 7 .....	£638
Leather Group 1.....	£815



**PPRBM/3A4D**  
Medium Back  
4D Multi-function Arms

Band 1 .....	£583
Band 2 .....	£594
Band 3 .....	£611
Band 4 .....	£631
Band 5 .....	£645
Band 6 .....	£664
Band 7 .....	£679
Leather Group 1.....	£856

**U**  
Upholstered  
Back Panel

Band 1 .....	£40
Band 2 .....	£54
Band 3 .....	£67
Band 4 .....	£88
Band 5 .....	£103
Band 6 .....	£120
Band 7 .....	£139
Leather Group 1.....	£217



**PPRBHXC**  
Visitor High Back  
Cantilever

Band 1 .....	£404
Band 2 .....	£415
Band 3 .....	£432
Band 4 .....	£449
Band 5 .....	£467
Band 6 .....	£483
Band 7 .....	£500
Leather Group 1.....	£675



**PPRBMXC**  
Visitor Medium Back  
Cantilever

Band 1 .....	£384
Band 2 .....	£393
Band 3 .....	£411
Band 4 .....	£428
Band 5 .....	£445
Band 6 .....	£464
Band 7 .....	£477
Leather Group 1.....	£656



**PPRMD/8**  
Medium Back  
Draughting Chair  
(Glides)

Band 1 .....	£500
Band 2 .....	£510
Band 3 .....	£530
Band 4 .....	£546
Band 5 .....	£564
Band 6 .....	£580
Band 7 .....	£595
Leather Group 1.....	£770



**PPRMD/8A2**  
Medium Back  
Draughting Chair  
Black Fixed Arms  
(Glides)

Band 1 .....	£555
Band 2 .....	£571
Band 3 .....	£586
Band 4 .....	£606
Band 5 .....	£620
Band 6 .....	£638
Band 7 .....	£656
Leather Group 1.....	£829

# PLATINUM PLUS SQUARED

## TASK & VISITOR



Platinum Plus Squared provides the same unique ergonomic properties as the acclaimed original.

- Stylish pyramid base.
- Synchronized seat and back mechanism option (/2).
- Independent seat and back mechanism option (/3).
- Side tension mechanism with seat slide option (/7) - Surcharge.
- Fixed seat mechanism option (/8).
- Extreme comfort and durability.
- Reflex Foam Seat Structure.
- Ratchet back height adjustment.

Prices listed are for our most popular mechanism 3 (independent seat and back), also available /2 (synchronized) and /8 (fixed seat) at the same price. The latest synchronized side tension mechanism /7 is also available.

### Product Features



### Additional Information

Draughting versions - Fixed seat mechanism option (/8) only.  
 Visitor Chair frames in Silver / Black / White / Grey -  
 (Chrome Frame £35 surcharge)

### Optional Extras

/7	Synchronized side tension mechanism with seat slide - Replace /3 with /7	£54
Y	Sliding seat depth adjustment	£59
L	Inflatable lumbar support	£59
X	Polished aluminium five star base	£60



Task & Visitor Seating

5 Year Guarantee

# PLATINUM PLUS SQUARED TASK & VISITOR



**PPSH/3**  
High Back

Band 1 .....	£460
Band 2 .....	£469
Band 3 .....	£486
Band 4 .....	£505
Band 5 .....	£520
Band 6 .....	£537
Band 7 .....	£553
Leather Group 1.....	£731



**PPSH/3A2**  
High Back  
Black Fixed Arms

Band 1 .....	£516
Band 2 .....	£526
Band 3 .....	£544
Band 4 .....	£560
Band 5 .....	£577
Band 6 .....	£594
Band 7 .....	£610
Leather Group 1.....	£789



**PPSH/3A8**  
High Back  
Black Height Adjustable  
Arms

Band 1 .....	£545
Band 2 .....	£554
Band 3 .....	£575
Band 4 .....	£591
Band 5 .....	£608
Band 6 .....	£627
Band 7 .....	£640
Leather Group 1.....	£819



**PPSH/3A13**  
High Back  
Height Adjustable  
Foldable Arms

Band 1 .....	£564
Band 2 .....	£575
Band 3 .....	£591
Band 4 .....	£609
Band 5 .....	£627
Band 6 .....	£641
Band 7 .....	£660
Leather Group 1.....	£836



**PPSH/3A4D**  
High Back  
4D Arms Multi-function  
Arms

Band 1 .....	£606
Band 2 .....	£615
Band 3 .....	£635
Band 4 .....	£649
Band 5 .....	£667
Band 6 .....	£688
Band 7 .....	£699
Leather Group 1.....	£877

**PPSR/3**  
As above with Headrest

Band 1 .....	£553
Band 2 .....	£575
Band 3 .....	£609
Band 4 .....	£640
Band 5 .....	£673
Band 6 .....	£703
Band 7 .....	£734
Leather Group 1.....	£930

**PPSR/3A2**  
As above with Headrest

Band 1 .....	£609
Band 2 .....	£630
Band 3 .....	£664
Band 4 .....	£696
Band 5 .....	£728
Band 6 .....	£760
Band 7 .....	£791
Leather Group 1.....	£983

**PPSR/3A8**  
As above with Headrest

Band 1 .....	£640
Band 2 .....	£661
Band 3 .....	£696
Band 4 .....	£729
Band 5 .....	£760
Band 6 .....	£792
Band 7 .....	£823
Leather Group 1.....	£1,020

**PPSR/3A13**  
As above with Headrest

Band 1 .....	£660
Band 2 .....	£677
Band 3 .....	£716
Band 4 .....	£748
Band 5 .....	£776
Band 6 .....	£809
Band 7 .....	£839
Leather Group 1.....	£1,035

**PPSR/3A4D**  
As above with Headrest

Band 1 .....	£699
Band 2 .....	£721
Band 3 .....	£755
Band 4 .....	£790
Band 5 .....	£832
Band 6 .....	£853
Band 7 .....	£882
Leather Group 1.....	£1,079



**PPSM/3**  
Medium Back

Band 1 .....	£434
Band 2 .....	£446
Band 3 .....	£465
Band 4 .....	£482
Band 5 .....	£498
Band 6 .....	£517
Band 7 .....	£533
Leather Group 1.....	£707



**PPSM/3A2**  
Medium Back  
Black Fixed Arms

Band 1 .....	£490
Band 2 .....	£503
Band 3 .....	£519
Band 4 .....	£536
Band 5 .....	£552
Band 6 .....	£572
Band 7 .....	£586
Leather Group 1.....	£762



**PPSM/3A8**  
Medium Back  
Black Height Adjustable  
Arms

Band 1 .....	£523
Band 2 .....	£535
Band 3 .....	£552
Band 4 .....	£572
Band 5 .....	£586
Band 6 .....	£606
Band 7 .....	£620
Leather Group 1.....	£796



**PPSM/3A13**  
Medium Back  
Height Adjustable  
Foldable Arms

Band 1 .....	£539
Band 2 .....	£552
Band 3 .....	£572
Band 4 .....	£587
Band 5 .....	£606
Band 6 .....	£624
Band 7 .....	£638
Leather Group 1.....	£815



**PPSM/3A4D**  
Medium Back  
4D Arms Multi-function  
Arms

Band 1 .....	£583
Band 2 .....	£594
Band 3 .....	£611
Band 4 .....	£631
Band 5 .....	£645
Band 6 .....	£664
Band 7 .....	£679
Leather Group 1.....	£856

**U**  
Upholstered  
Back Panel

Band 1 .....	£40
Band 2 .....	£54
Band 3 .....	£67
Band 4 .....	£88
Band 5 .....	£103
Band 6 .....	£120
Band 7 .....	£139
Leather Group 1.....	£217



**PPSHXC**  
Visitor High Back  
Cantilever

Band 1 .....	£404
Band 2 .....	£415
Band 3 .....	£432
Band 4 .....	£449
Band 5 .....	£467
Band 6 .....	£483
Band 7 .....	£500
Leather Group 1.....	£675



**PPSMXC**  
Visitor Medium Back  
Cantilever

Band 1 .....	£384
Band 2 .....	£393
Band 3 .....	£411
Band 4 .....	£428
Band 5 .....	£445
Band 6 .....	£464
Band 7 .....	£477
Leather Group 1.....	£656



**PPSMD/8**  
Medium Back  
Draughting Chair  
(Glides)

Band 1 .....	£500
Band 2 .....	£510
Band 3 .....	£530
Band 4 .....	£546
Band 5 .....	£564
Band 6 .....	£580
Band 7 .....	£595
Leather Group 1.....	£770



**PPSMD/8A2**  
Medium Back  
Draughting Chair  
Black Fixed Arms  
(Glides)

Band 1 .....	£555
Band 2 .....	£571
Band 3 .....	£586
Band 4 .....	£606
Band 5 .....	£620
Band 6 .....	£638
Band 7 .....	£656
Leather Group 1.....	£829

# PLATINUM ERGO

## TASK & VISITOR

5 Year Guarantee

Platinum Ergo has all the standard features of the classic Platinum task chair but with the added benefit of enhanced ergonomic properties.

- Independent seat and back mechanism option (/3).
- Synchronized seat and back mechanism option (/2).
- Fixed seat mechanism option (/8).
- One touch back height adjustment.
- Provides full support to upper and lower spine.
- Available in medium or high back options.
- Ratchet back height adjustment.
- Reflex Foam Seat Structure.

Prices listed are for our most popular mechanism 3 (independent seat and back), also available /2 (synchronized) and /8 (fixed seat) at the same price.

### Product Features



### Additional Information

Draughting versions - Fixed seat mechanism option (/8) only.  
Visitor Chair frames in Silver / Black / White / Grey -  
(Chrome Frame £35 surcharge)

### Optional Extras

Y	Sliding seat depth adjustment	£59
L	Inflatable lumbar support	£59
X	Polished aluminium five star base	£60





**PLH/3**  
High Back

Band 1 .....	£460
Band 2 .....	£469
Band 3 .....	£486
Band 4 .....	£505
Band 5 .....	£520
Band 6 .....	£537
Band 7 .....	£553
Leather Group 1 .....	£731



**PLH/3A2**  
High Back  
Black Fixed Arms

Band 1 .....	£516
Band 2 .....	£526
Band 3 .....	£544
Band 4 .....	£560
Band 5 .....	£577
Band 6 .....	£594
Band 7 .....	£610
Leather Group 1 .....	£789



**PLH/3A8**  
High Back Black  
Height Adjustable Arms

Band 1 .....	£545
Band 2 .....	£554
Band 3 .....	£575
Band 4 .....	£591
Band 5 .....	£608
Band 6 .....	£627
Band 7 .....	£640
Leather Group 1 .....	£819



**PLH/3A13**  
High Back  
Height Adjustable  
Foldable Arms

Band 1 .....	£564
Band 2 .....	£575
Band 3 .....	£591
Band 4 .....	£609
Band 5 .....	£627
Band 6 .....	£641
Band 7 .....	£660
Leather Group 1 .....	£836

**PLR/3**  
As Above with Headrest

Band 1 .....	£553
Band 2 .....	£575
Band 3 .....	£609
Band 4 .....	£640
Band 5 .....	£673
Band 6 .....	£703
Band 7 .....	£734
Leather Group 1 .....	£930

**PLR/3A2**  
As Above with Headrest

Band 1 .....	£609
Band 2 .....	£630
Band 3 .....	£664
Band 4 .....	£696
Band 5 .....	£728
Band 6 .....	£760
Band 7 .....	£791
Leather Group 1 .....	£983

**PLR/3A8**  
As Above with Headrest

Band 1 .....	£640
Band 2 .....	£661
Band 3 .....	£696
Band 4 .....	£729
Band 5 .....	£760
Band 6 .....	£792
Band 7 .....	£823
Leather Group 1 .....	£1,020

**PLR/3A13**  
As Above with Headrest

Band 1 .....	£660
Band 2 .....	£677
Band 3 .....	£716
Band 4 .....	£748
Band 5 .....	£776
Band 6 .....	£809
Band 7 .....	£839
Leather Group 1 .....	£1,035



**PLM/3**  
Medium Back

Band 1 .....	£434
Band 2 .....	£446
Band 3 .....	£465
Band 4 .....	£482
Band 5 .....	£498
Band 6 .....	£517
Band 7 .....	£533
Leather Group 1 .....	£707



**PLM/3A2**  
Medium Back  
Black Fixed Arms

Band 1 .....	£490
Band 2 .....	£503
Band 3 .....	£519
Band 4 .....	£536
Band 5 .....	£552
Band 6 .....	£572
Band 7 .....	£586
Leather Group 1 .....	£762



**PLM/3A8**  
Medium Back  
Black Height Adjustable Arms

Band 1 .....	£523
Band 2 .....	£535
Band 3 .....	£552
Band 4 .....	£572
Band 5 .....	£586
Band 6 .....	£606
Band 7 .....	£620
Leather Group 1 .....	£796



**PLM/3A13**  
Medium Back  
Height Adjustable  
Foldable Arms

Band 1 .....	£539
Band 2 .....	£552
Band 3 .....	£572
Band 4 .....	£587
Band 5 .....	£606
Band 6 .....	£624
Band 7 .....	£638
Leather Group 1 .....	£815



**PLHXC**  
Visitor High Back Cantilever

Band 1 .....	£404
Band 2 .....	£415
Band 3 .....	£432
Band 4 .....	£449
Band 5 .....	£467
Band 6 .....	£483
Band 7 .....	£500
Leather Group 1 .....	£675



**PLMD/8**  
Medium Back Draughting Chair  
(Glides)

Band 1 .....	£500
Band 2 .....	£510
Band 3 .....	£530
Band 4 .....	£546
Band 5 .....	£564
Band 6 .....	£580
Band 7 .....	£595
Leather Group 1 .....	£770



**PLMD/8A2**  
Medium Back Draughting Chair  
Black Fixed Arms (Glides)

Band 1 .....	£555
Band 2 .....	£571
Band 3 .....	£586
Band 4 .....	£606
Band 5 .....	£620
Band 6 .....	£638
Band 7 .....	£656
Leather Group 1 .....	£829

# PLATINUM SQUARED TASK & VISITOR



Platinum Squared offers all the features and ergonomic benefits of the Platinum Ergo, whilst providing an alternative stylish back design.

- Independent seat and back mechanism option (/3).
- Synchronized seat and back mechanism option (/2).
- Fixed seat mechanism option (/8).
- One touch back height adjustment.
- Available in medium or high back options.
- Ratchet back height adjustment.
- Reflex Foam Seat Structure.

Prices listed are for our most popular mechanism 3 (independent seat and back), also available /2 (synchronized) and /8 (fixed seat) at the same price.

## Product Features



## Additional Information

Draughting versions - Fixed seat mechanism option (/8) only.  
Visitor Chair frames in Silver / Black / White / Grey -  
(Chrome Frame £29 surcharge)

## Optional Extras

Y	Sliding seat depth adjustment	£59
L	Inflatable lumbar support	£59
X	Polished aluminium five star base	£60





5 Year  
Guarantee

# PLATINUM SQUARED TASK & VISITOR



**PSQH/3**  
High Back

Band 1 .....	£460
Band 2 .....	£469
Band 3 .....	£486
Band 4 .....	£505
Band 5 .....	£520
Band 6 .....	£537
Band 7 .....	£553
Leather Group 1 .....	£731

**PSQR/3**  
As Above with Headrest

Band 1 .....	£553
Band 2 .....	£575
Band 3 .....	£609
Band 4 .....	£640
Band 5 .....	£673
Band 6 .....	£703
Band 7 .....	£734
Leather Group 1 .....	£930



**PSQM/3**  
Medium Back

Band 1 .....	£434
Band 2 .....	£446
Band 3 .....	£465
Band 4 .....	£482
Band 5 .....	£498
Band 6 .....	£517
Band 7 .....	£533
Leather Group 1 .....	£707



**PSQHXC**  
Visitor High Back Cantilever

Band 1 .....	£404
Band 2 .....	£415
Band 3 .....	£432
Band 4 .....	£449
Band 5 .....	£467
Band 6 .....	£483
Band 7 .....	£500
Leather Group 1 .....	£675



**PSQH/3A2**  
High Back  
Black Fixed Arms

Band 1 .....	£516
Band 2 .....	£526
Band 3 .....	£544
Band 4 .....	£560
Band 5 .....	£577
Band 6 .....	£594
Band 7 .....	£610
Leather Group 1 .....	£789

**PSQR/3A2**  
As Above with Headrest

Band 1 .....	£609
Band 2 .....	£630
Band 3 .....	£664
Band 4 .....	£696
Band 5 .....	£728
Band 6 .....	£760
Band 7 .....	£791
Leather Group 1 .....	£983



**PSQM/3A2**  
Medium Back  
Black Fixed Arms

Band 1 .....	£490
Band 2 .....	£503
Band 3 .....	£519
Band 4 .....	£536
Band 5 .....	£552
Band 6 .....	£572
Band 7 .....	£586
Leather Group 1 .....	£762



**PSQMD/8**  
Medium Back Draughting Chair  
(Glides)

Band 1 .....	£500
Band 2 .....	£510
Band 3 .....	£530
Band 4 .....	£546
Band 5 .....	£564
Band 6 .....	£580
Band 7 .....	£595
Leather Group 1 .....	£770



**PSQH/3A8**  
High Back  
Black Height Adjustable  
Arms

Band 1 .....	£545
Band 2 .....	£554
Band 3 .....	£575
Band 4 .....	£591
Band 5 .....	£608
Band 6 .....	£627
Band 7 .....	£640
Leather Group 1 .....	£819

**PSQR/3A8**  
As Above with Headrest

Band 1 .....	£640
Band 2 .....	£661
Band 3 .....	£696
Band 4 .....	£729
Band 5 .....	£760
Band 6 .....	£792
Band 7 .....	£823
Leather Group 1 .....	£1,020



**PSQM/3A8**  
Medium Back  
Black Height Adjustable  
Arms

Band 1 .....	£523
Band 2 .....	£536
Band 3 .....	£552
Band 4 .....	£572
Band 5 .....	£586
Band 6 .....	£606
Band 7 .....	£620
Leather Group 1 .....	£796



**PSQMD/8A2**  
Medium Back Draughting Chair  
Fixed Black Arms (Glides)

Band 1 .....	£555
Band 2 .....	£571
Band 3 .....	£586
Band 4 .....	£606
Band 5 .....	£620
Band 6 .....	£638
Band 7 .....	£656
Leather Group 1 .....	£829



**PSQH/3A13**  
High Back  
Height Adjustable  
Foldable Arms

Band 1 .....	£564
Band 2 .....	£575
Band 3 .....	£591
Band 4 .....	£609
Band 5 .....	£627
Band 6 .....	£641
Band 7 .....	£660
Leather Group 1 .....	£836

**PSQR/3A13**  
As Above with Headrest

Band 1 .....	£660
Band 2 .....	£677
Band 3 .....	£716
Band 4 .....	£748
Band 5 .....	£776
Band 6 .....	£809
Band 7 .....	£839
Leather Group 1 .....	£1,035



**PSQM/3A13**  
Medium Back  
Height Adjustable  
Foldable Arms

Band 1 .....	£539
Band 2 .....	£552
Band 3 .....	£572
Band 4 .....	£587
Band 5 .....	£606
Band 6 .....	£624
Band 7 .....	£638
Leather Group 1 .....	£815

Task & Visitor  
Seating

# PLATINUM MESH

## TASK & VISITOR

5 Year Guarantee

Platinum Mesh offers all of the features and ergonomic benefits of the Platinum Ergo whilst providing a modern mesh back.

- Independent seat and back mechanism option (/3)
- One touch back height adjustment
- Integral lumbar support with adjustable angle
- Reflex Foam seat structure
- Optional adjustable Headrest

### Product Features



### Additional Information

A4D Arm (height and width adjustable / sliding and rotating arm pad).



### Optional Extras

Y	Sliding seat depth adjustment	£59
X	Polished Aluminium Five Star Base	£60
R	Headrest	£100



PMH/3 Mesh Back	PMH/3A1 Mesh Back Fixed Arms	PMH/3A8 Mesh Back Height Adjustable Arms	PMH/3A13 Mesh Back Height Adjustable Foldable Arms	PMH/3A4D Mesh Back 4D Multi-functional Arms
Band 1 ..... £445	Band 1 ..... £500	Band 1 ..... £532	Band 1 ..... £551	Band 1 ..... £587
Band 2 ..... £456	Band 2 ..... £510	Band 2 ..... £545	Band 2 ..... £561	Band 2 ..... £598
Band 3 ..... £474	Band 3 ..... £530	Band 3 ..... £561	Band 3 ..... £578	Band 3 ..... £615
Band 4 ..... £492	Band 4 ..... £549	Band 4 ..... £578	Band 4 ..... £596	Band 4 ..... £635
Band 5 ..... £506	Band 5 ..... £563	Band 5 ..... £594	Band 5 ..... £611	Band 5 ..... £649
Band 6 ..... £526	Band 6 ..... £580	Band 6 ..... £611	Band 6 ..... £632	Band 6 ..... £668
Band 7 ..... £544	Band 7 ..... £596	Band 7 ..... £629	Band 7 ..... £645	Band 7 ..... £683
Leather Group 1 ..... £620	Leather Group 1 ..... £674	Leather Group 1 ..... £707	Leather Group 1 ..... £725	Leather Group 1 ..... £763



Camira Blazer Sheffield CUZ1T (Band 4)

5 Year Guarantee

# HARLEQUIN MESH TASK & VISITOR

- Ratchet back height adjustment.
- Synchronised side tension mechanism complete with seat slide adjustment.
- Gas lift height adjustment.

## Product Features



## Additional Information

We recommend that you request fabric samples prior to ordering.

## Optional Extras

X Polished aluminium five star base £63



HQHM  
Mesh Back

Band 1 .....	£473
Band 2 .....	£486
Band 3 .....	£504
Band 4 .....	£522
Band 5 .....	£540
Band 6 .....	£558
Band 7 .....	£575
Leather Group 1.....	£658



HQHM/8  
Mesh Back and A8 Height  
Adjustable Arms

Band 1 .....	£560
Band 2 .....	£574
Band 3 .....	£593
Band 4 .....	£609
Band 5 .....	£627
Band 6 .....	£644
Band 7 .....	£664
Leather Group 1.....	£745



HQHM/A13  
Mesh Back and A13 Height  
Adjustable  
Foldable Arms

Band 1 .....	£598
Band 2 .....	£608
Band 3 .....	£627
Band 4 .....	£644
Band 5 .....	£664
Band 6 .....	£678
Band 7 .....	£697
Leather Group 1.....	£782



Gabriel Repetto 01101 (Band 2)

# SANTIS ERGO TASK & VISITOR



Santis Ergo is an exquisitely proportioned chair with superb posture design and engineering quality.

- Offers optimum back support.
- Suited to intense working environments, which demand prolonged periods of sitting.
- Soft touch mesh.
- Adjustable lumbar pad.
- Synchronized side tension mechanism with seat slide and gas lift height adjustment.
- Reflex Foam Seat Structure.

### Product Features



### Additional Information

A4D Arm (height and width adjustable / sliding and rotating arm pad).

### Optional Extras



X	Polished Aluminium Five Star Base	£62
R	Headrest	£103



SIE/7 Mesh Back	SIE/7A1 Mesh Back Black Fixed Arms	SIE/7A8 Mesh Back Black Height Adjustable Arms	SIE/7A13 Mesh Back Height Adjustable Foldable Arms	SIE/7A4D Mesh Back 4D Multi-function Arms
Band 1 ..... £482	Band 1 ..... £538	Band 1 ..... £570	Band 1 ..... £591	Band 1 ..... £627
Band 2 ..... £491	Band 2 ..... £550	Band 2 ..... £584	Band 2 ..... £600	Band 2 ..... £639
Band 3 ..... £511	Band 3 ..... £568	Band 3 ..... £600	Band 3 ..... £621	Band 3 ..... £657
Band 4 ..... £531	Band 4 ..... £588	Band 4 ..... £621	Band 4 ..... £637	Band 4 ..... £678
Band 5 ..... £547	Band 5 ..... £602	Band 5 ..... £634	Band 5 ..... £655	Band 5 ..... £693
Band 6 ..... £565	Band 6 ..... £623	Band 6 ..... £655	Band 6 ..... £675	Band 6 ..... £712
Band 7 ..... £583	Band 7 ..... £637	Band 7 ..... £668	Band 7 ..... £688	Band 7 ..... £727
Leather Group 1 ..... £660	Leather Group 1 ..... £718	Leather Group 1 ..... £753	Leather Group 1 ..... £772	Leather Group 1 ..... £810



Camira Blazer Barnard CUZ2S (Band 4)

Santis Squared is an exquisitely proportioned chair with superb posture design and engineering quality.

- Offers optimum back support.
- Suited to intense working environments, which demand prolonged periods of sitting.
- Soft touch mesh.
- Adjustable lumbar pad.
- Synchronized side tension mechanism with seat slide and gas lift height adjustment.
- Reflex Foam Seat Structure.

Product Features



Additional Information

A4D Arm (height and width adjustable / sliding and rotating arm pad).

Optional Extras



X	Polished Aluminium Five Star Base	£62
R	Headrest	£103



SIS/7 Mesh Back	SIS/7A1 Mesh Back Black Fixed Arms	SIS/7A8 Mesh Back Black Height Adjustable Arms	SIS/7A13 Mesh Back Height Adjustable Foldable Arms	SIS/7A4D Mesh Back 4D Multi-function Arms
Band 1 ..... £482	Band 1 ..... £538	Band 1 ..... £570	Band 1 ..... £591	Band 1 ..... £627
Band 2 ..... £491	Band 2 ..... £550	Band 2 ..... £584	Band 2 ..... £600	Band 2 ..... £639
Band 3 ..... £511	Band 3 ..... £568	Band 3 ..... £600	Band 3 ..... £621	Band 3 ..... £657
Band 4 ..... £530	Band 4 ..... £586	Band 4 ..... £621	Band 4 ..... £637	Band 4 ..... £678
Band 5 ..... £547	Band 5 ..... £602	Band 5 ..... £634	Band 5 ..... £655	Band 5 ..... £693
Band 6 ..... £565	Band 6 ..... £623	Band 6 ..... £655	Band 6 ..... £675	Band 6 ..... £712
Band 7 ..... £583	Band 7 ..... £637	Band 7 ..... £668	Band 7 ..... £688	Band 7 ..... £727
Leather Group 1 ..... £660	Leather Group 1 ..... £718	Leather Group 1 ..... £753	Leather Group 1 ..... £772	Leather Group 1 ..... £810



Gabriel Crisp 04601 (Band 4)

Task & Visitor  
Seating

# ADLINGTON TASK & VISITOR

5 Year  
Guarantee

As a very competitively priced product the Adlington range offers exceptional value in terms of quality and posture design.

- Designed for ease of use.
- Incorporates seat height adjustment.
- Fixed seat /adjustable back mechanism option (/4).
- Independent seat and back mechanism option (/9).
- Available with or without fixed arms.
- The ideal choice for an everyday work chair.
- Handwheel back height adjustment.

## Product Features



## Additional Information

Draughting versions - Mechanism option (/4) only.  
Visitor Chair frames in Silver / Black / White / Grey -  
(Chrome Frame £30 surcharge)

## Optional Extras

Y	Sliding seat depth adjustment	£62
L	Inflatable lumbar support	£62
X	Polished aluminium five star base	£63



5 Year  
Guarantee



**AO/4**  
High Back  
Mechanism 4

Band 1 .....	£262
Band 2 .....	£274
Band 3 .....	£292
Band 4 .....	£314
Band 5 .....	£328
Band 6 .....	£346
Band 7 .....	£365
Leather Group 1 .....	£554



**AO/4A2**  
High Back  
Black Fixed Arms  
Mechanism 4

Band 1 .....	£320
Band 2 .....	£332
Band 3 .....	£348
Band 4 .....	£371
Band 5 .....	£386
Band 6 .....	£404
Band 7 .....	£422
Leather Group 1 .....	£610



**AO/4A8**  
High Back  
Black Height Adjustable Arms  
Mechanism 4

Band 1 .....	£352
Band 2 .....	£368
Band 3 .....	£384
Band 4 .....	£403
Band 5 .....	£419
Band 6 .....	£440
Band 7 .....	£454
Leather Group 1 .....	£643



**AO/4A13**  
High Back  
A13 Height Adjustable Foldable  
Arms Mechanism 4

Band 1 .....	£377
Band 2 .....	£387
Band 3 .....	£405
Band 4 .....	£425
Band 5 .....	£442
Band 6 .....	£458
Band 7 .....	£477
Leather Group 1 .....	£666



**AO/9**  
High Back  
Mechanism 9

Band 1 .....	£282
Band 2 .....	£293
Band 3 .....	£315
Band 4 .....	£332
Band 5 .....	£347
Band 6 .....	£369
Band 7 .....	£384
Leather Group 1 .....	£574



**AO/9A2**  
High Back  
Black Fixed Arms  
Mechanism 9

Band 1 .....	£341
Band 2 .....	£350
Band 3 .....	£372
Band 4 .....	£388
Band 5 .....	£405
Band 6 .....	£425
Band 7 .....	£442
Leather Group 1 .....	£632



**AO/9A8**  
High Back  
Black Height Adjustable Arms  
Mechanism 9

Band 1 .....	£377
Band 2 .....	£387
Band 3 .....	£405
Band 4 .....	£425
Band 5 .....	£442
Band 6 .....	£458
Band 7 .....	£477
Leather Group 1 .....	£666



**AO/9A13**  
High Back  
A13 Height Adjustable Foldable  
Arms Mechanism 9

Band 1 .....	£393
Band 2 .....	£405
Band 3 .....	£425
Band 4 .....	£443
Band 5 .....	£458
Band 6 .....	£481
Band 7 .....	£495
Leather Group 1 .....	£686



**AOC**  
Visitor High Back Cantilever

Band 1 .....	£261
Band 2 .....	£273
Band 3 .....	£291
Band 4 .....	£312
Band 5 .....	£326
Band 6 .....	£345
Band 7 .....	£365
Leather Group 1 .....	£554



**AOC/A2**  
Visitor High Back Cantilever  
Black Fixed Arms

Band 1 .....	£319
Band 2 .....	£330
Band 3 .....	£347
Band 4 .....	£369
Band 5 .....	£384
Band 6 .....	£403
Band 7 .....	£419
Leather Group 1 .....	£608



**AOD/4**  
Draughting Chair (Glides)

Band 1 .....	£368
Band 2 .....	£378
Band 3 .....	£394
Band 4 .....	£413
Band 5 .....	£432
Band 6 .....	£448
Band 7 .....	£466
Leather Group 1 .....	£657



**AOD/4A2**  
Draughting Chair Black Fixed  
Arms (Glides)

Band 1 .....	£422
Band 2 .....	£434
Band 3 .....	£451
Band 4 .....	£469
Band 5 .....	£488
Band 6 .....	£505
Band 7 .....	£522
Leather Group 1 .....	£710

# ADLINGTON MESH TASK & VISITOR

5 Year  
Guarantee

The compact design of the Adlington Mesh incorporates a posture design and seat comfort usually associated with higher value models.

- Hand wheel back height adjustment.
- Fixed seat /adjustable back mechanism (/4).
- Independent seat and back mechanism option (/9).
- Gas height adjustment.

## Product Features



## Additional Information

Draughting versions - Mechanism option (/4) only.

## Optional Extras

Y	Sliding seat depth adjustment	£60
X	Polished aluminium five star base	£61







**AM/4**  
High Back  
Mechanism 4

Band 1 .....	£327
Band 2 .....	£337
Band 3 .....	£356
Band 4 .....	£372
Band 5 .....	£392
Band 6 .....	£408
Band 7 .....	£425
Leather Group 1 .....	£517



**AM/4A2**  
High Back  
Black Fixed Arms  
Mechanism 4

Band 1 .....	£374
Band 2 .....	£385
Band 3 .....	£403
Band 4 .....	£423
Band 5 .....	£438
Band 6 .....	£457
Band 7 .....	£474
Leather Group 1 .....	£565



**AM/4A8**  
High Back  
Black Height Adjustable Arms  
Mechanism 4

Band 1 .....	£415
Band 2 .....	£427
Band 3 .....	£443
Band 4 .....	£462
Band 5 .....	£478
Band 6 .....	£496
Band 7 .....	£514
Leather Group 1 .....	£606



**AM/4A13**  
High Back  
Black Height Adjustable &  
Foldable Arms  
Mechanism 4

Band 1 .....	£437
Band 2 .....	£447
Band 3 .....	£465
Band 4 .....	£483
Band 5 .....	£501
Band 6 .....	£517
Band 7 .....	£537
Leather Group 1 .....	£628



**AM/9**  
High Back  
Mechanism 9

Band 1 .....	£344
Band 2 .....	£359
Band 3 .....	£374
Band 4 .....	£394
Band 5 .....	£409
Band 6 .....	£429
Band 7 .....	£443
Leather Group 1 .....	£537



**AM/9A2**  
High Back  
Black Fixed Arms  
Mechanism 9

Band 1 .....	£395
Band 2 .....	£404
Band 3 .....	£425
Band 4 .....	£442
Band 5 .....	£458
Band 6 .....	£477
Band 7 .....	£493
Leather Group 1 .....	£586



**AM/9A8**  
High Back  
Black Height Adjustable Arms  
Mechanism 9

Band 1 .....	£434
Band 2 .....	£444
Band 3 .....	£463
Band 4 .....	£482
Band 5 .....	£498
Band 6 .....	£516
Band 7 .....	£532
Leather Group 1 .....	£625



**AM/9A13**  
High Back  
Black Height Adjustable &  
Foldable Arms  
Mechanism 9

Band 1 .....	£454
Band 2 .....	£470
Band 3 .....	£484
Band 4 .....	£504
Band 5 .....	£518
Band 6 .....	£541
Band 7 .....	£555
Leather Group 1 .....	£648



**AMD/4**  
Draughting Chair  
(Glides)

Band 1 .....	£427
Band 2 .....	£437
Band 3 .....	£455
Band 4 .....	£473
Band 5 .....	£487
Band 6 .....	£506
Band 7 .....	£520
Leather Group 1 .....	£617



**AMD/4A2**  
Draughting Chair  
Black Fixed Arms  
(Glides)

Band 1 .....	£474
Band 2 .....	£484
Band 3 .....	£502
Band 4 .....	£519
Band 5 .....	£537
Band 6 .....	£555
Band 7 .....	£570
Leather Group 1 .....	£662

# BROMLEY 24/7 TASK & VISITOR



A chair that offers superb comfort and functionality.

- Ideal for heavy duty use in Police, Security, Air Traffic Control rooms and other 24 hour working environments.
- Perfect when user needs to be seated for long periods of time.
- 24/7, 365 days a year chair.
- Exceeds level 'S' certification.
- Reflex Foam Seat Structure.

### Product Features



### Additional Information

The prices highlighted below show 24/7 fabric (Band 3)



**AXR24/7**  
High Back with Headrest

Band 1 .....	£862
Band 2 .....	£878
Band 3 - 24/7 .....	£885
Band 4 .....	£891
Band 5 .....	£965
Band 6 .....	£993
Band 7 .....	£1,023
Leather Group 1 .....	POA



**AXR24/7A22**  
High Back with A22 Multi-function Push Button Arms

Band 1 .....	£987
Band 2 .....	£1,005
Band 3 - 24/7 .....	£1,008
Band 4 .....	£1,015
Band 5 .....	£1,092
Band 6 .....	£1,118
Band 7 .....	£1,146
Leather Group 1 .....	POA



**AX24/7**  
High Back

Band 1 .....	£751
Band 2 .....	£768
Band 3 - 24/7 .....	£773
Band 4 .....	£783
Band 5 .....	£856
Band 6 .....	£885
Band 7 .....	£911
Leather Group 1 .....	POA



**AX24/7A22**  
High Back with A22 Multi-function Push Button Arms

Band 1 .....	£877
Band 2 .....	£893
Band 3 - 24/7 .....	£899
Band 4 .....	£906
Band 5 .....	£982
Band 6 .....	£1,009
Band 7 .....	£1,037
Leather Group 1 .....	POA



Camira 24/7 Flax Eternity FYR18 (Band 3)

5 Year  
Guarantee

# TAMPER PROOF TASK & VISITOR

Tamper Proof seating selection.

- Ideal for schools, colleges, libraries and public areas.
- Extremely durable / robust.
- Easy to use.
- Tamper Proof fittings.
- TPPBC - Push button height adjustment.

Product Features



Frame Options

290 - Available in Black / Grey / White / Silver



**TPPBC**  
Push Button Tamper Proof

Band 1 .....	£293
Band 2 .....	£306
Band 3 .....	£323
Band 4 .....	£342
Band 5 .....	£357
Band 6 .....	£377
Band 7 .....	£390
Leather Group 1 .....	POA



**290**  
Heavy Duty Student  
Chair - Non Tilt

Band 1 .....	£293
Band 2 .....	£306
Band 3 .....	£323
Band 4 .....	£342
Band 5 .....	£357
Band 6 .....	£377
Band 7 .....	£390
Leather Group 1 .....	POA



Gabriel Repetto 02901 (Band 2)

# INDUSTRIAL TASK & VISITOR



This family of chairs and stools are produced with moulded polyurethane seats and backs.

- Wipe-clean, chemical resistant surfaces.
- Ideal for laboratory, commercial and health care use.
- Textured surface helps prevent slipping when seated.



**INPU/16**  
Operator Task Chair with Gas Height Adjustment and Back Rest Adjustment in Height and Rake  
£303



**INDPU/16**  
High Level Work Chair with Gas Height Adjustable and Back Rest Adjustment in Height and Rake (Glides)  
£386



**INS/P**  
Perch Stool with Gas Height Adjustment (Glides)  
£238



**INDS/P**  
High Level Perch Stool with Gas Height Adjustment (Glides)  
£322



Task & Visitor  
Seating



# LS37 TASK & VISITOR

Thanks to its active movement, LS37 helps to provide a healthy sitting experience. With its' smooth motion and practicality, the pivoting base allows the user to sit with an open leg angle which helps to alleviate pressure placed on hips and lower back, as well as feet, ankles and legs; comparative to the detriment of sitting with a traditional posture. The stool can also be used as a 'perch' when using a Sit/Stand desk with its height adjustable column.

### Product Features



### Movement



LS37A  
Pivoting Stool

Band 1 .....	£589
Band 2 .....	£609
Band 3 .....	£630
Band 4 .....	£652
Band 5 .....	£670
Band 6 .....	£692
Band 7 .....	£713



# INTRODUCTION

## CONFERENCE, MEETING & CAFÉ

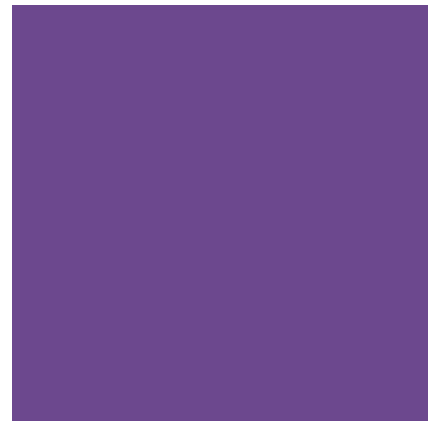

Conference,  
Meeting &  
Cafe Seating



Selected items within this range are stackable. These items are identified within the product description.

For further information regarding stacking quantity - Please contact our Sales Department.



Items are available in a variety of fabrics. A number of products possess certain upholstery restrictions - these are therefore available in selected fabrics only and are identified within this brochure.

For further information regarding fabric suitability - Please contact our Sales Department.



Arms are available on designated product ranges as indicated within the relevant product thumbnails. Colour / Finish options are indicated on relevant product pages - where applicable.

For further information regarding Arm options - Please contact our Sales Department.



Feet are available on designated product ranges as indicated within the relevant product thumbnails. Colour / Finish options are indicated on relevant product pages - where applicable.

For further information regarding Feet options - Please contact our Sales Department.



Items include Reflex Foam Structure as standard.

Level 'S' tested to BS5459: Part 2: 2000.

Extreme Comfort.

Consistent Shape Retention.

Durability and long life.

Excellent Fire Retardant Properties.

We recommend that you request fabric samples prior to ordering.

Two tone upholstery is available on selected products. Please contact our Sales Department for further information.

You can find dimensions for all products in the technical data section of this brochure.

Please Note: All images shown are for illustrative purposes.

Some aspects of certain products may differ. Please contact our customer services department with any queries.

# KAST

## CONFERENCE, MEETING & CAFÉ



Kast is characterised by a single piece shell with a choice of mechanism which is concealed within the seat and simply adjusted by semi concealed triggers. Kast's strength lies in its innovative high resistance inner structure, adding to the environmental story of the chair.

Available with or without elegant die-cast aluminium armrests in a selection of colours which move with the body of the chair. With the technology hidden inside the shell and covered by a wide range of fabrics the underside is tidy and compact.

### Product Features



### Frame Colours



### Additional Information

The weight activated **Synchronized Mechanism** versions offer customisable height adjustability with both seat and back angle adjustment.

Tilt angles:  
18° backrest (Backrest angle locks in 3 positions)  
1° seat

The **Visitor Mechanism** provides a fixed height seat with free-float movement.



**KASFMA2**  
High Back Pyramid Base  
Synchronized Mechanism

Band 3 .....	£1,552
Band 4 .....	£1,587
Band 5 .....	£1,625
Band 6 .....	£1,662
Band 7 .....	£1,694
Leather Group 1 .....	£2,056



**KASFMA1**  
High Back 5 Star Castor Base  
Synchronized Mechanism

Band 3 .....	£1,503
Band 4 .....	£1,539
Band 5 .....	£1,579
Band 6 .....	£1,616
Band 7 .....	£1,648
Leather Group 1 .....	£1,925



**KASVMA2**  
High Back Pyramid Base  
Visitor Mechanism

Band 3 .....	£1,484
Band 4 .....	£1,519
Band 5 .....	£1,559
Band 6 .....	£1,593
Band 7 .....	£1,626
Leather Group 1 .....	£1,979



**KASLBFMA2**  
Medium Back  
Pyramid Base  
Synchronized Mechanism

Band 3 .....	£1,518
Band 4 .....	£1,542
Band 5 .....	£1,568
Band 6 .....	£1,591
Band 7 .....	£1,612
Leather Group 1 .....	£2,022



**KASLBFMA1**  
Medium Back 5 Star  
Castor Base  
Synchronized Mechanism

Band 3 .....	£1,415
Band 4 .....	£1,434
Band 5 .....	£1,461
Band 6 .....	£1,484
Band 7 .....	£1,506
Leather Group 1 .....	£1,834



**KASLBVMA2**  
Medium Back  
Pyramid Base  
Visitor Mechanism

Band 3 .....	£1,416
Band 4 .....	£1,437
Band 5 .....	£1,462
Band 6 .....	£1,485
Band 7 .....	£1,507
Leather Group 1 .....	£1,911



5 Year  
Guarantee

NEW  
PRODUCT

# KAST CONFERENCE, MEETING & CAFÉ



Conference,  
Meeting &  
Café Seating

# LC11 SLED

## CONFERENCE, MEETING & CAFÉ



The LC11 collection is a contemporary family of chairs offering an elegantly curved, single-piece shell with a variety of frame possibilities. The clean-lined sled frame option accentuates the stool's simplicity and with a choice of two heights, can be matched to most worksurfaces.

Please note vinyl fabrics are subject to a surcharge, please contact our sales department for further information.

### Product Features



### Plastic Colours



### Metal Frame Colours



### Additional Information

Available in a variety of fabrics.



**LC11M1**  
Sled Base  
650mm Seat Height  
Chrome Frame  
Price ..... £462

**LC11M2**  
Sled Base  
650mm Seat Height  
Chrome Frame Upholstered  
Band 1 ..... £943  
Band 2 ..... £961  
Band 3 ..... £988  
Band 4 ..... £1,009  
Band 5 ..... £1,037  
Band 6 ..... £1,059  
Band 7 ..... £1,082

Vinyl Surcharge £121

**LC11N1**  
Sled Base  
800mm Seat Height  
Chrome Frame  
Price ..... £477

**LC11N2**  
Sled Base  
800mm Seat Height  
Chrome Frame Upholstered  
Band 1 ..... £960  
Band 2 ..... £977  
Band 3 ..... £1,002  
Band 4 ..... £1,025  
Band 5 ..... £1,051  
Band 6 ..... £1,072  
Band 7 ..... £1,097

Vinyl Surcharge £121

Conference,  
Meeting &  
Café Seating

2 Year  
Guarantee

# LC11 SLED CONFERENCE, MEETING & CAFÉ



Conference,  
Meeting &  
Café Seating

# LC11 STAR CONFERENCE, MEETING & CAFÉ



The LC11 collection is a contemporary family of chairs offering an elegantly curved, single-piece shell with a variety of frame possibilities. When specified with the sleek pyramidal four and five star bases, the chairs come to life; ranging from simple swivel movement to mobile, gas height adjustability actions. Frames are available with either simple glides or stylish castors.

Please note vinyl fabrics are subject to a surcharge, please contact our sales department for further information.

### Product Features



Additional Information  
Available in a variety of fabrics.

### Metal Frame Colours



**LC11F3**  
4 Star 180° Swivel  
Black or White Frame  
Upholstered

Band 1 .....	£1,179
Band 2 .....	£1,197
Band 3 .....	£1,221
Band 4 .....	£1,244
Band 5 .....	£1,272
Band 6 .....	£1,293
Band 7 .....	£1,316

Vinyl Surcharge £121



**LC11G3**  
4 Star 360° Swivel  
Black or White Frame  
Upholstered

Band 1 .....	£1,179
Band 2 .....	£1,197
Band 3 .....	£1,221
Band 4 .....	£1,244
Band 5 .....	£1,272
Band 6 .....	£1,293
Band 7 .....	£1,316

Vinyl Surcharge £121



**LC11Q3**  
5 Star 360° Swivel  
Black or White Frame with Gas  
Lift and Soft Rubber Castors  
Upholstered

Band 1 .....	£1,278
Band 2 .....	£1,294
Band 3 .....	£1,320
Band 4 .....	£1,343
Band 5 .....	£1,369
Band 6 .....	£1,391
Band 7 .....	£1,413

Vinyl Surcharge £121



**LC11Q4**  
5 Star 360° Swivel  
Polished Frame with Gas Lift  
and Soft Rubber Castors  
Upholstered

Band 1 .....	£1,369
Band 2 .....	£1,387
Band 3 .....	£1,409
Band 4 .....	£1,433
Band 5 .....	£1,459
Band 6 .....	£1,482
Band 7 .....	£1,505

Vinyl Surcharge £121



Kvadrat Canvas 2 0954 (Band 4) with White 4 Star Swivel Base



# LC11 WOOD CONFERENCE, MEETING & CAFÉ

The LC11 collection is a contemporary family of chairs offering an elegantly curved, single-piece shell.

The sculpted polymer shell is available in an assortment of colours or can be specified in a selection of upholstery fabrics, whilst the wooden frames are offered in two styles. These can be specified in either complementary woodgrain or opaque finishes that add a natural warmth to each product.

Please note vinyl fabrics are subject to a surcharge, please contact our sales department for further information.

### Product Features



#### Plastic Colours



#### Wood Frame Colours



#### Additional Information

Available in a variety of fabrics.



LC11H1  
Wooden 4 Leg

Price ..... £429



LC11H2  
Wooden 4 Leg  
Upholstered

Band 1 .....	£912
Band 2 .....	£932
Band 3 .....	£957
Band 4 .....	£979
Band 5 .....	£991
Band 6 .....	£1,006
Band 7 .....	£1,051

Vinyl Surcharge £121



Sky Blue and Grey Plastic with Natural Legs

# LC11 CHROME

## CONFERENCE, MEETING & CAFÉ



The LC11 collection is a contemporary family of chairs offering an elegantly curved, single-piece shell with a variety of frame possibilities. Steel framed chairs are available in either four or sled legged options that are styled to match the sweeping shape of the seat. Chrome finished models are designed to stack and the sled framed chairs are offered with and without arms.

Please note vinyl fabrics are subject to a surcharge, please contact our sales department for further information.

### Product Features



**Additional Information**  
Painted frames available on 4 Leg only and coordinate with matching shells.  
Minimum order quantity - multiples of 2

### Plastic Colours



### Metal Frame Colours



**LC11A1**  
Chrome 4 Leg Frame

Price ..... £325



**LC11B1**  
Chrome Sled Frame  
(Stacks 6 as standard or 10 per Trolley)

Price ..... £409



**LC11C1**  
Chrome Sled Frame with Arms  
(Stacks 8 as standard or 10 per Trolley)

Price ..... £468



**LC11D**  
Sled Link in Grey

Price ..... £220



**LC11E**  
Trolley in Satin Steel

Price ..... £492

2 Year  
Guarantee

# LC11 CHROME

CONFERENCE, MEETING & CAFÉ



From L/R White Plastic with Chrome 4 Leg Frame and Grey Plastic with Chrome Sled Frame

Conference,  
Meeting &  
Café Seating

# LC11 STOOL

## CONFERENCE, MEETING & CAFÉ



The LC11 collection is a contemporary family of chairs offering an elegantly curved, single-piece shell with a variety of frame possibilities. The sculpted polymer shell is available in an assortment of colours or can be specified in a selection of upholstery fabrics, whilst the wooden frames are offered in two heights matching the style of the LC11H series. These can be specified in either complementary woodgrain or opaque finishes that add a natural warmth to each product.

Please note vinyl fabrics are subject to a surcharge, please contact our sales department for further information.

### Product Features



#### Plastic Colours



#### Wood Frame Colours



#### Additional Information

Footrest available in Chrome only.



LC11K1  
Wooden 4 Leg  
650mm Seat Height

Price ..... £554



LC11K2  
Wooden 4 Leg  
660mm Seat Height  
Upholstered

Band 1 ..... £1,037  
Band 2 ..... £1,052  
Band 3 ..... £1,077  
Band 4 ..... £1,101  
Band 5 ..... £1,129  
Band 6 ..... £1,150  
Band 7 ..... £1,171

Vinyl Surcharge £121



LC11L1  
Wooden 4 Leg  
800mm Seat Height

Price ..... £598



LC11L2  
Wooden 4 Leg  
810mm Seat Height  
Upholstered

Band 1 ..... £1,082  
Band 2 ..... £1,098  
Band 3 ..... £1,123  
Band 4 ..... £1,145  
Band 5 ..... £1,171  
Band 6 ..... £1,195  
Band 7 ..... £1,217

Vinyl Surcharge £121



2 Year  
Guarantee

# LC11 STOOL

CONFERENCE, MEETING & CAFÉ



Conference,  
Meeting &  
Café Seating

From L/R Panaz Cadet Zest 901 Silver (Band 2) with Bleached Beech Legs and Kvadrat Steelcut 2 0545 (Band 3) with Graphite Legs

# LC11 GAS

## CONFERENCE, MEETING & CAFÉ



The LC11 collection is a contemporary family of chairs offering an elegantly curved, single-piece shell with a variety of frame possibilities. The LC11P stools are adjustable with a simple 'one-touch' action, allowing them to be raised to the desired heights. They are fitted with a flat base and foot ring that enables users to swivel in a complete circle when seated. As with the other models within the LC11 family, the seat shells are offered in an assortment of colours or fully upholstered.

Please note vinyl fabrics are subject to a surcharge, please contact our sales department for further information.

### Product Features



Additional Information  
Available in a variety of fabrics.

### Plastic Colours



### Metal Frame Colours



**LC11P1**  
650mm - 840mm Seat Height  
Gas Lift  
Price ..... £1,021

**LC11P2**  
660mm - 840mm Seat Height  
Gas Lift Upholstered

Band 1 .....	£1,505
Band 2 .....	£1,520
Band 3 .....	£1,546
Band 4 .....	£1,570
Band 5 .....	£1,596
Band 6 .....	£1,619
Band 7 .....	£1,640



Conference,  
Meeting &  
Café Seating



# LC17 WOOD CONFERENCE, MEETING & CAFÉ

The LC17 is part dining chair, part easy chair, but wholly suitable for all relaxed situations. The upholstered seat is as comfortable as an armchair, but the 4-legged wooden frame gives it a streamlined design, allowing it to be used as a dining chair.

Please note vinyl fabrics are not available.

### Product Features



### Wood Frame Colours



### Additional Information

Available in a variety of fabrics.



LC17A  
Wooden 4 Leg

Band 1 .....	£1,466
Band 2 .....	£1,489
Band 3 .....	£1,522
Band 4 .....	£1,554
Band 5 .....	£1,587
Band 6 .....	£1,640
Band 7 .....	£1,649



From L/R Camira Blazer Cardiff CUZ1N and Camira Blazer Dunhurst CUZ58 (Band 4) with White Legs

# LC18 WOOD

## CONFERENCE, MEETING & CAFÉ



The LC18 stool is designed to suit all interior needs. Its ergonomic foam padded seat provides maximum comfort and is an excellent choice of stool for kitchens and lounge bars.

### Product Features



### Wood Frame Colours



Natural  
Oak

### Additional Information

Footrest available in Chrome only. Available in a variety of fabrics.



LC18C

Wooden 4 Leg Pyramid  
670mm Seat Height

Band 1 .....	£1,091
Band 2 .....	£1,098
Band 3 .....	£1,109
Band 4 .....	£1,120
Band 5 .....	£1,130
Band 6 .....	£1,140
Band 7 .....	£1,152



LC18D

Wooden 4 Leg Pyramid  
820mm Seat Height

Band 1 .....	£1,143
Band 2 .....	£1,152
Band 3 .....	£1,160
Band 4 .....	£1,170
Band 5 .....	£1,180
Band 6 .....	£1,192
Band 7 .....	£1,201



Conference,  
Meeting &  
Cafe Seating

From L/R Camira Era Everlasting CSE10 (Band 1) and Camira Era Aeon CSE20 (Band 1) with Natural Oak Legs

2 Year  
Guarantee

# LC18 WOOD CONFERENCE, MEETING & CAFÉ



Conference,  
Meeting &  
Café Seating

# LG4 PLASTIC CONFERENCE, MEETING & CAFÉ



The LG4 collection has been developed to add modern style, comfort and practicality to any interior. Beautiful design is complemented by utilising the latest materials science to provide lightweight yet strong models that will stand the test of time. The LG4E1 offers a single piece, sculpted seat shell that is available in an array of striking colours. The stylised moulded four legged frame pitches the seat at the perfect angle and is available in simple black or white options.

### Plastic Seat Colours

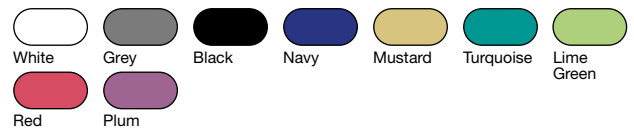

### Plastic Frame Colours



LG4E1  
4 Leg Plastic Frame

Price ..... £310



LG4E1UPH  
Upholstered 4 Leg Plastic Frame

Band 1 ..... £391  
 Band 2 ..... £420  
 Band 3 ..... £457  
 Band 4 ..... £490  
 Band 5 ..... £530  
 Band 6 ..... £563  
 Band 7 ..... £598



Turquoise, Plum and Mustard Plastic Seat with Black Plastic Frame



# LG4 WOOD CONFERENCE, MEETING & CAFÉ

The LG4 collection has been developed to add modern style, comfort and practicality to any interior. Beautiful design is complemented by utilising the latest materials science to provide lightweight yet strong models that will stand the test of time.

### Plastic Seat Colours

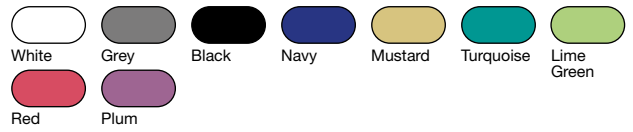

### Wood Frame Colours



**LG4C1**  
Wooden 4 Leg

Price ..... £272



**LG4K1**  
Wooden 680mm Seat Height

Price ..... £341



**LG4C1UPH**  
Upholstered

Band 1 ..... £361  
Band 2 ..... £388  
Band 3 ..... £425  
Band 4 ..... £460  
Band 5 ..... £497  
Band 6 ..... £532  
Band 7 ..... £556



**LG4K1UPH**  
Upholstered 680mm Seat Height

Band 1 ..... £387  
Band 2 ..... £412  
Band 3 ..... £450  
Band 4 ..... £485  
Band 5 ..... £525  
Band 6 ..... £558  
Band 7 ..... £593



Plum, Grey and Lime Green Plastic Seat with Beech Frame

Conference,  
Meeting &  
Café Seating

# LG4 CHROME

## CONFERENCE, MEETING & CAFÉ



The LG4 collection has been developed to add modern style, comfort and practicality to any interior. Beautiful design is complemented by utilising the latest materials science to provide lightweight yet strong models that will stand the test of time. In its simplest form, this family offers steel four legged or sled framed options featuring a clean, bright chrome finish. These lightweight, yet durable chairs are designed to stack; simply reducing the space taken when not in use.

### Plastic Seat Colours

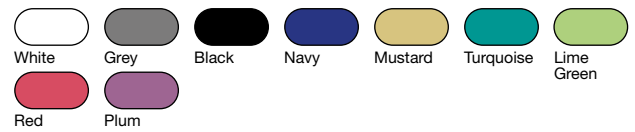

### Metal Frame Colours



### Product Features



**LG4A1**  
Chrome 4 Leg

Price ..... £257



**LG4B1**  
Chrome Sled Frame

Price ..... £272



**LG4M1**  
Chrome Sled Frame  
655mm Seat Height

Price ..... £307



**LG4J1**  
Chrome Sled Frame  
760mm Seat Height

Price ..... £341



**LG4A1UPH**  
Upholstered  
Chrome 4 Leg

Band 1 ..... £347  
Band 2 ..... £376  
Band 3 ..... £412  
Band 4 ..... £447  
Band 5 ..... £486  
Band 6 ..... £520  
Band 7 ..... £556



**LG4B1UPH**  
Upholstered  
Chrome Sled Frame

Band 1 ..... £367  
Band 2 ..... £396  
Band 3 ..... £433  
Band 4 ..... £467  
Band 5 ..... £507  
Band 6 ..... £540  
Band 7 ..... £575



**LG4M1UPH**  
Upholstered  
Chrome Sled Frame  
Mid Height

Band 1 ..... £367  
Band 2 ..... £393  
Band 3 ..... £429  
Band 4 ..... £465  
Band 5 ..... £505  
Band 6 ..... £539  
Band 7 ..... £574



**LG4J1UPH**  
Upholstered  
Chrome Sled Frame  
760mm Seat Height

Band 1 ..... £397  
Band 2 ..... £425  
Band 3 ..... £463  
Band 4 ..... £496  
Band 5 ..... £534  
Band 6 ..... £571  
Band 7 ..... £604

Conference,  
Meeting &  
Café Seating



2 Year  
Guarantee

NEW  
PRODUCT

# CONFERENCE, MEETING & CAFÉ



From L/R White Plastic with Chrome Sled Frame and Red Plastic with Chrome 4 Leg Frame.

Conference,  
Meeting &  
Café Seating

# LS36

## CONFERENCE, MEETING & CAFÉ

2 Year Guarantee

LS36 combines one single shell with several different frames, creating a versatile and multipurpose seating family. LS36 is suitable for use in meeting, waiting and conference rooms, and also in hospitality where it is perfect for cafeterias and bars. Upholstered seat pad is available in a variety of fabrics.

### Plastic Shell Colours



### Metal Frame Colours



### Product Features



### Additional Information

Upholstered seat pads (SP) available in a variety of fabrics.



**LS36B**  
4 Leg Frame

Price Without Seat Pad ..... £125

**LS36BSP**  
4 Leg Frame with Seat Pad

Band 1 .....	£188
Band 2 .....	£202
Band 3 .....	£219
Band 4 .....	£237
Band 5 .....	£255
Band 6 .....	£272
Band 7 .....	£288
Leather Group 1 .....	POA

**LS36A**  
A Frame

Price Without Seat Pad .....£146

**LS36ASP**  
A Frame with Seat Pad

Band 1 .....	£210
Band 2 .....	£224
Band 3 .....	£242
Band 4 .....	£258
Band 5 .....	£276
Band 6 .....	£293
Band 7 .....	£309
Leather Group 1 .....	POA

**LS36C**  
Sled Leg Frame

Price Without Seat Pad .....£181

**LS36CSP**  
Sled Leg Frame with Seat Pad

Band 1 .....	£245
Band 2 .....	£259
Band 3 .....	£277
Band 4 .....	£294
Band 5 .....	£314
Band 6 .....	£330
Band 7 .....	£346
Leather Group 1 .....	POA

**LS36D**  
4 Leg Stool  
755mm Seat Height

Price Without Seat Pad ..... £247

**LS36DSP**  
4 Leg Stool with Seat Pad

Band 1 .....	£312
Band 2 .....	£324
Band 3 .....	£343
Band 4 .....	£360
Band 5 .....	£379
Band 6 .....	£395
Band 7 .....	£412
Leather Group 1 .....	POA



From L/R Grey with Chrome A Frame, Avocado with White 4 Leg Frame, White with Chrome Sled Leg Frame and Black with Chrome Sled Leg Frame

2 Year Guarantee

# LG1 CONFERENCE, MEETING & CAFÉ

This stylised collection has been developed to offer a distinctive look whilst providing comfort and longevity. The moulded shapes within the shell accentuate the 'plank' effect of the design and create a slip-free surface on which to sit. In its simplest form, this family offers steel four legged or sled framed options featuring a clean, bright chrome finish. These lightweight, yet durable chairs are designed to stack; simply reducing the space taken when not in use.

### Plastic Seat Colours

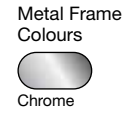

Additional Information  
Chairs and stool stack 4 high.



LG1A1  
Chrome 4 Leg

Price ..... £240



LG1B1  
Chrome Sled Frame

Price ..... £257



LG1G1  
Chrome Sled Frame  
760mm Seat Height

Price ..... £302



LG1E1  
4 Leg Plastic Frame

Price ..... £297



From L/R White Plastic with Chrome Sled Leg Frame and Turquoise with Chrome 4 Leg Frame

Conference,  
Meeting &  
Café Seating

# QUS

## CONFERENCE, MEETING & CAFÉ



Qus is a vintage-inspired range. The elegant polypropylene shell makes the Qus compact, strong and light, whilst conserving comfort and practicality for daily use. Being available in a variety of colours with multiple frame and seat upholstery options makes Qus the right solution for indoor modern community spaces.

### Product Features



#### Plastic Colours

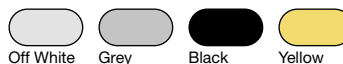

#### Metal Frame Colours



Chrome

#### Wood Frame Colours



Natural

#### Additional Information

The tube frame options (including stools) stack up to 5 chairs high. Optional seat upholstery available in a variety of fabrics. Optional linking device



**QUSL**  
Chrome 4 Leg Frame

Price ..... £140



**QUS4**  
Chrome Star Base

Price ..... £293



**QUSRT**  
Chrome Sled Frame  
with Right Hand Writing Tablet

Price ..... £379



**QUSLT**  
Chrome Sled Frame  
with Left Hand Writing Tablet

Price ..... £379



**QUSC**  
Chrome Sled Frame

Price ..... £205



**QUSS8**  
Chrome Sled Frame  
630mm Seat Height

Price ..... £229



**QUSW**  
Natural Wooden 4 Leg

Price ..... £350

**SP**  
Chrome Seat Upholstry Kit

Band 1 ..... £60  
Band 2 ..... £65  
Band 3 ..... £78  
Band 4 ..... £92  
Band 5 ..... £104  
Band 6 ..... £115  
Band 7 ..... £126

2 Year  
Guarantee

# QUS CONFERENCE, MEETING & CAFÉ



Conference,  
Meeting &  
Café Seating

From L/R Black Plastic with Wooden 4 Leg Frame and Yellow Plastic with Chrome 4 Leg Frame

# COSO

## CONFERENCE, MEETING & CAFÉ



Coso is a family of products made up of chairs, armchairs and stools, with fiberglass polypropylene shells and metal frames. The idea is to offer a collection of products intentionally limited to a few base models, thanks to the essential design's versatility and to the range of colour combinations between shells and frames. Ability to stack all models.

### Plastic Seat Colours



### Metal Frame Colours



### Product Features



**COS4**  
Chrome 4 Leg Frame

Price ..... £211



**COS4A**  
Chrome 4 Leg with Arms

Price ..... £252



**COS65**  
Chrome Sled Frame  
655mm Seat Height

Price ..... £293



**COS75**  
Chrome Sled Frame  
755mm Seat Height

Price ..... £315



White Plastic and Grey Plastic with Chrome 4 Leg Frame

Conference,  
Meeting &  
Cafe Seating

2 Year  
Guarantee

# LG33 CONFERENCE, MEETING & CAFÉ

The LG33 collection has been refined to add modern style, comfort and practicality to any interior. Beautiful design is complemented by utilising polypropylene to provide a lightweight yet strong model that will stand the test of time. These chairs surround users in their organic curves, adding to the feeling of comfort.

#### Plastic Seat Colours

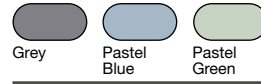

#### Metal Frame Colours



#### Wood Frame Colours



LG33A  
Skid Frame

Price ..... £320



LG33B  
Wooden 4 Leg Frame

Price ..... £379



From L/R Pastel Blue Plastic with Wooden 4 Leg Frame and Grey Plastic with Black Skid Frame

# GD2 STOOL

## CONFERENCE, MEETING & CAFÉ



This retro-modern family of stools offers the perfect solution when wanting style with substance. The solid wood frames are offered in natural or stained options allowing them to be suited with their surroundings, whilst the seats can be specified in a show-wood or upholstered finishes. Available in low or high models to suit dining or poseur height tables.

### Product Features



### Wood Frame Colours



### Additional Information

Upholstered Seat Cushion available in a variety of fabrics.



GD2A1

Show Wood Square High Stool

Price ..... £659



GD2A2

Show Wood Square Low Stool

Price ..... £594



GD2A5

Show Wood High Bench

Price ..... £1,273



GD2A6

Show Wood Low Bench

Price ..... £1,193



GD2B1

Square High Stool with Upholstered Seat

Band 1 ..... £700  
 Band 2 ..... £719  
 Band 3 ..... £741  
 Band 4 ..... £762  
 Band 5 ..... £787  
 Band 6 ..... £809  
 Band 7 ..... £829



GD2B2

Square Low Stool with Upholstered Seat

Band 1 ..... £637  
 Band 2 ..... £654  
 Band 3 ..... £677  
 Band 4 ..... £699  
 Band 5 ..... £724  
 Band 6 ..... £745  
 Band 7 ..... £766



GD2B5

High Bench with Upholstered Seat

Band 1 ..... £1,356  
 Band 2 ..... £1,391  
 Band 3 ..... £1,447  
 Band 4 ..... £1,495  
 Band 5 ..... £1,551  
 Band 6 ..... £1,599  
 Band 7 ..... £1,649



GD2B6

Low Bench with Upholstered Seat

Band 1 ..... £1,277  
 Band 2 ..... £1,311  
 Band 3 ..... £1,369  
 Band 4 ..... £1,418  
 Band 5 ..... £1,472  
 Band 6 ..... £1,520  
 Band 7 ..... £1,570

Conference, Meeting & Cafe Seating



5 Year  
Guarantee

# GD2 STOOL

CONFERENCE, MEETING & CAFÉ



Svensson Iconic 5553 (Band 5) with Natural Ash Frame

Conference,  
Meeting &  
Café Seating

# GD3 STOOL

## CONFERENCE, MEETING & CAFÉ



This stylishly simple family of stools offers visually light-weight models that are at home in break-out or modern working environments alike. Fully upholstered options can be specified in a selection of vibrant or muted toned fabrics to blend or accent colours around them. Available in low or high models to suit dining or poseur height tables.

### Product Features



### Metal Frame Colours

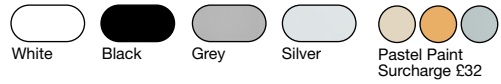

**GD3B1**  
High Stool with  
Upholstered Seat

Band 1 .....	£376
Band 2 .....	£389
Band 3 .....	£408
Band 4 .....	£429
Band 5 .....	£449
Band 6 .....	£465
Band 7 .....	£487



**GD3B2**  
Low Stool with  
Upholstered Seat

Band 1 .....	£321
Band 2 .....	£335
Band 3 .....	£356
Band 4 .....	£376
Band 5 .....	£395
Band 6 .....	£412
Band 7 .....	£433



**GD3B3**  
Low Stool with  
Upholstered Seat

Band 1 .....	£343
Band 2 .....	£357
Band 3 .....	£366
Band 4 .....	£389
Band 5 .....	£406
Band 6 .....	£424
Band 7 .....	£438



From L/R Kvadrat Canvas 2 0684 (Band 4) and Kvadrat Canvas 2 0644 (Band 4) with White Frame

Conference,  
Meeting &  
Café Seating

5 Year  
Guarantee

# LG27 CONFERENCE, MEETING & CAFÉ

This simply styled model with a fully upholstered finish brings both choice and a sense of fun to the workplace. With its light-weight construction and ability to stack vertically, the LG27 offers true agility when arranging your environment. Just add colour.

## Product Features



## Additional Information

Stackable up to 6 high. Available in a variety of fabrics.



LG27  
Upholstered 460mm Seat  
Height

Band 1 .....	£476
Band 2 .....	£503
Band 3 .....	£536
Band 4 .....	£569
Band 5 .....	£606
Band 6 .....	£637
Band 7 .....	£668



Conference,  
Meeting &  
Café Seating

LG24 in Kvadrat Remix 2 412, 422, 452,163 (Band 4) and Steps in Kvadrat Remix 2 422, 452 (Band 4)

# GC7 CONFERENCE, MEETING & CAFÉ



The GC7 range of chairs offers comfort and flexibility with a sleek profile ideally suited to today's modern office spaces. Our GC7 chairs are available in a four different coloured shells with integrated armrests and a gracefully curved backrest for optimal support. We make it easy to create a totally customised look for your workspace by offering eight interchangeable base options and a number of seat upholstery choices.

T. Optional Tilt Mechanism available.  
(Suffix code with T. Example: GC7D2T)  
Surcharge.....£46

### Product Features



#### Plastic Colours



#### Frame Colours



**GC7A1**  
4 Leg Base

Band 1 .....	£345
Band 2 .....	£352
Band 3 .....	£363
Band 4 .....	£374
Band 5 .....	£386
Band 6 .....	£396
Band 7 .....	£405



**GC7B1**  
Cantilever Base

Band 1 .....	£469
Band 2 .....	£477
Band 3 .....	£489
Band 4 .....	£497
Band 5 .....	£511
Band 6 .....	£520
Band 7 .....	£530



**GC7C1**  
Pyramid Base with Glides

Band 1 .....	£532
Band 2 .....	£541
Band 3 .....	£554
Band 4 .....	£561
Band 5 .....	£575
Band 6 .....	£585
Band 7 .....	£594



**GC7C2**  
Pyramid Base with Castors

Band 1 .....	£534
Band 2 .....	£543
Band 3 .....	£556
Band 4 .....	£563
Band 5 .....	£577
Band 6 .....	£588
Band 7 .....	£598



From L/R Camira Blazer Magdalene CUZ21 (Band 4) and Camira Blazer Stanford CUZ2R (Band 4) with White Pyramid Base



GC7D1

4 Star Base with Glides

Band 1 .....	£421
Band 2 .....	£428
Band 3 .....	£441
Band 4 .....	£451
Band 5 .....	£463
Band 6 .....	£472
Band 7 .....	£484



GC7D2

4 Star Base with Castors  
T

Band 1 .....	£432
Band 2 .....	£440
Band 3 .....	£451
Band 4 .....	£462
Band 5 .....	£472
Band 6 .....	£484
Band 7 .....	£493



GC7E1

5 Star Base with Glides

Band 1 .....	£442
Band 2 .....	£448
Band 3 .....	£462
Band 4 .....	£470
Band 5 .....	£484
Band 6 .....	£493
Band 7 .....	£504



GC7E2

5 Star Base with Castors  
T

Band 1 .....	£455
Band 2 .....	£463
Band 3 .....	£473
Band 4 .....	£485
Band 5 .....	£495
Band 6 .....	£507
Band 7 .....	£516



From L/R Camira Blazer Silverdale CUZ1J (Band 4) and Camira Blazer Magdalene CUZ21 (Band 4) with Black 5 Star Base on Castors

# GC5 CONFERENCE, MEETING & CAFÉ



The GC5 chair is transitional chair that supports agile learning environments where teaching and training modes are fluid and traditional chairs and desks just won't do. They are designed to combine mobile seating with personal storage whilst providing a robust surface which can be utilised for paperwork tasks, when using portable electronic devices or when moving from collaborative to individual working scenarios.

### Product Features



### Plastic Shell Colours



### Additional Information

Wheel base available in Grey only. Upholstered Seat Pad available in a variety of fabrics.



**GC5B1**  
Mobile Chair with Storage with Writing Tablet Plastic Shell

Price ..... £533



**GC5B2**  
Mobile Chair with Storage with Writing Tablet Upholstered Seat Pad

Band 1 .....	£598
Band 2 .....	£619
Band 3 .....	£644
Band 4 .....	£668
Band 5 .....	£697
Band 6 .....	£722
Band 7 .....	£746



From L/R Sky Blue and Yellow Plastic

The ultimate blend of style and comfort, Hour is a mix of wood and steel that provides the perfect statement. Seat and back shells are produced in profiled laminated plywood that have a lacquer finish for wipe-down durability. Upholstery fabrics for seat panels are available in a wide selection of patterns, colours & weaves, suitable for contract use in public areas.

Product Features



Wood Colours



Frame Colours



Additional Information

Available with an upholstered seat in a range of fabrics. Complimentary to Moment Tables.

Upholstery kit

Band 1 .....	£60	Band 5 .....	£104
Band 2 .....	£66	Band 6 .....	£115
Band 3 .....	£78	Band 7 .....	£126
Band 4 .....	£92		



HR1W  
Walnut 4 Leg

Price ..... £492



HR1N  
Natural 4 Leg

Price ..... £492



HR1SW  
Walnut 4 Leg  
725mm Seat Height

Price ..... £643



HR1SN  
Natural 4 Leg  
725mm Seat Height

Price ..... £643



Walnut 4 Leg

# LG31

## CONFERENCE, MEETING & CAFÉ



LG31 is a family of single-piece laminated shell chairs and stools in a choice of classic styles.

- Available with or without upholstered seat pads.
- Stool options available.
- Perfect for cafés, bistros, restaurants.

### Product Features



#### Metal Frame Colours



Black

#### Wood Colours



Black



Ash

### Additional Information

Upholstered seat pads available in a variety of fabrics.



LG31D  
4 Leg Frame

Price ..... £249



LG31C  
Sled Frame

Price ..... £249



LG31LS  
Sled Frame  
650mm Seat Height

Price ..... £363



LG31HS  
Sled Frame  
750mm Seat Height

Price ..... £377



From L/R Lacquered Ash and Black





LG31US  
4 Leg Frame  
with Upholstered Seat

Band 1 .....	£306
Band 2 .....	£321
Band 3 .....	£336
Band 4 .....	£350
Band 5 .....	£366
Band 6 .....	£379
Band 7 .....	£394



LG31CUS  
Sled Frame  
with Upholstered Seat

Band 1 .....	£306
Band 2 .....	£321
Band 3 .....	£336
Band 4 .....	£350
Band 5 .....	£366
Band 6 .....	£379
Band 7 .....	£394



LG31LSUS  
Sled Frame  
with Upholstered Seat  
650mm Seat Height

Band 1 .....	£421
Band 2 .....	£436
Band 3 .....	£451
Band 4 .....	£465
Band 5 .....	£479
Band 6 .....	£494
Band 7 .....	£510



LG31HSUS  
Sled Frame  
with Upholstered Seat  
750mm Seat Height

Band 1 .....	£435
Band 2 .....	£448
Band 3 .....	£464
Band 4 .....	£478
Band 5 .....	£493
Band 6 .....	£508
Band 7 .....	£522



From L/R Lacquered Ash with Camira Blazer Eynesbury CUZ2W (Band 4) Seat and Black with Camira Blazer Woodcroft CUZ2Z (Band 4) Seat

# CAFÉ & BISTRO

## CONFERENCE, MEETING & CAFÉ

5 Year  
Guarantee

Café & Bistro is a family of single-piece laminated shell chairs combined with a heavy-duty steel frame. Available in a choice of classic styles that are a unification of elegance with robust durability. Perfect for cafés, bistros and restaurants.

### Product Features



### Metal Frame Colours



Chrome

### Wood Colours



Natural



Natural  
Satin



American  
Walnut

### Additional Information

Chairs stackable where stated. Stackable up to 5 units high. Upholstered seat available in a variety of fabrics. Not stackable in vinyl/leather.



Conference,  
Meeting &  
Café Seating



**EG04N**  
4 Leg Natural Satin

Price .....£172



**EG04W**  
4 Leg American Walnut

Price .....£201



**EG05N**  
4 Leg Natural Satin with Fully Welded Frame

Price .....£220



**EG05W**  
4 Leg American Walnut with Fully Welded Frame

Price .....£246



**EG04NSP**  
4 Leg Upholstered Seat Natural Satin

Band 1 .....£228  
Band 2 .....£236  
Band 3 .....£256  
Band 4 .....£271  
Band 5 .....£285  
Band 6 .....£299  
Band 7 .....£316



**EG04WSP**  
4 Leg Upholstered Seat American Walnut

Band 1 .....£255  
Band 2 .....£262  
Band 3 .....£278  
Band 4 .....£293  
Band 5 .....£312  
Band 6 .....£325  
Band 7 .....£341



**EG05NSP**  
4 Leg Upholstered Seat Natural Satin with Fully Welded Frame

Band 1 .....£273  
Band 2 .....£282  
Band 3 .....£299  
Band 4 .....£316  
Band 5 .....£330  
Band 6 .....£345  
Band 7 .....£361



**EG05WSP**  
4 Leg Upholstered Seat American Walnut with Fully Welded Frame

Band 1 .....£298  
Band 2 .....£307  
Band 3 .....£325  
Band 4 .....£341  
Band 5 .....£355  
Band 6 .....£372  
Band 7 .....£386



**TVR1**  
4 Leg Natural Finish (Stackable)

Price .....£162



**TC34N**  
4 Leg Natural Finish (Stackable)

Price .....£176



**TC4D**  
4 Leg Natural Finish (Stackable)

Price .....£162



**TVR1SP**  
4 Leg Upholstered Seat Natural Finish (Stackable)

Band 1 .....£214  
Band 2 .....£227  
Band 3 .....£240  
Band 4 .....£258  
Band 5 .....£273  
Band 6 .....£287  
Band 7 .....£303



**TC34NSP**  
4 Leg Upholstered Seat Natural Finish (Stackable)

Band 1 .....£235  
Band 2 .....£246  
Band 3 .....£262  
Band 4 .....£277  
Band 5 .....£292  
Band 6 .....£307  
Band 7 .....£323



**TC4DSP**  
4 Leg Upholstered Seat Natural Finish (Stackable)

Band 1 .....£214  
Band 2 .....£227  
Band 3 .....£240  
Band 4 .....£258  
Band 5 .....£273  
Band 6 .....£287  
Band 7 .....£303

# VISA

## CONFERENCE, MEETING & CAFÉ



A modern take on a classic design; Visa with its choice of vibrant colours or natural beech finish makes a statement.

- At home in domestic or contract surroundings.
- Optional seat pad.
- Swivel base option.

### Product Features



### Plastic Colours

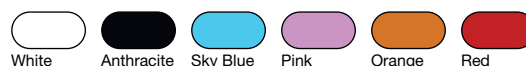

### Frame Colours



Chrome

### Wood Colours



Natural

### Optional Extras

MCT Trolley (for 4 leg versions only) £354



VIS1  
4 Leg Plastic (Stackable)  
£195



VISA  
4 Leg Plastic with Arms  
(Stackable)  
£206



VIS1SP  
4 Leg Upholstered Seat Pad  
(Stackable)

Band 1	£253
Band 2	£259
Band 3	£272
Band 4	£284
Band 5	£297
Band 6	£308
Band 7	£320
Leather Group 1	POA



VISASP  
4 Leg Upholstered Seat Pad  
with Arms (Stackable)

Band 1	£262
Band 2	£271
Band 3	£283
Band 4	£297
Band 5	£306
Band 6	£320
Band 7	£329
Leather Group 1	POA



VISASSP  
Swivel Chair Upholstered Seat  
Pad with Arms

Band 1	£352
Band 2	£358
Band 3	£373
Band 4	£384
Band 5	£396
Band 6	£410
Band 7	£418
Leather Group 1	POA



VISAS  
Swivel Chair with Arms  
£295

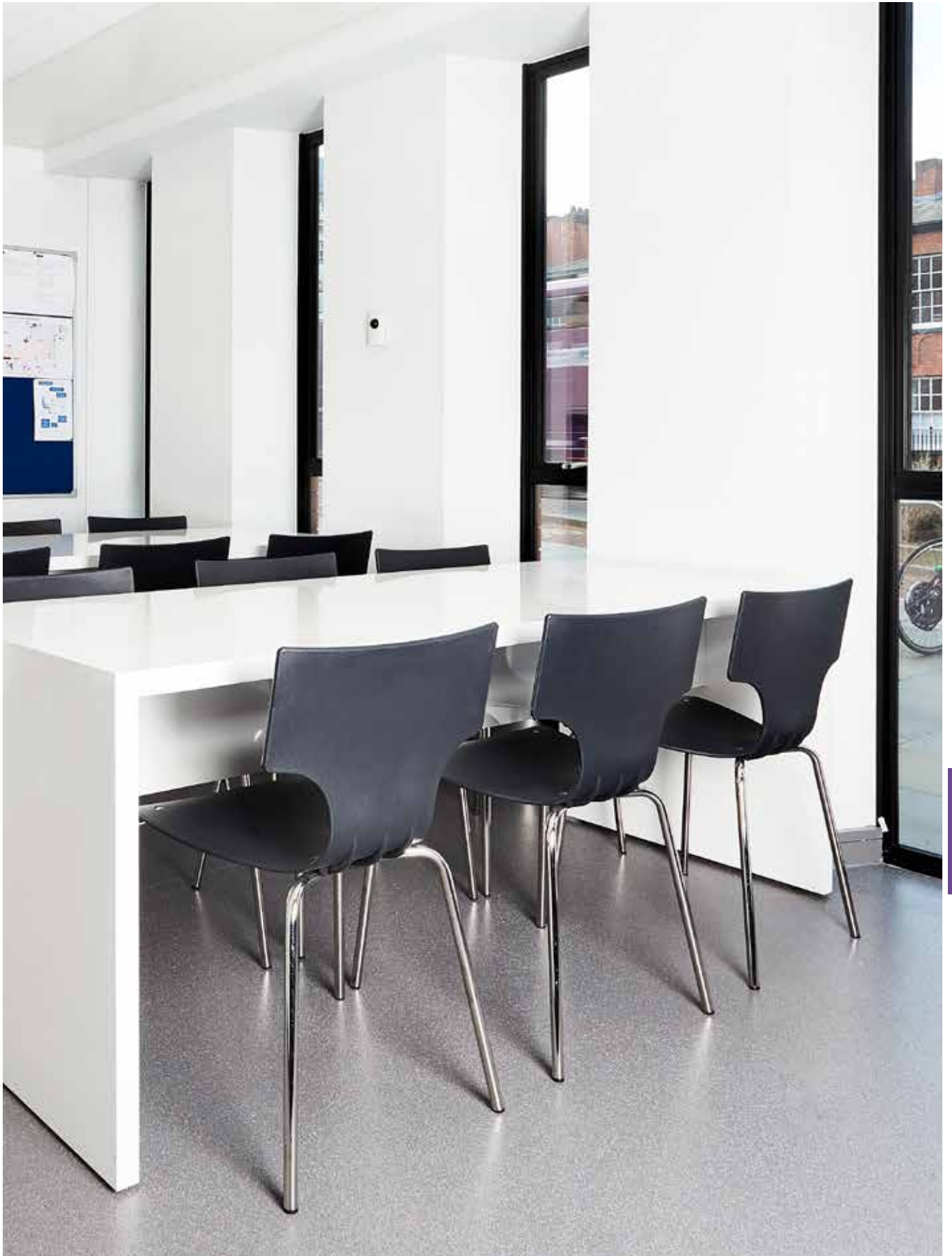

Black Plastic with Chrome 4 Leg

# GARO

## CONFERENCE, MEETING & CAFÉ

5 Year Guarantee

Garo is a pure and simple chair, created using quality polypropylene to make it not only lightweight and robust, but suitable for a number of diverse environments. The stackable smart design lends itself to everything from contemporary dining, to casual outdoor use.

### Product Features



### Plastic Seat Colours



### Additional Information

Stackable up to 4 chairs high. All outdoor products can fade or stain when left out in extreme weather conditions.



KARG1  
4 Leg

Price ..... £223



From L/R Nougat Plastic and White Plastic



# ONIO

## SOFT SEATING, RECEPTION & BREAKOUT

Onio's balanced pose is curved for comfort, a slender sloping back rest partnered with foam seat, make for a reassuring figure. An overall compact design provides ample scope for application, be that in lounge or waiting areas or breakout and meeting spaces.

### Product Features



### Please Note

Available in selected fabrics only - Please contact our Sales Department for further information.



ONIOU1  
Upholstered Tub Chair

Band 1 .....	£1,020
Band 2 .....	£1,102
Band 3 .....	£1,217
Band 4 .....	£1,323
Band 5 .....	£1,442
Band 6 .....	£1,546
Band 7 .....	£1,651



Conference,  
Meeting &  
Cafe Seating

# BRETEN

## CONFERENCE, MEETING & CAFÉ

5 Year  
Guarantee

This on-trend collection is perfect for those who want comfortable seating and a modern twist. Being lightweight and durable means Bretten can be easily moved, perfect for office or dining spaces, and is suitable for indoor and covered outdoor areas.

Metal Colours



Grey

Additional Information

All outdoor products can fade or stain when left out in extreme weather conditions.



**BRE1**  
Distressed 4 Leg

Price ..... £310



**BREHS**  
Distressed 4 Leg  
760mm Seat Height

Price ..... £377



Conference,  
Meeting &  
Café Seating





# MEROUX CONFERENCE, MEETING & CAFÉ

The Meroux collection is carefully crafted from sheet metal with a distressed look finish. Strong, durable, lightweight and stackable means Meroux is a favourite of cafés, dining areas and retro spaces. Suitable for indoor and covered outdoor areas.

### Paint Colours (£39 surcharge)



### Metal Colours



### Additional Information

Stackable up to four high. Surcharge for coloured paint finish with a minimum order quantity - 10 of the same item in the same colour finish. All outdoor products can fade or stain when left out in extreme weather conditions.



MER1  
4 Leg

Price ..... £255



MERLS  
4 Leg  
455mm Seat Height

Price ..... £196



MERHS  
4 Leg  
745mm Seat Height

Price ..... £236



Conference,  
Meeting &  
Café Seating

# VONA

## CONFERENCE, MEETING & CAFÉ



In keeping with our social responsibility, we introduce this sustainable chair design; a simple but unique chair made of recycled Felt (60% recycled PP bottles and 40% non-woven textile).

Vona is a conference chair that can be stored into vertical stacks. The seat consists of ergonomic triangular plates allowing comfortable sitting by adapting to the body.

### Product Features



#### Seat Colours



Grey

#### Frame Colours



Black

#### Additional Information

Stackable up to 3 chairs high. Seat pad only available in Gabriel Fame.



LS34A  
Sled Frame

Gabriel Fame ..... £624  
(Seat pad only)

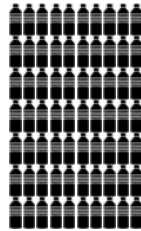

Gabriel Fame 68146 (Band 4) Seat Pad



# THEIA

## CONFERENCE, MEETING & CAFÉ

5 Year Guarantee

The Theia Chair is available with or without arms in a range of plastic colours and multiple finish variants also with the option of left or right handed writing tablets.

### Plastic Colours



### Frame Colours

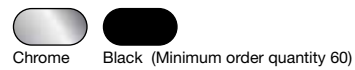

### Product Features



### Optional Extras

ETROL Trolley	£861
EBASK Storage Basket	£138



EBASK Storage Basket



White Plastic with Camira Blazer Scottsdale CUZ3E (Band 4) Seat and Back with Chrome Frame



**E11**  
Plastic Seat & Back  
(Stackable: Floor 20/Trolley 40)  
£217



**EIA**  
Plastic Seat & Back with Arms  
(Stackable: Floor 20/Trolley 40)  
£285



**EIART**  
Plastic Seat & Back with Arms  
& Writing Tablet (Right Hand)  
(Stackable: Floor 20/Trolley 40)  
(Remove Tablet to Stack)  
£408



**EIALT**  
Plastic Seat & Back with Arms  
& Writing Tablet (Left Hand)  
(Stackable: Floor 20/Trolley 40)  
(Remove Tablet to Stack)  
£408



**E11SP**  
Upholstered Seat  
(Stackable: Floor 15/Trolley 15)

Band 1 .....	£286
Band 2 .....	£297
Band 3 .....	£311
Band 4 .....	£326
Band 5 .....	£340
Band 6 .....	£355
Band 7 .....	£367
Leather Group 1 .....	POA



**EIASP**  
Upholstered Seat with Arms  
(Stackable: Floor 15/Trolley 15)

Band 1 .....	£345
Band 2 .....	£355
Band 3 .....	£369
Band 4 .....	£385
Band 5 .....	£396
Band 6 .....	£411
Band 7 .....	£425
Leather Group 1 .....	POA



**EIARTSP**  
Upholstered Seat with Arms &  
Writing Tablet (Right Hand)  
(Stackable: Floor 15/Trolley 15)  
(Remove Tablet to Stack)

Band 1 .....	£469
Band 2 .....	£477
Band 3 .....	£494
Band 4 .....	£508
Band 5 .....	£522
Band 6 .....	£536
Band 7 .....	£551
Leather Group 1 .....	POA



**EIALTSP**  
Upholstered Seat with Arms &  
Writing Tablet (Left Hand)  
(Stackable: Floor 15/Trolley 15)  
(Remove Tablet to Stack)

Band 1 .....	£469
Band 2 .....	£477
Band 3 .....	£494
Band 4 .....	£508
Band 5 .....	£522
Band 6 .....	£536
Band 7 .....	£551
Leather Group 1 .....	POA



**E11BP**  
Upholstered Seat & Back  
(Stackable: Floor 15/Trolley 15)

Band 1 .....	£332
Band 2 .....	£342
Band 3 .....	£360
Band 4 .....	£371
Band 5 .....	£387
Band 6 .....	£401
Band 7 .....	£415
Leather Group 1 .....	POA



**EIABP**  
Upholstered Seat & Back  
with Arms  
(Stackable: Floor 15/Trolley 15)

Band 1 .....	£392
Band 2 .....	£401
Band 3 .....	£417
Band 4 .....	£429
Band 5 .....	£445
Band 6 .....	£458
Band 7 .....	£473
Leather Group 1 .....	POA



**EIARTBP**  
Upholstered Seat & Back with  
Arms & Writing Tablet  
(Right Hand)  
(Stackable: Floor 15/Trolley 15)  
(Remove Tablet to Stack)

Band 1 .....	£517
Band 2 .....	£526
Band 3 .....	£539
Band 4 .....	£554
Band 5 .....	£569
Band 6 .....	£583
Band 7 .....	£598
Leather Group 1 .....	POA



**EIALTBP**  
Upholstered Seat & Back with  
Arms & Writing Tablet  
(Left Hand)  
(Stackable: Floor 15/Trolley 15)  
(Remove Tablet to Stack)

Band 1 .....	£517
Band 2 .....	£526
Band 3 .....	£539
Band 4 .....	£554
Band 5 .....	£569
Band 6 .....	£583
Band 7 .....	£598
Leather Group 1 .....	POA

# THEIA STOOL

## CONFERENCE, MEETING & CAFÉ



The Theia Stool is available in 2 different height options. A range of plastic colours and multiple finish variants are provided with or without arms.

### Plastic Colours



### Frame Colours



### Product Features



Vescom Bowen 7030.37 (Band 6) with Chrome Frame



# THEIA STOOL

## CONFERENCE, MEETING & CAFÉ



**EIH**  
High Stool  
Plastic Seat & Back  
(Stackable: Floor 20)  
£332



**EIAH**  
High Stool  
Plastic Seat and Back with Arms  
(Stackable: Floor 20)  
£385



**EIL**  
Low Stool  
Plastic Seat and Back with Arms  
(Stackable: Floor 20)  
£332



**EIAL**  
Low Stool  
Plastic Seat and Back with Arms  
(Stackable: Floor 20)  
£385



**EIHSP**  
High Stool  
Upholstered Seat  
(Stackable: Floor 15)

Band 1 .....	£388
Band 2 .....	£396
Band 3 .....	£413
Band 4 .....	£427
Band 5 .....	£442
Band 6 .....	£456
Band 7 .....	£469
Leather Group 1 .....	POA



**EIAHSP**  
High Stool  
Upholstered Seat with Arms  
(Stackable: Floor 15)

Band 1 .....	£437
Band 2 .....	£448
Band 3 .....	£464
Band 4 .....	£476
Band 5 .....	£491
Band 6 .....	£506
Band 7 .....	£519
Leather Group 1 .....	POA



**EILSP**  
Low Stool  
Upholstered Seat  
(Stackable: Floor 15)

Band 1 .....	£388
Band 2 .....	£396
Band 3 .....	£413
Band 4 .....	£427
Band 5 .....	£442
Band 6 .....	£456
Band 7 .....	£469
Leather Group 1 .....	POA



**EIALSP**  
Low Stool  
Upholstered Seat with Arms  
(Stackable: Floor 15)

Band 1 .....	£437
Band 2 .....	£448
Band 3 .....	£464
Band 4 .....	£476
Band 5 .....	£491
Band 6 .....	£506
Band 7 .....	£519
Leather Group 1 .....	POA



**EIHBP**  
High Stool  
Upholstered Seat & Back  
(Stackable: Floor 15)

Band 1 .....	£450
Band 2 .....	£461
Band 3 .....	£475
Band 4 .....	£490
Band 5 .....	£505
Band 6 .....	£518
Band 7 .....	£533
Leather Group 1 .....	POA



**EIAHBP**  
High Stool  
Upholstered Seat & Back  
with Arms  
(Stackable: Floor 15)

Band 1 .....	£492
Band 2 .....	£504
Band 3 .....	£518
Band 4 .....	£533
Band 5 .....	£546
Band 6 .....	£560
Band 7 .....	£575
Leather Group 1 .....	POA



**EILBP**  
Low Stool  
Upholstered Seat & Back  
(Stackable: Floor 15)

Band 1 .....	£450
Band 2 .....	£461
Band 3 .....	£475
Band 4 .....	£490
Band 5 .....	£505
Band 6 .....	£518
Band 7 .....	£533
Leather Group 1 .....	POA



**EIALBP**  
Low Stool  
Upholstered Seat & Back  
with Arms  
(Stackable: Floor 15)

Band 1 .....	£492
Band 2 .....	£504
Band 3 .....	£518
Band 4 .....	£533
Band 5 .....	£546
Band 6 .....	£560
Band 7 .....	£575
Leather Group 1 .....	POA

# OLI

## CONFERENCE, MEETING & CAFÉ



Oli is a stylish yet robust stacking chair which is available in seven vibrant colours.

- 3 main versions.
- Perforated back that moulds to the individual.
- Available with or without arms.

### Plastic Colours

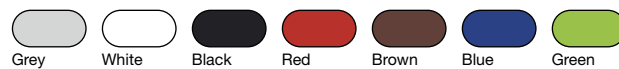

### Frame Colours



Chrome

### Product Features



### Optional Extras

OLICT Trolley

£318



Red Plastic with Camira Xtreme Sombrero YS046 (Band 1) Seat and Back





**OLI4**  
4 Leg Plastic Seat and Back (Stackable)  
£178



**OLA4**  
4 Leg with Arms and Plastic Seat and Back (Stackable)  
£231



**OLC**  
Skid Frame with Plastic Seat and Back (Stackable)  
£187



**OLS**  
4 Leg Stool with Plastic Seat and Back  
£255



**OL4SP**  
4 Leg Upholstered Seat (Stackable)

Band 1 .....	£241
Band 2 .....	£256
Band 3 .....	£273
Band 4 .....	£291
Band 5 .....	£307
Band 6 .....	£325
Band 7 .....	£342
Leather Group 1 .....	POA



**OLA4SP**  
4 Leg with Arms Upholstered Seat (Stackable)

Band 1 .....	£298
Band 2 .....	£310
Band 3 .....	£326
Band 4 .....	£345
Band 5 .....	£362
Band 6 .....	£379
Band 7 .....	£394
Leather Group 1 .....	POA



**OLCSP**  
Skid Frame with Upholstered Seat (Stackable)

Band 1 .....	£255
Band 2 .....	£265
Band 3 .....	£282
Band 4 .....	£302
Band 5 .....	£318
Band 6 .....	£336
Band 7 .....	£350
Leather Group 1 .....	POA



**OLSSP**  
4 Leg Stool with Upholstered Seat

Band 1 .....	£319
Band 2 .....	£330
Band 3 .....	£347
Band 4 .....	£368
Band 5 .....	£381
Band 6 .....	£402
Band 7 .....	£418
Leather Group 1 .....	POA



**OL4SBP**  
4 Leg with Upholstered Seat and Back (Stackable)

Band 1 .....	£285
Band 2 .....	£297
Band 3 .....	£315
Band 4 .....	£332
Band 5 .....	£347
Band 6 .....	£368
Band 7 .....	£381
Leather Group 1 .....	POA



**OLA4SBP**  
4 Leg with Arms Upholstered Seat and Back (Stackable)

Band 1 .....	£339
Band 2 .....	£348
Band 3 .....	£369
Band 4 .....	£386
Band 5 .....	£403
Band 6 .....	£420
Band 7 .....	£438
Leather Group 1 .....	POA



**OLCSBP**  
Skid Frame with Upholstered Seat and Back (Stackable)

Band 1 .....	£293
Band 2 .....	£306
Band 3 .....	£323
Band 4 .....	£342
Band 5 .....	£357
Band 6 .....	£377
Band 7 .....	£390
Leather Group 1 .....	POA



**OLSSBP**  
4 Leg Stool with Upholstered Seat and Back

Band 1 .....	£361
Band 2 .....	£372
Band 3 .....	£388
Band 4 .....	£407
Band 5 .....	£424
Band 6 .....	£442
Band 7 .....	£457
Leather Group 1 .....	POA

# SJX FULLY UPHOLSTERED CONFERENCE, MEETING & CAFÉ

5 Year  
Guarantee

SJX is the perfect seating solution for a variety of applications, with three different leg frame options.

- Four leg, cantilever and mobile on castors.
- Available with or without arms and has an optional writing tablet.
- The fully upholstered version can be finished in almost any fabric of your choice, making it a versatile product for your interiors scheme.

#### Frame Colours

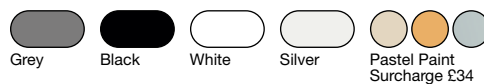

#### Product Features



#### Optional Extras

SJXLNK Retractable link set	£26
MCT Trolley (for 4 leg versions only)	£381

#### Additional Information

\*Tablet version stacking is limited.



Camira Xtreme Sombrero YS046 (Band 1) with 4 Leg Castor and Cantilever Grey Frame

5 Year Guarantee

# SJX FULLY UPHOLSTERED CONFERENCE, MEETING & CAFÉ



**SJX1**  
4 Leg (Stackable)

Band 1 .....	£236
Band 2 .....	£250
Band 3 .....	£268
Band 4 .....	£287
Band 5 .....	£303
Band 6 .....	£321
Band 7 .....	£339
Leather Group 1 .....	POA



**SJXA**  
4 Leg with Arms (Stackable)

Band 1 .....	£279
Band 2 .....	£292
Band 3 .....	£314
Band 4 .....	£330
Band 5 .....	£346
Band 6 .....	£364
Band 7 .....	£382
Leather Group 1 .....	POA



**SJXRT (R/H)  
SJXLT (L/H)**  
4 Leg with Writing Tablet and  
Arms (Stackable)\*

Band 1 .....	£385
Band 2 .....	£396
Band 3 .....	£415
Band 4 .....	£436
Band 5 .....	£450
Band 6 .....	£470
Band 7 .....	£488
Leather Group 1 .....	POA



**SJX1W**  
4 Leg with Castors

Band 1 .....	£289
Band 2 .....	£300
Band 3 .....	£320
Band 4 .....	£339
Band 5 .....	£354
Band 6 .....	£376
Band 7 .....	£390
Leather Group 1 .....	POA



**SJXAW**  
4 Leg with Castors and Arms

Band 1 .....	£334
Band 2 .....	£344
Band 3 .....	£363
Band 4 .....	£382
Band 5 .....	£401
Band 6 .....	£416
Band 7 .....	£436
Leather Group 1 .....	POA



**SJXRTW (R/H)  
SJXLTW (L/H)**  
4 Leg with Castors, Writing  
Tablet & Arms

Band 1 .....	£440
Band 2 .....	£449
Band 3 .....	£468
Band 4 .....	£488
Band 5 .....	£502
Band 6 .....	£523
Band 7 .....	£541
Leather Group 1 .....	POA



**SJX1SW**  
Swivel Base

Band 1 .....	£413
Band 2 .....	£423
Band 3 .....	£444
Band 4 .....	£464
Band 5 .....	£479
Band 6 .....	£498
Band 7 .....	£514
Leather Group 1 .....	POA

Conference,  
Meeting &  
Café Seating



**SJXC**  
Cantilever  
(Stackable)

Band 1 .....	£279
Band 2 .....	£292
Band 3 .....	£314
Band 4 .....	£330
Band 5 .....	£346
Band 6 .....	£364
Band 7 .....	£382
Leather Group 1 .....	POA



**SJXCA**  
Cantilever with Arms  
(Stackable)

Band 1 .....	£324
Band 2 .....	£338
Band 3 .....	£354
Band 4 .....	£376
Band 5 .....	£390
Band 6 .....	£408
Band 7 .....	£427
Leather Group 1 .....	POA



**SJXCRT (R/H)  
SJXCLT (L/H)**  
Cantilever Chair with Writing  
Tablet & Arms (Stackable)\*

Band 1 .....	£430
Band 2 .....	£443
Band 3 .....	£459
Band 4 .....	£479
Band 5 .....	£497
Band 6 .....	£514
Band 7 .....	£531
Leather Group 1 .....	POA



**SJXASW**  
Swivel Base with Arms

Band 1 .....	£456
Band 2 .....	£468
Band 3 .....	£488
Band 4 .....	£506
Band 5 .....	£523
Band 6 .....	£543
Band 7 .....	£560
Leather Group 1 .....	POA

# SJX UPHOLSTERED SEAT CONFERENCE, MEETING & CAFÉ

5 Year  
Guarantee

SJX is the perfect seating solution for a variety of applications, with three different leg frame options.

- Four leg, cantilever and mobile on castors.
- Available with or without arms and has an optional writing tablet.
- The upholstered seat version can be finished in almost any fabric of your choice, making it a versatile product for your interiors scheme.

## Back Plastic Colours

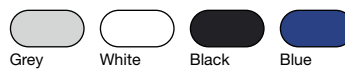

## Frame Colours



## Product Features



## Additional Information

\*Tablet version stacking is limited.

## Optional Extras

SJXLNK	Retractable link set	£26
MCT	Trolley (for 4 leg versions only)	£381



Camira Xtreme Steel YS095 (Band 1) with Black Plastic and 4 Leg White Frame

# SJX UPHOLSTERED SEAT CONFERENCE, MEETING & CAFÉ



**SJX1SP**  
4 Leg  
(Stackable)

Band 1 .....	£236
Band 2 .....	£250
Band 3 .....	£268
Band 4 .....	£287
Band 5 .....	£303
Band 6 .....	£321
Band 7 .....	£339
Leather Group 1 .....	POA



**SJXASP**  
4 Leg with Arms (Stackable)

Band 1 .....	£279
Band 2 .....	£292
Band 3 .....	£312
Band 4 .....	£330
Band 5 .....	£346
Band 6 .....	£364
Band 7 .....	£382
Leather Group 1 .....	POA



**SJXRTSP (R/H)**  
**SJXLTSP (L/H)**  
4 Leg with Writing Tablet and  
Arms (Stackable)\*

Band 1 .....	£385
Band 2 .....	£396
Band 3 .....	£415
Band 4 .....	£436
Band 5 .....	£450
Band 6 .....	£470
Band 7 .....	£488
Leather Group 1 .....	POA



**SJX1SPW**  
4 Leg with Castors

Band 1 .....	£289
Band 2 .....	£300
Band 3 .....	£320
Band 4 .....	£339
Band 5 .....	£354
Band 6 .....	£376
Band 7 .....	£390
Leather Group 1 .....	POA



**SJXASPW**  
4 Leg with Castors and Arms

Band 1 .....	£334
Band 2 .....	£344
Band 3 .....	£363
Band 4 .....	£382
Band 5 .....	£401
Band 6 .....	£416
Band 7 .....	£436
Leather Group 1 .....	POA



**SJXRTSPW (R/H)**  
**SJXLTSPW (L/H)**  
4 Leg with Castors, Writing  
Tablet and Arms

Band 1 .....	£440
Band 2 .....	£449
Band 3 .....	£468
Band 4 .....	£488
Band 5 .....	£502
Band 6 .....	£523
Band 7 .....	£541
Leather Group 1 .....	POA



**SJX1SPSW**  
Swivel Base

Band 1 .....	£413
Band 2 .....	£423
Band 3 .....	£444
Band 4 .....	£464
Band 5 .....	£479
Band 6 .....	£498
Band 7 .....	£514
Leather Group 1 .....	POA



**SJXCSP**  
Cantilever  
(Stackable)

Band 1 .....	£279
Band 2 .....	£292
Band 3 .....	£314
Band 4 .....	£330
Band 5 .....	£346
Band 6 .....	£364
Band 7 .....	£382
Leather Group 1 .....	POA



**SJXCASP**  
Cantilever with Arms  
(Stackable)

Band 1 .....	£324
Band 2 .....	£338
Band 3 .....	£354
Band 4 .....	£376
Band 5 .....	£390
Band 6 .....	£408
Band 7 .....	£427
Leather Group 1 .....	POA



**SJXCRTSP (R/H)**  
**SJXCLTSP (L/H)**  
Cantilever with Writing Tablet  
& Arms (Stackable)\*

Band 1 .....	£430
Band 2 .....	£443
Band 3 .....	£459
Band 4 .....	£479
Band 5 .....	£497
Band 6 .....	£514
Band 7 .....	£531
Leather Group 1 .....	POA



**SJXASPSW**  
Swivel Base with Arms

Band 1 .....	£456
Band 2 .....	£468
Band 3 .....	£488
Band 4 .....	£506
Band 5 .....	£523
Band 6 .....	£543
Band 7 .....	£560
Leather Group 1 .....	POA

# SJX MESH

## CONFERENCE, MEETING & CAFÉ

5 Year Guarantee

SJX is the perfect seating solution for a variety of applications, with three different leg frame options.

- Four leg, cantilever and mobile on castors.
- Available with or without arms and has an optional writing tablet.

### Frame Colours

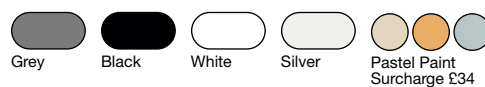

### Product Features



### Additional Information

\*Tablet version stacking is limited.

### Optional Extras

SJXLNK	Retractable link set	£26
MCT	Trolley (for 4 leg versions only)	£381



Camira Blazer Knightsbridge CUZ26 (Band 4) with 4 Leg Black Frame



**SJXM1**  
4 Leg Upholstered Seat  
(Stackable)

Band 1 .....	£236
Band 2 .....	£250
Band 3 .....	£268
Band 4 .....	£287
Band 5 .....	£303
Band 6 .....	£321
Band 7 .....	£339
Leather Group 1 .....	POA



**SJXMA**  
4 Leg Upholstered Seat with  
Arms (Stackable)

Band 1 .....	£279
Band 2 .....	£292
Band 3 .....	£314
Band 4 .....	£330
Band 5 .....	£346
Band 6 .....	£364
Band 7 .....	£382
Leather Group 1 .....	POA



**SJXMRT (R/H)**  
**SJXMLT (L/H)**  
4 Leg Upholstered Seat with  
Writing Tablet and Arms  
(Stackable)\*

Band 1 .....	£385
Band 2 .....	£396
Band 3 .....	£415
Band 4 .....	£436
Band 5 .....	£450
Band 6 .....	£470
Band 7 .....	£488
Leather Group 1 .....	POA



**SJXM1W**  
4 Leg Upholstered Seat with  
Castors

Band 1 .....	£289
Band 2 .....	£300
Band 3 .....	£320
Band 4 .....	£339
Band 5 .....	£354
Band 6 .....	£376
Band 7 .....	£390
Leather Group 1 .....	POA



**SJXMAW**  
4 Leg Upholstered Seat with  
Castors and Arms

Band 1 .....	£334
Band 2 .....	£344
Band 3 .....	£363
Band 4 .....	£382
Band 5 .....	£401
Band 6 .....	£416
Band 7 .....	£436
Leather Group 1 .....	POA



**SJXMRTW (R/H)**  
**SJXMLTW (L/H)**  
4 Leg Upholstered Seat with  
Writing Tablet - Castors and  
Arms

Band 1 .....	£440
Band 2 .....	£449
Band 3 .....	£467
Band 4 .....	£488
Band 5 .....	£502
Band 6 .....	£523
Band 7 .....	£541
Leather Group 1 .....	POA



**SJXM1SW**  
Swivel Base

Band 1 .....	£413
Band 2 .....	£423
Band 3 .....	£444
Band 4 .....	£460
Band 5 .....	£479
Band 6 .....	£498
Band 7 .....	£514
Leather Group 1 .....	POA



**SJXMC**  
Cantilever Upholstered Seat  
(Stackable)

Band 1 .....	£279
Band 2 .....	£292
Band 3 .....	£314
Band 4 .....	£330
Band 5 .....	£346
Band 6 .....	£364
Band 7 .....	£382
Leather Group 1 .....	POA



**SJXMCA**  
Cantilever Upholstered Seat  
with Arms (Stackable)

Band 1 .....	£324
Band 2 .....	£338
Band 3 .....	£354
Band 4 .....	£376
Band 5 .....	£390
Band 6 .....	£408
Band 7 .....	£427
Leather Group 1 .....	POA



**SJXMCRT (R/H)**  
**SJXMCALT (L/H)**  
Cantilever Upholstered Seat  
with Writing Tablet and Arms  
(Stackable)\*

Band 1 .....	£430
Band 2 .....	£443
Band 3 .....	£459
Band 4 .....	£479
Band 5 .....	£497
Band 6 .....	£514
Band 7 .....	£531
Leather Group 1 .....	POA



**SJXMASW**  
Swivel Base with Arms

Band 1 .....	£456
Band 2 .....	£468
Band 3 .....	£488
Band 4 .....	£506
Band 5 .....	£523
Band 6 .....	£543
Band 7 .....	£560
Leather Group 1 .....	POA

# SJX PLASTIC

## CONFERENCE, MEETING & CAFÉ

5 Year Guarantee

SJX is the perfect seating solution for a variety of applications, with three different leg frame options.

- Four leg, cantilever and mobile on castors.
- Available with or without arms and has an optional writing tablet.

### Plastic Colours



### Frame Colours



### Product Features



### Additional Information

\*Tablet version stacking is limited.

### Optional Extras

SJXLNK Retractable link set	£26
MCT Trolley (for 4 leg versions only)	£381



SJXP1  
4 Leg (Stackable)  
£202



SJXPA  
4 Leg with Arms  
(Stackable)  
£243



SJXPRT (R/H)  
SJXPLT (L/H)  
4 Leg with Writing Tablet & Arms  
(Stackable)\*  
£334



SJXP1W  
4 Leg with Castors  
£256



SJXPAW  
4 Leg with Castors and Arms  
£298



SJXPRTW (R/H)  
SJXPLTW (L/H)  
4 Leg Chair with Castors  
Writing Tablet & Arms  
£385



SJXP1SW  
Swivel Base  
£405



SJXCP1  
Cantilever  
(Stackable)  
£273



SJXCPA  
Cantilever with Arms  
(Stackable)  
£317



SJXCPRT (R/H)  
SJXCPLT (L/H)  
Cantilever with Writing Tablet &  
Arms (Stackable)\*  
£406



SJXPASW  
Swivel Base with Arms  
£448



5 Year  
Guarantee

## SJX PLASTIC CONFERENCE, MEETING & CAFÉ



White Plastic with White Cantilever Frame

Conference,  
Meeting &  
Café Seating

# ZELA FULLY UPHOLSTERED CONFERENCE, MEETING & CAFÉ



### Plastic Colours

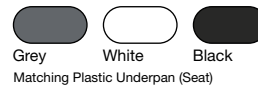

Matching Plastic Underpan (Seat)

### Frame Colours



### Product Features



### Additional Information

Swivel Versions - Available with chrome frame only.  
\*Tablet version stacking is limited.

### Optional Extras

Polished aluminum arm £50 surcharge  
ZTROL Trolley (for 4 leg versions only)  
Will stack up to 18 high

£589



Stacking aid

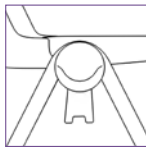

Dual link and stacking feature

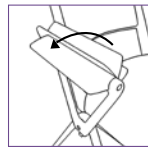

Width adjustable arm



Kvadrat Canvas 2 0954 (Band 4) with White Plastic and White Frame

5 Year  
Guarantee

# ZELA FULLY UPHOLSTERED CONFERENCE, MEETING & CAFÉ



**ZL1BP**  
4 Leg (Stackable)

Band 1 .....	£163
Band 2 .....	£170
Band 3 .....	£187
Band 4 .....	£203
Band 5 .....	£219
Band 6 .....	£232
Band 7 .....	£250
Leather Group 1 .....	POA



**ZLABP**  
4 Leg with Black Plastic Arms  
(Stackable)

Band 1 .....	£203
Band 2 .....	£213
Band 3 .....	£230
Band 4 .....	£243
Band 5 .....	£261
Band 6 .....	£275
Band 7 .....	£291
Leather Group 1 .....	POA



**ZLARTBP (RH)  
ZLALTBP (LH)**  
4 Leg with Black Aluminium Arms and  
Writing Tablet (Stackable)\*

Band 1 .....	£321
Band 2 .....	£332
Band 3 .....	£348
Band 4 .....	£363
Band 5 .....	£380
Band 6 .....	£392
Band 7 .....	£408
Leather Group 1 .....	POA



**ZL1BPSW**  
Swivel Base

Band 1 .....	£354
Band 2 .....	£364
Band 3 .....	£382
Band 4 .....	£396
Band 5 .....	£413
Band 6 .....	£428
Band 7 .....	£444
Leather Group 1 .....	POA



**ZLABPSW**  
Swivel Base with Black Plastic Arms

Band 1 .....	£396
Band 2 .....	£407
Band 3 .....	£426
Band 4 .....	£442
Band 5 .....	£455
Band 6 .....	£470
Band 7 .....	£487
Leather Group 1 .....	POA



Conference,  
Meeting &  
Café Seating

# ZELA UPHOLSTERED SEAT

## CONFERENCE, MEETING & CAFÉ



Zela multi-purpose seating lends itself perfectly to large scale conferencing, meeting rooms and single use application.

- Unique design
- Robust structure and elegant lines will complement any environment.
- Available in eight plastic colours (Backs).
- Dual linking/vertical stacking feature.

### Back Plastic Colours



Black Plastic Underpan (Seat)



Matching Plastic Underpan (Seat)

### Frame Colours



### Product Features



### Additional Information

Swivel Versions - Available with chrome frame only.  
\*Tablet version stacking is limited.

### Optional Extras

Polished aluminum arm £50 surcharge  
ZTROL Trolley (for 4 leg versions only)  
Will stack up to 18 high

£589



Stacking aid

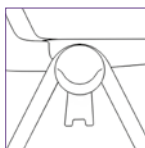

Dual link and stacking feature

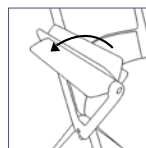

Width adjustable arm



Grey Plastic with White Frame and Gabriel Fame 66133 (Band 4) Seat

5 Year Guarantee

# ZELA UPHOLSTERED SEAT CONFERENCE, MEETING & CAFÉ



**ZL1SP**  
4 Leg (Stackable)

Band 1 .....	£134
Band 2 .....	£147
Band 3 .....	£164
Band 4 .....	£177
Band 5 .....	£194
Band 6 .....	£210
Band 7 .....	£224
Leather Group 1 .....	POA



**ZLASP**  
4 Leg with Black Plastic Arms  
(Stackable)

Band 1 .....	£177
Band 2 .....	£187
Band 3 .....	£206
Band 4 .....	£222
Band 5 .....	£234
Band 6 .....	£253
Band 7 .....	£267
Leather Group 1 .....	POA



**ZLARTSP (RH)  
ZLALTSP (LH)**  
4 Leg with Black Aluminium Arms and  
Writing Tablet (Stackable)\*

Band 1 .....	£294
Band 2 .....	£306
Band 3 .....	£323
Band 4 .....	£339
Band 5 .....	£352
Band 6 .....	£371
Band 7 .....	£408
Leather Group 1 .....	POA



**ZL1SPSW**  
Swivel Base

Band 1 .....	£330
Band 2 .....	£340
Band 3 .....	£357
Band 4 .....	£374
Band 5 .....	£387
Band 6 .....	£404
Band 7 .....	£416
Leather Group 1 .....	POA



**ZLASPSW**  
Swivel Base with Black Plastic Arms

Band 1 .....	£374
Band 2 .....	£382
Band 3 .....	£401
Band 4 .....	£414
Band 5 .....	£430
Band 6 .....	£445
Band 7 .....	£459
Leather Group 1 .....	POA



**ZTROL**

# ZELA MESH

## CONFERENCE, MEETING & CAFÉ



Zela multi-purpose seating lends itself perfectly to large scale conferencing, meeting rooms and single use application.

- Unique design.
- Robust structure and elegant lines will complement any environment.
- Available in three plastic shell colours.
- Dual linking/vertical stacking feature.

### Plastic Colours



### Frame Colours



### Product Features



### Optional Extras

Polished aluminum arm £50 surcharge  
 ZTROL Trolley (for 4 leg versions only) £589  
 Will stack up to 18 high



Stacking aid

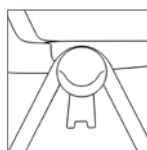

Dual link and stacking feature

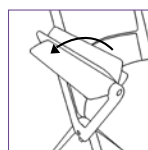

Width adjustable arm



ZLM  
4 Leg

Price .....£163



ZLMA  
4 Leg with Black Plastic Arms

Price .....£203



ZLMU  
4 Leg with Upholstered Seat

Band 1 .....£188  
 Band 2 .....£202  
 Band 3 .....£214  
 Band 4 .....£230  
 Band 5 .....£243  
 Band 6 .....£257  
 Band 7 .....£272  
 Leather Group 1 ..... POA



ZLMAU  
4 Leg with Upholstered Seat with Black Plastic Arms

Band 1 .....£230  
 Band 2 .....£243  
 Band 3 .....£257  
 Band 4 .....£272  
 Band 5 .....£286  
 Band 6 .....£300  
 Band 7 .....£314  
 Leather Group 1 ..... POA

5 Year  
Guarantee

## ZELA MESH CONFERENCE, MEETING & CAFÉ



Black Plastic and Black Frame with Bute Alchemy Mimosa CF1012/1711 (Band 6) Seat

Conference,  
Meeting &  
Café Seating

# ZELA PLASTIC

## CONFERENCE, MEETING & CAFÉ



Zela multi-purpose seating lends itself perfectly to large scale conferencing, meeting rooms and single use application.

- Unique design.
- Robust structure and elegant lines will complement any environment.
- Available in eight plastic colours.
- Dual linking/vertical stacking feature.

### Plastic Colours



### Product Features



### Additional Information

Swivel Versions - Available with chrome frame only.  
\*Tablet version stacking is limited.

### Optional Extras

Polished aluminum arm £50 surcharge  
ZTROL Trolley (for 4 leg versions only)  
Will stack up to 18 high

£589



Stacking aid

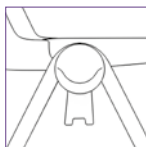

Dual link and stacking feature

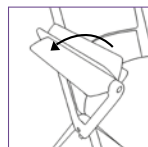

Width adjustable arm



ZL1  
4 Leg (Stackable)  
£109



ZLA  
4 Leg with Black Plastic Arms  
(Stackable)  
£153



ZLART (RH)  
ZLALT (LH)  
4 Leg with Black Aluminium Arms and  
Writing Tablet (Stackable)\*  
£272



ZL1SW  
Swivel Base  
£304



ZLASW  
Swivel Base with Black Plastic Arms  
£346



5 Year  
Guarantee

# ZELA PLASTIC CONFERENCE, MEETING & CAFÉ



Black Plastic with Grey Frame

Conference,  
Meeting &  
Café Seating

# MEETING CHAIR

## CONFERENCE, MEETING & CAFÉ



This meeting chair collection is ideal for all your conference and meeting requirements.

- Available fully upholstered, upholstered seat or all plastic.
- Each version comes with or without arms.
- Incorporated linking bracket as standard.

### Plastic Colours



Black

### Frame Colour



Silver

### Product Features



Linking included

### Optional Extras

MTM Mobile trolley (Black only) Stacks 25 (Max)

£381



Camira Xtreme Parasol YS073 (Band 1) Back and Camira Xtreme Ocean YS100 (Band 1) Seat

5 Year  
Guarantee

# MEETING CHAIR

## CONFERENCE, MEETING & CAFÉ



**M1**  
Plastic Seat and Back  
(Stackable)  
£148



**MA**  
Plastic Seat and Back  
with Arms (Stackable)  
£188



**MW**  
Plastic Seat and Back  
with Writing Tablet  
£277



**M1SP**  
Upholstered Seat  
(Stackable)

Band 1 .....	£214
Band 2 .....	£228
Band 3 .....	£243
Band 4 .....	£264
Band 5 .....	£279
Band 6 .....	£299
Band 7 .....	£317
Leather Group 1 .....	POA



**MASP**  
Upholstered Seat  
with Arms (Stackable)

Band 1 .....	£257
Band 2 .....	£268
Band 3 .....	£287
Band 4 .....	£304
Band 5 .....	£321
Band 6 .....	£340
Band 7 .....	£357
Leather Group 1 .....	POA



**MWSP**  
Upholstered Seat  
with Writing Tablet

Band 1 .....	£343
Band 2 .....	£354
Band 3 .....	£376
Band 4 .....	£391
Band 5 .....	£408
Band 6 .....	£428
Band 7 .....	£445
Leather Group 1 .....	POA



**M1SBP**  
Upholstered Seat  
and Back (Stackable)

Band 1 .....	£258
Band 2 .....	£270
Band 3 .....	£288
Band 4 .....	£306
Band 5 .....	£323
Band 6 .....	£342
Band 7 .....	£358
Leather Group 1 .....	POA



**MASBP**  
Upholstered Seat and Back  
with Arms (Stackable)

Band 1 .....	£300
Band 2 .....	£315
Band 3 .....	£332
Band 4 .....	£349
Band 5 .....	£370
Band 6 .....	£385
Band 7 .....	£404
Leather Group 1 .....	POA



**MWSBP**  
Upholstered Seat  
and Back with Writing Tablet

Band 1 .....	£388
Band 2 .....	£403
Band 3 .....	£420
Band 4 .....	£440
Band 5 .....	£455
Band 6 .....	£472
Band 7 .....	£491
Leather Group 1 .....	POA

Conference,  
Meeting &  
Café Seating

# METRIC PLUS

## CONFERENCE, MEETING & CAFÉ



Metric Plus is a family of products including swivel, four leg and cantilever chairs.

- Perfect for use throughout the office environment.
- Offered in a selection of back styles and sizes.
- Range includes fabric, plastic and mesh back options.

Plastic Colours (Available on MCHBPL and M4HBPL only)



Black

Product Features



Frame Colours

Swivel Versions - Black Polypropylene base as standard.  
Cantilever / 4 Leg options - Available in chrome frames only

Optional Extras

Polished aluminium five star base	£61
MCT Trolley (for 4 leg versions only)	£370



**MSFB**

Full Back Swivel Base with Upholstered Seat and Back

Band 1 .....	£463
Band 2 .....	£478
Band 3 .....	£506
Band 4 .....	£530
Band 5 .....	£556
Band 6 .....	£580
Band 7 .....	£605
Leather Group 1 .....	£805



**MSHB**

Half Back Swivel Base with Upholstered Seat and Back

Band 1 .....	£444
Band 2 .....	£459
Band 3 .....	£487
Band 4 .....	£514
Band 5 .....	£540
Band 6 .....	£562
Band 7 .....	£588
Leather Group 1 .....	£783



**MSHBM**

Swivel Base with Mesh Back and Upholstered Seat

Band 1 .....	£444
Band 2 .....	£459
Band 3 .....	£487
Band 4 .....	£514
Band 5 .....	£540
Band 6 .....	£562
Band 7 .....	£588
Leather Group 1 .....	£783



**M4HBM**

4 Leg Half Mesh Back and Upholstered Seat (Stackable)

Band 1 .....	£340
Band 2 .....	£353
Band 3 .....	£384
Band 4 .....	£409
Band 5 .....	£434
Band 6 .....	£458
Band 7 .....	£483
Leather Group 1 .....	£548



**MCHBM**

Cantilever Half Mesh Back and Upholstered Seat (Stackable)

Band 1 .....	£370
Band 2 .....	£384
Band 3 .....	£414
Band 4 .....	£437
Band 5 .....	£462
Band 6 .....	£486
Band 7 .....	£513
Leather Group 1 .....	£578



**MCHBPL**

Cantilever with Plastic Seat and Back (Stackable)

£271



**M4HBPL**

4 Leg with Plastic Seat and Back (Stackable)

£255

Conference, Meeting & Cafe Seating

5 Year  
Guarantee

# METRIC PLUS

CONFERENCE, MEETING & CAFÉ



Conference,  
Meeting &  
Café Seating

From L/R 4 Leg and Cantilever with Gabriel Europost 2 68126 (Band 3) Seat

# METRIC PLUS EXECUTIVE CONFERENCE, MEETING & CAFÉ

5 Year  
Guarantee

Metric Plus Executive is the perfect mix of comfort and elegance.

- Available in both cantilever and 4 leg options.
- Extension of the standard Metric Plus range.
- Fits any office or managerial environment.

## Product Features



## Frame Colours



Chrome

## Optional Extras

MCT Trolley (for 4 leg versions only) £370



**MCFB**  
Full Back Cantilever  
(Stackable)

Band 1 .....	£419
Band 2 .....	£434
Band 3 .....	£462
Band 4 .....	£486
Band 5 .....	£513
Band 6 .....	£537
Band 7 .....	£561
Leather Group 1 .....	£757



**MCHB**  
Half Back Cantilever  
(Stackable)

Band 1 .....	£370
Band 2 .....	£384
Band 3 .....	£414
Band 4 .....	£437
Band 5 .....	£462
Band 6 .....	£486
Band 7 .....	£513
Leather Group 1 .....	£708



**M4FB**  
Full Back 4 Leg  
(Stackable)

Band 1 .....	£362
Band 2 .....	£374
Band 3 .....	£402
Band 4 .....	£429
Band 5 .....	£452
Band 6 .....	£477
Band 7 .....	£501
Leather Group 1 .....	£702



**M4HB**  
Half Back 4 Leg  
(Stackable)

Band 1 .....	£340
Band 2 .....	£359
Band 3 .....	£384
Band 4 .....	£409
Band 5 .....	£434
Band 6 .....	£458
Band 7 .....	£483
Leather Group 1 .....	£680



Panaz Harvard Cream 805 (Band 3)

Kempton is a stylish conference chair collection. Its carefully considered design comes as standard with or without arms.

- Optional linking bracket.
- Writing tablet versions (RH/LH).
- Perfect for large scale conference or education environments.

### Product Features



### Frame Colours



### Optional Extras

KNLNK Optional Link Bracket £26



**K1**  
4 Leg (Stackable)

Band 1 .....	£182
Band 2 .....	£194
Band 3 .....	£211
Band 4 .....	£227
Band 5 .....	£239
Band 6 .....	£257
Band 7 .....	£272
Leather Group 1 .....	POA



**KA**  
4 Leg With Arms  
(Stackable Spirally)

Band 1 .....	£255
Band 2 .....	£262
Band 3 .....	£278
Band 4 .....	£293
Band 5 .....	£312
Band 6 .....	£325
Band 7 .....	£341
Leather Group 1 .....	POA



**KWMA**  
4 Leg With R/H Moulded Writing  
Tablet & Arms

Band 1 .....	£320
Band 2 .....	£330
Band 3 .....	£346
Band 4 .....	£362
Band 5 .....	£378
Band 6 .....	£390
Band 7 .....	£407
Leather Group 1 .....	POA



**MCT**  
Trolley - Black  
£379



Camira Blazer Knightsbridge CUZ26 (Band 4)

# MOD

## CONFERENCE, MEETING & CAFÉ



Mod is a fantastic meeting and conference chair, also perfect for classrooms. It's distinctive arms and well cushioned seat provides both style and comfort for prolonged periods of sitting.

- Available with or without arms.
- Non-linking.

### Product Features



### Frame Colours



**MOD1**  
Conference Chair Black Frame

Band 1 .....	£141
Band 2 .....	£151
Band 3 .....	£167
Band 4 .....	£181
Band 5 .....	£198
Band 6 .....	£213
Band 7 .....	£229
Leather Group 1 .....	POA



**MODA**  
Conference Chair with Arms  
Black Frame

Band 1 .....	£183
Band 2 .....	£195
Band 3 .....	£212
Band 4 .....	£228
Band 5 .....	£236
Band 6 .....	£258
Band 7 .....	£273
Leather Group 1 .....	POA



Mod Chair with Arms



5 Year  
Guarantee

NEW  
PRODUCT

# MOD CONFERENCE, MEETING & CAFÉ



Conference,  
Meeting &  
Café Seating

Mod Chairs with and without Arms

# HEAVY DUTY CONFERENCE, MEETING & CAFÉ



This selection of fully welded frame seating is ideal for heavy use areas such as education and emergency service environments.

- Accompanied with a generous and comfortable seat pad.
- Can also be used in conference style auditoriums.

#### Frame Colours

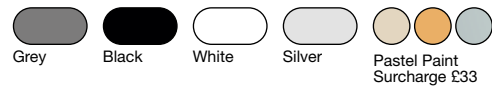

#### Product Features



#### Additional Information

\* 110SWT Stackable with Tablet removed.

#### Optional Extras

CLF	Linking for 110C	£16
MCT	Trolley (for 4 leg versions only)	£379
MFFB	Floor fixing bracket (set of 4)	£114



Camira Xtreme Scuba YS082 (Band 1) with Grey Frame

Conference, Meeting & Café Seating

# HEAVY DUTY CONFERENCE, MEETING & CAFÉ



**110C**  
4 Leg Heavy Duty with Curved Front Legs (Stackable)

Band 1	£180
Band 2	£194
Band 3	£219
Band 4	£242
Band 5	£261
Band 6	£286
Band 7	£306
Leather Group 1	POA



**120SM**  
4 Leg Heavy Duty with Moulded Arms (Stackable)

Band 1	£225
Band 2	£240
Band 3	£261
Band 4	£286
Band 5	£306
Band 6	£329
Band 7	£352
Leather Group 1	POA



**110SWT**  
4 Leg Heavy Duty with Swivel Writing Tablet (Fits Either Side) (Stackable)\*

Band 1	£295
Band 2	£308
Band 3	£333
Band 4	£355
Band 5	£378
Band 6	£398
Band 7	£421
Leather Group 1	POA



**LOS1**  
4 Leg Heavy Duty (Stackable)

Band 1	£180
Band 2	£195
Band 3	£230
Band 4	£255
Band 5	£284
Band 6	£309
Band 7	£338
Leather Group 1	POA



**230**  
Cantilever Heavy Duty with 3/4 Back

Band 1	£236
Band 2	£254
Band 3	£286
Band 4	£314
Band 5	£343
Band 6	£370
Band 7	£396
Leather Group 1	POA



**240M**  
Cantilever Heavy Duty with 3/4 Back and Arms

Band 1	£299
Band 2	£316
Band 3	£347
Band 4	£376
Band 5	£404
Band 6	£428
Band 7	£455
Leather Group 1	POA



**210S**  
4 Leg Heavy Duty (Stackable)

Band 1	£204
Band 2	£220
Band 3	£253
Band 4	£282
Band 5	£306
Band 6	£334
Band 7	£363
Leather Group 1	POA



**220M**  
4 Leg Heavy Duty with Moulded Arms

Band 1	£255
Band 2	£273
Band 3	£304
Band 4	£332
Band 5	£358
Band 6	£385
Band 7	£416
Leather Group 1	POA



**310S**  
4 Leg Heavy Duty with Mid Back (Stackable)

Band 1	£302
Band 2	£332
Band 3	£382
Band 4	£429
Band 5	£482
Band 6	£527
Band 7	£575
Leather Group 1	POA



**340M**  
Cantilever Heavy Duty with Moulded Arms

Band 1	£346
Band 2	£376
Band 3	£427
Band 4	£475
Band 5	£521
Band 6	£568
Band 7	£617
Leather Group 1	POA



**320M**  
4 Leg Heavy Duty with Moulded Arms

Band 1	£372
Band 2	£404
Band 3	£454
Band 4	£501
Band 5	£549
Band 6	£597
Band 7	£643
Leather Group 1	POA



**330**  
Cantilever Heavy Duty

Band 1	£287
Band 2	£317
Band 3	£371
Band 4	£417
Band 5	£466
Band 6	£512
Band 7	£558
Leather Group 1	POA



**430**  
High Back Cantilever

Band 1	£421
Band 2	£451
Band 3	£504
Band 4	£550
Band 5	£601
Band 6	£649
Band 7	£697
Leather Group 1	POA



**420M**  
High Back 4 Leg with Moulded Arms

Band 1	£512
Band 2	£542
Band 3	£595
Band 4	£638
Band 5	£690
Band 6	£735
Band 7	£783
Leather Group 1	POA



**440M**  
High Back Cantilever

Band 1	£496
Band 2	£527
Band 3	£580
Band 4	£626
Band 5	£674
Band 6	£723
Band 7	£767
Leather Group 1	POA



**410S**  
High Back 4 Leg Stacking

Band 1	£444
Band 2	£472
Band 3	£527
Band 4	£573
Band 5	£619
Band 6	£667
Band 7	£717
Leather Group 1	POA



**120MWT**  
3/4 Back with Moulded Arms and Writing Tablet

Band 1	£326
Band 2	£343
Band 3	£366
Band 4	£385
Band 5	£413
Band 6	£429
Band 7	£452
Leather Group 1	POA



**BAR2**  
Bariatric Medium Part Back Steel Frame

Band 1	£427
Band 2	£451
Band 3	£496
Band 4	£537
Band 5	£575
Band 6	£613
Band 7	£653
Leather Group 1	POA



**BAR3**  
Bariatric Medium Full Back Steel Frame

Band 1	£633
Band 2	£659
Band 3	£701
Band 4	£738
Band 5	£779
Band 6	£819
Band 7	£860
Leather Group 1	POA

# TURN CONFERENCE, MEETING & CAFÉ



- All versions stackable.
- Mesh back options - Available in Black, Grey, Red or White.

### Product Features



### Frame Colours

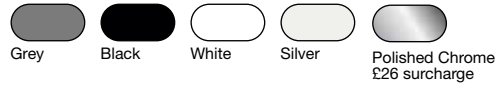

<p><b>TUR1</b> Chair Plastic Seat and Back</p> <p>Band 1 .....£182</p>	<p><b>TUR1SP</b> Chair Upholstered Seat with Plastic Back</p> <p>Band 1 .....£209 Band 2 .....£212 Band 3 .....£223 Band 4 .....£230 Band 5 .....£238 Band 6 .....£252 Band 7 .....£258</p>	<p><b>TUR1SBP</b> Chair Upholstered Seat and Back</p> <p>Band 1 .....£238 Band 2 .....£241 Band 3 .....£256 Band 4 .....£262 Band 5 .....£273 Band 6 .....£281 Band 7 .....£289</p>	<p><b>TURM1</b> Chair Mesh Back with Plastic Seat</p> <p>Band 1 .....£332</p>	<p><b>TURM1SP</b> Chair Mesh Back with Upholstered Seat</p> <p>Band 1 .....£357 Band 2 .....£363 Band 3 .....£376 Band 4 .....£381 Band 5 .....£390 Band 6 .....£402 Band 7 .....£409</p>
<p><b>TURA</b> Chair with Arms Plastic Seat and Back</p> <p>Band 1 .....£231</p>	<p><b>TURASP</b> Chair with Arms Upholstered Seat with Plastic Back</p> <p>Band 1 .....£257 Band 2 .....£261 Band 3 .....£272 Band 4 .....£278 Band 5 .....£289 Band 6 .....£298 Band 7 .....£306</p>	<p><b>TURASBP</b> Chair with Arms Upholstered Seat and Back</p> <p>Band 1 .....£287 Band 2 .....£292 Band 3 .....£303 Band 4 .....£314 Band 5 .....£322 Band 6 .....£330 Band 7 .....£339</p>	<p><b>TURMA</b> Chair with Arms Mesh Back with Plastic Seat</p> <p>Band 1 .....£380</p>	<p><b>TURMASP</b> Chair with Arms Mesh Back with Upholstered Seat</p> <p>Band 1 .....£407 Band 2 .....£412 Band 3 .....£424 Band 4 .....£432 Band 5 .....£442 Band 6 .....£448 Band 7 .....£457</p>



# TURN MOBILE CONFERENCE, MEETING & CAFÉ

- All versions stackable.
- Mesh back options - Available in Black, Grey, Red or White.

## Product Features



### Frame Colours

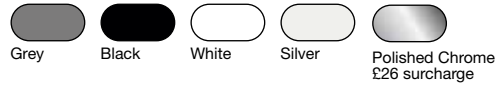

TUR1W Mobile Chair Plastic Seat and Back	
Band 1	£235

TUR1SPW Mobile Chair Upholstered Seat with Plastic Back	
Band 1	£250
Band 2	£265
Band 3	£274
Band 4	£282
Band 5	£292
Band 6	£302
Band 7	£312

TUR1SBPW Mobile Chair Upholstered Seat and Back	
Band 1	£291
Band 2	£297
Band 3	£306
Band 4	£316
Band 5	£325
Band 6	£335
Band 7	£342

TURM1W Mobile Chair Mesh Back with Plastic Seat	
Band 1	£384

TURM1SPW Mobile Chair Mesh Back with Upholstered Seat	
Band 1	£411
Band 2	£414
Band 3	£426
Band 4	£436
Band 5	£444
Band 6	£452
Band 7	£462

TURAW Mobile Chair with Arms Plastic Seat and Back	
Band 1	£285

TURASPW Mobile Chair with Arms Upholstered Seat with Plastic Back	
Band 1	£312
Band 2	£316
Band 3	£325
Band 4	£335
Band 5	£343
Band 6	£350
Band 7	£361

TURASBPW Mobile Chair with Arms Upholstered Seat and Back	
Band 1	£338
Band 2	£342
Band 3	£350
Band 4	£362
Band 5	£372
Band 6	£379
Band 7	£387

TURMAW Mobile Chair with Arms Mesh Back with Plastic Seat	
Band 1	£434

TURMASPW Mobile Chair with Arms Mesh Back with Upholstered Seat	
Band 1	£458
Band 2	£465
Band 3	£474
Band 4	£485
Band 5	£494
Band 6	£500
Band 7	£510



# INTRODUCTION

## SOFT SEATING, RECEPTION & BREAKOUT

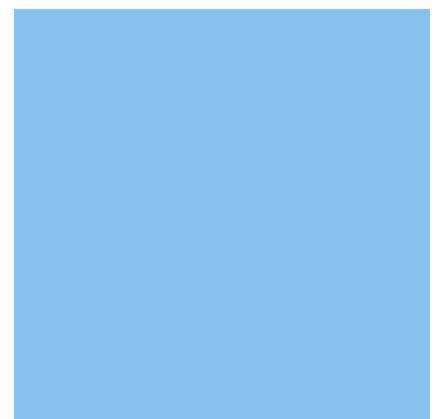
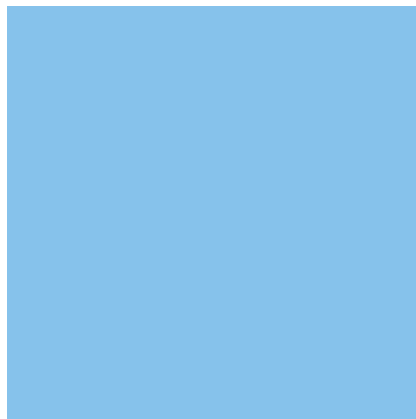
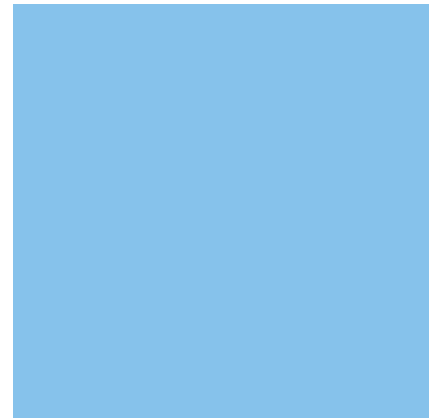
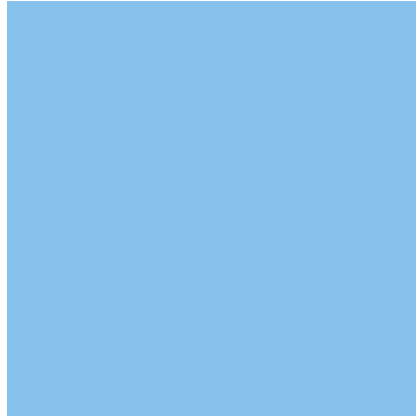

Reception,  
Breakout &  
Soft Seating

# KEY SOFT SEATING, RECEPTION & BREAKOUT



Selected items within this range are stackable. These items are identified within the product description.

For further information regarding stacking quantity - Please contact our Sales Department.



Items are available in a variety of fabrics. A number of products possess certain upholstery restrictions - these are therefore available in selected fabrics only and are identified within this brochure.

For further information regarding fabric suitability - Please contact our Sales Department.



Arms are available on designated product ranges as indicated within the relevant product thumbnails. Colour / Finish options are indicated on relevant product pages - where applicable.

For further information regarding Arm options - Please contact our Sales Department.



Feet are available on designated product ranges as indicated within the relevant product thumbnails. Colour / Finish options are indicated on relevant product pages - where applicable.

For further information regarding Feet options - Please contact our Sales Department.



Items include Reflex Foam Structure as standard.

Level 'S' tested to BS5459: Part 2: 2000.

Extreme Comfort.

Consistent Shape Retention.

Durability and long life.

Excellent Fire Retardant Properties.

---

We recommend that you request fabric samples prior to ordering.

Two tone upholstery is available on selected products. Please contact our Sales Department for further information.

You can find dimensions for all products in the technical data section of this brochure.

Please Note: All images shown are for illustrative purposes.

Some aspects of certain products may differ. Please contact our customer services department with any queries.

# MONOKO

## SOFT SEATING, RECEPTION & BREAKOUT

5 Year Guarantee

### Monoko: For contemplation or collaboration

Designed with the needs of the modern mixed-use space in mind, our Monoko collection of single and dual chairs is stylish and comfortable in equal measure.

Available as either a single, or double seater, with frame in a natural or dark wood finish, plus bespoke choice of fabrics – from on-trend seventies' inspired mustard to pared back charcoal grey – Monoko's chic, Scandinavian style offers comfort to those seeking anything from contemplative quiet to a collaborative chat, whether in a workplace, home, or hospitality environment.

### Wooden Base Colours



### Product Features



**MON1S**  
Single Seater  
Arm Chair



**MON2S**  
Two Seater  
Arm Chair

Band 1 .....	£2,257
Band 2 .....	£2,303
Band 3 .....	£2,356
Band 4 .....	£2,421
Band 5 .....	£2,477
Band 6 .....	£2,550
Band 7 .....	£2,623

Band 1 .....	£2,853
Band 2 .....	£2,945
Band 3 .....	£3,051
Band 4 .....	£3,181
Band 5 .....	£3,292
Band 6 .....	£3,438
Band 7 .....	£3,584



Fabric: Kvadrat Melange Nap 461 and Kvadrat Fiord 201



5 Year  
Guarantee

# MONOKO

SOFT SEATING, RECEPTION & BREAKOUT

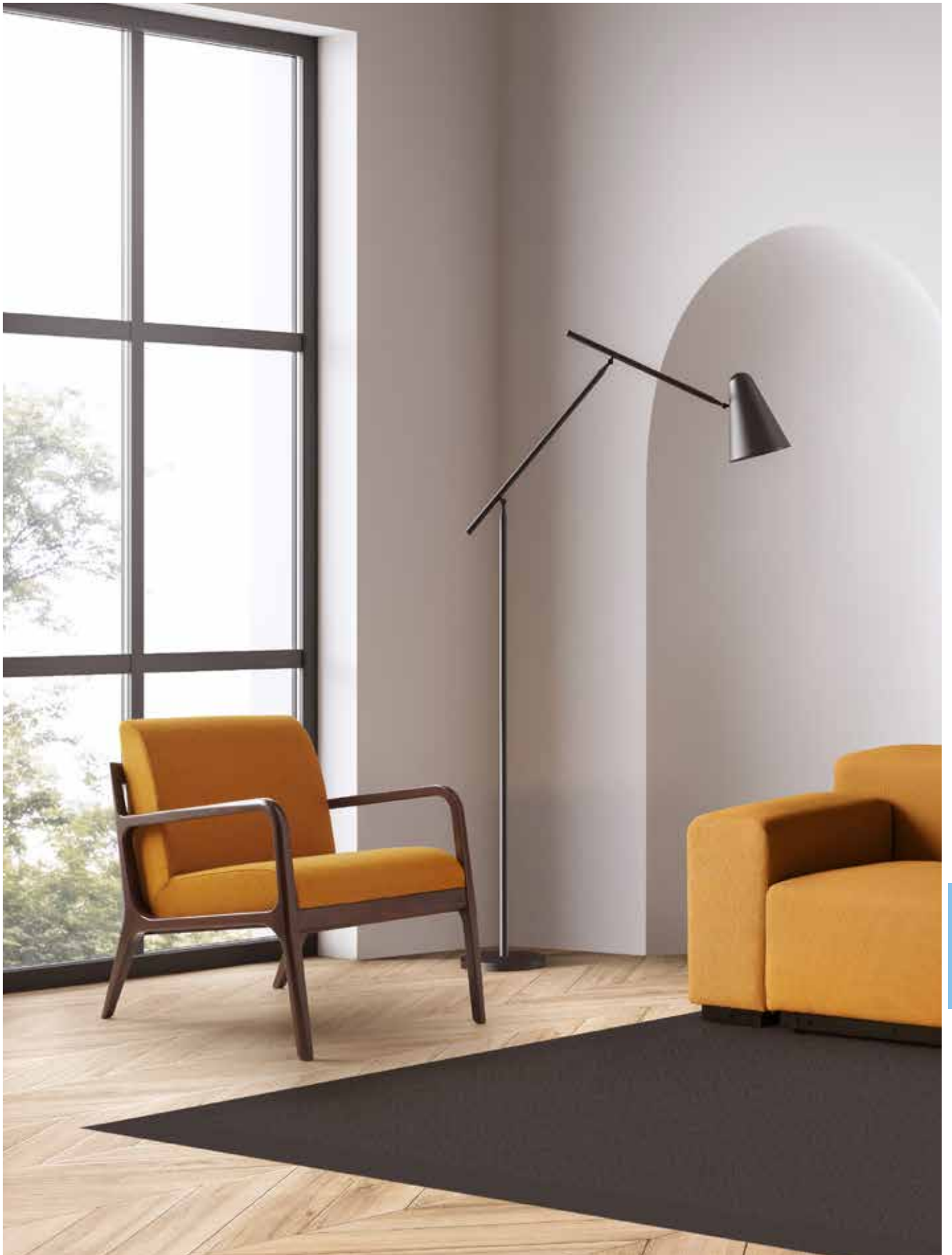

Reception,  
Breakout &  
Soft Seating

# RELO

SOFT SEATING, RECEPTION & BREAKOUT

NEW  
PRODUCT

5 Year  
Guarantee



Reception,  
Breakout &  
Soft Seating



# RELO

## SOFT SEATING, RECEPTION & BREAKOUT

# Relo

Crafted with patience, Relo takes inspiration from the smooth forms found on beaches, oceans and seas, aiming to transport the calming characteristics of these habitats to the workspace furthermore echoing their nomadic nature. Available in a Static or Swivel base with either a Fully Upholstered or Tech PU Shroud.

### Product Features



### Base Colours



Black

### Tech PU Shroud Options



Powder White



Simply Taupe



Charleston Grey



Babouche Yellow



Yearbridge Green



**RELOST1**  
Upholstered Shroud  
with Static Base

Band 1 .....	£2,369
Band 2 .....	£2,491
Band 3 .....	£2,658
Band 4 .....	£2,807
Band 5 .....	£2,978
Band 6 .....	£3,133
Band 7 .....	£3,281



**RELOST2**  
Tech PU Shroud  
with Static Base

Band 1 .....	£2,129
Band 2 .....	£2,177
Band 3 .....	£2,244
Band 4 .....	£2,303
Band 5 .....	£2,371
Band 6 .....	£2,433
Band 7 .....	£2,493



**RELOSW1**  
Upholstered Shroud  
with Swivel Base

Band 1 .....	£2,556
Band 2 .....	£2,678
Band 3 .....	£2,844
Band 4 .....	£2,992
Band 5 .....	£3,165
Band 6 .....	£3,320
Band 7 .....	£3,469



**RELOSW2**  
Tech PU Shroud  
with Swivel Base

Band 1 .....	£2,316
Band 2 .....	£2,365
Band 3 .....	£2,431
Band 4 .....	£2,490
Band 5 .....	£2,559
Band 6 .....	£2,621
Band 7 .....	£2,681



Reception,  
Breakout &  
Soft Seating

# KLYRO HIGH BACK

## RECEPTION, BREAKOUT & SOFT SEATING



Stylish, elegant and iconic. The Klyro Family is a fabulous new addition to the Gresham portfolio, forming an exciting selection of lounge and meeting chairs that between them offer an elegant and high-quality appearance, perfect for any environment. Klyro's crisp upholstery combines with several base options to form a versatile contemporary design ideal for both workplace and hospitality spaces. A family comprising of armchair, High wing back and Low back options, is complimented by both high and low back two-seat sofa models, all which share a strong family resemblance.

### Product Features



### Leg Colours



**KLY1H8**  
1 Seater Lounge Chair with Wooden Spindle Base

Band 1 .....	£1,303
Band 2 .....	£1,388
Band 3 .....	£1,509
Band 4 .....	£1,616
Band 5 .....	£1,739
Band 6 .....	£1,848
Band 7 .....	£1,955
Leather Group 1 .....	POA



**KLY1H1**  
1 Seater Lounge Chair with Wooden 4 Leg Base

Band 1 .....	£1,526
Band 2 .....	£1,612
Band 3 .....	£1,730
Band 4 .....	£1,839
Band 5 .....	£1,975
Band 6 .....	£2,072
Band 7 .....	£2,182
Leather Group 1 .....	POA



**KLY1H4**  
1 Seater Lounge Chair with Wooden Cradle Base

BBand 1 .....	£1,581
Band 2 .....	£1,670
Band 3 .....	£1,790
Band 4 .....	£1,894
Band 5 .....	£2,019
Band 6 .....	£2,129
Band 7 .....	£2,236
Leather Group 1 .....	POA



**KLY1H2**  
1 Seater Lounge Chair with Wooden Pyramid Swivel Base

Band 1 .....	£1,611
Band 2 .....	£1,698
Band 3 .....	£1,817
Band 4 .....	£1,925
Band 5 .....	£2,048
Band 6 .....	£2,158
Band 7 .....	£2,266
Leather Group 1 .....	POA



**KLY1H7**  
1 Seater Lounge Chair with Sled Base

Band 1 .....	£1,411
Band 2 .....	£1,434
Band 3 .....	£1,618
Band 4 .....	£1,723
Band 5 .....	£1,847
Band 6 .....	£1,957
Band 7 .....	£2,065
Leather Group 1 .....	POA



**KLY1H5**  
1 Seater Lounge Chair with 4 Star Swivel Base

Band 1 .....	£1,569
Band 2 .....	£1,655
Band 3 .....	£1,775
Band 4 .....	£1,880
Band 5 .....	£2,004
Band 6 .....	£2,115
Band 7 .....	£2,223
Leather Group 1 .....	POA



**KLY1H3**  
1 Seater Lounge Chair with 4 Leg Base

Band 1 .....	£1,577
Band 2 .....	£1,664
Band 3 .....	£1,784
Band 4 .....	£1,890
Band 5 .....	£2,014
Band 6 .....	£2,124
Band 7 .....	£2,232
Leather Group 1 .....	POA



**KLY2H4**  
2 Seater Lounge Chair with Wooden Cradle Base

Band 1 .....	£2,837
Band 2 .....	£2,989
Band 3 .....	£3,198
Band 4 .....	£3,384
Band 5 .....	£3,601
Band 6 .....	£3,792
Band 7 .....	£3,982
Leather Group 1 .....	POA



**KLY2H2**  
2 Seater Lounge Chair with Wooden Pyramid Base

Band 1 .....	£2,802
Band 2 .....	£2,956
Band 3 .....	£3,164
Band 4 .....	£3,350
Band 5 .....	£3,567
Band 6 .....	£3,760
Band 7 .....	£3,948
Leather Group 1 .....	POA



**KLY2H7**  
2 Seater Lounge Chair with Sled Base

Band 1 .....	£2,595
Band 2 .....	£2,749
Band 3 .....	£2,959
Band 4 .....	£3,143
Band 5 .....	£3,360
Band 6 .....	£3,552
Band 7 .....	£3,741
Leather Group 1 .....	POA



**KLY2H3**  
2 Seater Lounge Chair with 4 Leg Base

Band 1 .....	£2,906
Band 2 .....	£3,058
Band 3 .....	£3,268
Band 4 .....	£3,452
Band 5 .....	£3,669
Band 6 .....	£3,862
Band 7 .....	£4,050
Leather Group 1 .....	POA

Reception, Breakout & Soft Seating

5 Year  
Guarantee

NEW  
PRODUCT

# KLYRO HIGH BACK

RECEPTION, BREAKOUT & SOFT SEATING

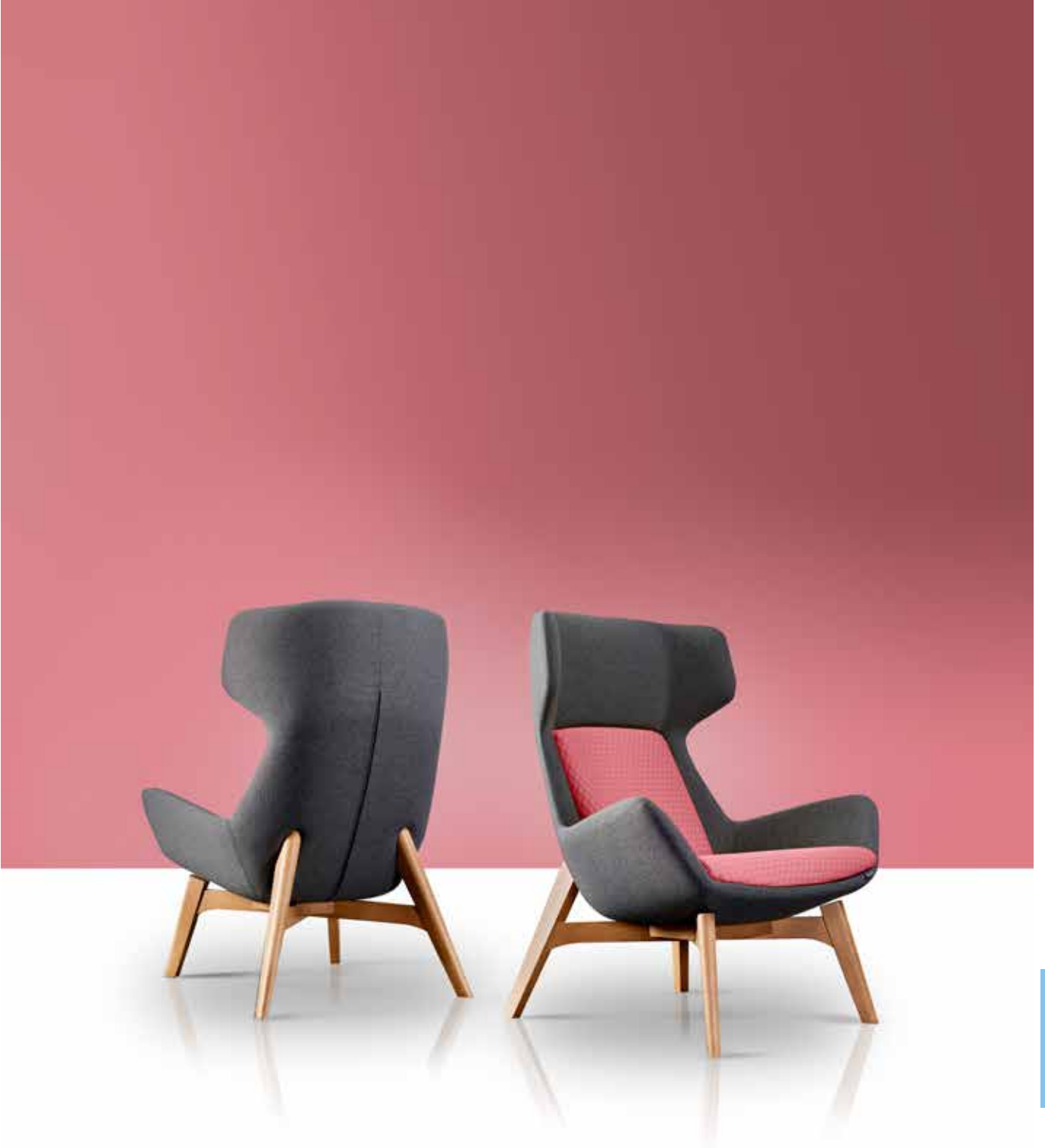

Reception,  
Breakout &  
Soft Seating

# KLYRO LOW BACK

## RECEPTION, BREAKOUT & SOFT SEATING



Stylish, elegant and iconic. The Klyro Family is a fabulous new addition to the Gresham portfolio, forming an exciting selection of lounge and meeting chairs that between them offer an elegant and high-quality appearance, perfect for any environment. Klyro's crisp upholstery combines with several base options to form a versatile contemporary design ideal for both workplace and hospitality spaces. A family comprising of armchair, High wing back and Low back options, is complimented by both high and low back two-seat sofa models, all which share a strong family resemblance.

### Product Features



### Leg Colours



**KLY1L8**  
1 Seater Lounge Chair with Wooden Spindle Base

Band 1 .....	£1,179
Band 2 .....	£1,257
Band 3 .....	£1,363
Band 4 .....	£1,453
Band 5 .....	£1,561
Band 6 .....	£1,659
Band 7 .....	£1,752
Leather Group 1 .....	POA



**KLY1L1**  
1 Seater Lounge Chair with Wooden 4 Leg Base

Band 1 .....	£1,404
Band 2 .....	£1,479
Band 3 .....	£1,584
Band 4 .....	£1,679
Band 5 .....	£1,785
Band 6 .....	£1,884
Band 7 .....	£1,978
Leather Group 1 .....	POA



**KLY1L4**  
1 Seater Lounge Chair with Wooden Cradle Base

Band 1 .....	£1,461
Band 2 .....	£1,538
Band 3 .....	£1,642
Band 4 .....	£1,736
Band 5 .....	£1,844
Band 6 .....	£1,938
Band 7 .....	£2,034
Leather Group 1 .....	POA



**KLY1L2**  
1 Seater Lounge Chair with Wooden Pyramid Swivel Base

Band 1 .....	£1,490
Band 2 .....	£1,565
Band 3 .....	£1,671
Band 4 .....	£1,764
Band 5 .....	£1,873
Band 6 .....	£1,968
Band 7 .....	£2,063
Leather Group 1 .....	POA



**KLY1L7**  
1 Seater Lounge Chair with Sled Base

Band 1 .....	£1,290
Band 2 .....	£1,366
Band 3 .....	£1,470
Band 4 .....	£1,563
Band 5 .....	£1,671
Band 6 .....	£1,767
Band 7 .....	£1,862
Leather Group 1 .....	POA



**KLY1L5**  
1 Seater Lounge Chair with 4 Star Swivel Base

Band 1 .....	£1,447
Band 2 .....	£1,522
Band 3 .....	£1,626
Band 4 .....	£1,721
Band 5 .....	£1,829
Band 6 .....	£1,925
Band 7 .....	£2,020
Leather Group 1 .....	POA



**KLY1L3**  
1 Seater Lounge Chair with 4 Leg Base

Band 1 .....	£1,455
Band 2 .....	£1,532
Band 3 .....	£1,637
Band 4 .....	£1,728
Band 5 .....	£1,836
Band 6 .....	£1,934
Band 7 .....	£2,028
Leather Group 1 .....	POA



**KLY2L4**  
2 Seater Lounge Chair with Wooden Cradle Base

Band 1 .....	£2,609
Band 2 .....	£2,751
Band 3 .....	£2,946
Band 4 .....	£3,116
Band 5 .....	£3,319
Band 6 .....	£3,497
Band 7 .....	£3,673
Leather Group 1 .....	POA



**KLY2L2**  
2 Seater Lounge Chair with Wooden Pyramid Base

Band 1 .....	£2,573
Band 2 .....	£2,717
Band 3 .....	£2,911
Band 4 .....	£3,083
Band 5 .....	£3,285
Band 6 .....	£3,464
Band 7 .....	£3,637
Leather Group 1 .....	POA



**KLY2L7**  
2 Seater Lounge Chair with Sled Base

Band 1 .....	£2,368
Band 2 .....	£2,509
Band 3 .....	£2,706
Band 4 .....	£2,877
Band 5 .....	£3,077
Band 6 .....	£3,257
Band 7 .....	£3,432
Leather Group 1 .....	POA



**KLY2L3**  
2 Seater Lounge Chair with 4 Leg Base

Band 1 .....	£2,677
Band 2 .....	£2,820
Band 3 .....	£3,014
Band 4 .....	£3,185
Band 5 .....	£3,388
Band 6 .....	£3,567
Band 7 .....	£3,741
Leather Group 1 .....	POA

5 Year  
Guarantee

NEW  
PRODUCT

# KLYRO LOW BACK

RECEPTION, BREAKOUT & SOFT SEATING



Reception,  
Breakout &  
Soft Seating

# KLYRO MEETING CHAIR

## RECEPTION, BREAKOUT & SOFT SEATING



Stylish, elegant and iconic. The Klyro Family is a fabulous new addition to the Gresham portfolio, forming an exciting selection of lounge and meeting chairs that between them offer an elegant and high-quality appearance, perfect for any environment. Klyro's crisp upholstery combines with several base options to form a versatile contemporary design ideal for both workplace and hospitality spaces. A family comprising of armchair, High wing back and Low back options, is complimented by both high and low back two-seat sofa models, all which share a strong family resemblance.

### Product Features



### Leg Colours



**KLY1AR8**  
Meeting Chair  
with Wooden Spindle Base

Band 1 .....	£909
Band 2 .....	£982
Band 3 .....	£1,038
Band 4 .....	£1,080
Band 5 .....	£1,133
Band 6 .....	£1,172
Band 7 .....	£1,207
Leather Group 1 .....	POA



**KLY1AR1**  
Meeting Chair  
with Wooden 4 Leg Base

Band 1 .....	£919
Band 2 .....	£978
Band 3 .....	£1,059
Band 4 .....	£1,133
Band 5 .....	£1,217
Band 6 .....	£1,293
Band 7 .....	£1,368
Leather Group 1 .....	POA



**KLY1AR7**  
Meeting Chair  
with Sled Base

Band 1 .....	£784
Band 2 .....	£845
Band 3 .....	£926
Band 4 .....	£999
Band 5 .....	£1,085
Band 6 .....	£1,160
Band 7 .....	£1,234
Leather Group 1 .....	POA



**KLY1AR5**  
Meeting Chair  
with 4 Leg Swivel Base

Band 1 .....	£985
Band 2 .....	£1,043
Band 3 .....	£1,128
Band 4 .....	£1,199
Band 5 .....	£1,284
Band 6 .....	£1,360
Band 7 .....	£1,433
Leather Group 1 .....	POA



**KLY1AR6**  
Meeting Chair  
with Pyramid Swivel Base

Band 1 .....	£941
Band 2 .....	£1,002
Band 3 .....	£1,085
Band 4 .....	£1,158
Band 5 .....	£1,241
Band 6 .....	£1,318
Band 7 .....	£1,398
Leather Group 1 .....	POA



**KLYP1**  
Pouf with  
4 Leg Base

Band 1 .....	£726
Band 2 .....	£756
Band 3 .....	£798
Band 4 .....	£833
Band 5 .....	£877
Band 6 .....	£913
Band 7 .....	£951
Leather Group 1 .....	POA



**KLYP5**  
Pouf with Metal  
4 Leg Base

Band 1 .....	£771
Band 2 .....	£800
Band 3 .....	£842
Band 4 .....	£879
Band 5 .....	£922
Band 6 .....	£959
Band 7 .....	£995
Leather Group 1 .....	POA



**KLYP2**  
Pouf with Wooden  
Pyramid Swivel Base

Band 1 .....	£696
Band 2 .....	£727
Band 3 .....	£769
Band 4 .....	£804
Band 5 .....	£847
Band 6 .....	£884
Band 7 .....	£923
Leather Group 1 .....	POA



5 Year  
Guarantee

NEW  
PRODUCT

# KLYRO MEETING CHAIR

RECEPTION, BREAKOUT & SOFT SEATING

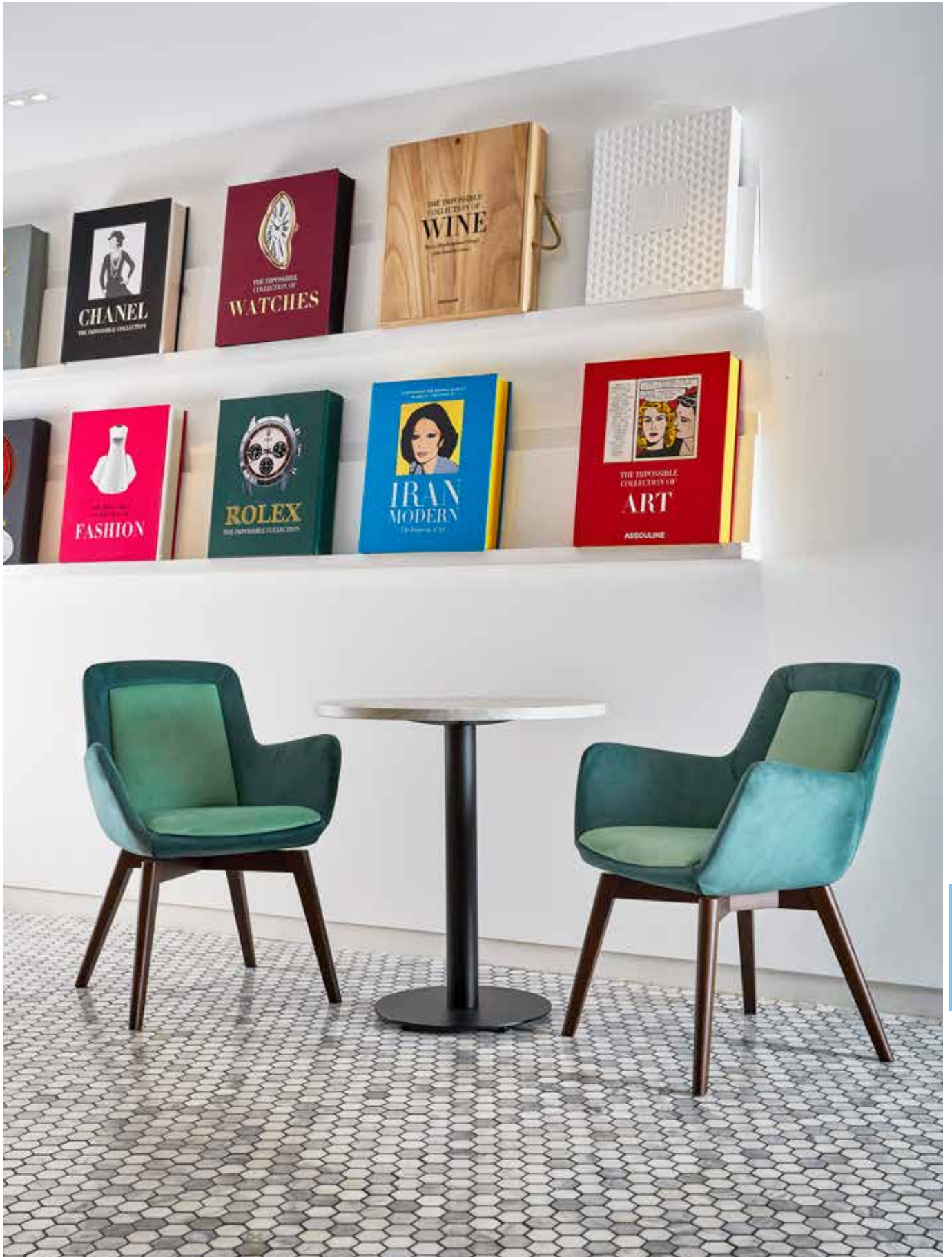

Reception,  
Breakout &  
Soft Seating

# STEPS SWIVEL BASE

## SOFT SEATING, RECEPTION & BREAKOUT

5 Year Guarantee

The Steps Swivel Base chair is ideal for meeting rooms and foyers. It comes with an optional high, wing-backed headrest perfect for executive breakout spaces or reception areas where style is paramount.

Available in a variety of fabrics with the option of being finished with a contrasting wood surround which accentuates the sophistication of the model.

### Product Features



#### Frame Colours

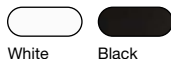

White Black

#### Show Wood Colours



Dark Walnut

#### Lacquer Colours



White Silver Grey

Subject to Surcharge, please contact our Sales Department for further information



**STCS**  
Compact Swivel No Surround

Band 3 .....	£1,085
Band 4 .....	£1,111
Band 5 .....	£1,142
Band 6 .....	£1,169
Band 7 .....	£1,194



**STCSAU**  
Compact Swivel Upholstered Surround

Band 3 .....	£1,356
Band 4 .....	£1,409
Band 5 .....	£1,469
Band 6 .....	£1,522
Band 7 .....	£1,577



**STCSAW**  
Compact Swivel Show Wood Surround

Band 3 .....	£1,415
Band 4 .....	£1,459
Band 5 .....	£1,508
Band 6 .....	£1,553
Band 7 .....	£1,595



**STLS**  
Lounge Swivel No Surround

Band 3 .....	£1,264
Band 4 .....	£1,297
Band 5 .....	£1,338
Band 6 .....	£1,373
Band 7 .....	£1,410



**STLSAU**  
Lounge Swivel Upholstered Surround

Band 3 .....	£1,585
Band 4 .....	£1,652
Band 5 .....	£1,729
Band 6 .....	£1,797
Band 7 .....	£1,870



**STLSAW**  
Lounge Swivel Show Wood Surround

Band 3 .....	£1,720
Band 4 .....	£1,780
Band 5 .....	£1,850
Band 6 .....	£1,912
Band 7 .....	£1,974



**STLSAHU**  
Lounge Swivel Upholstered Surround/Headrest

Band 3 .....	£2,052
Band 4 .....	£2,174
Band 5 .....	£2,310
Band 6 .....	£2,434
Band 7 .....	£2,557



**STLSAHW**  
Lounge Swivel Show Wood Surround/Headrest

Band 3 .....	£2,322
Band 4 .....	£2,441
Band 5 .....	£2,546
Band 6 .....	£2,654
Band 7 .....	£2,760

5 Year  
Guarantee

## STEPS SWIVEL BASE

SOFT SEATING, RECEPTION & BREAKOUT



Reception,  
Breakout &  
Soft Seating

# STEPS SWIVEL WOOD CLAD BASE

## SOFT SEATING, RECEPTION & BREAKOUT

5 Year Guarantee

The Steps Swivel Wood Clad Base chair is perfect for executive offices, finished with a contrasting wooden base which accentuates the sophistication of the model. It comes with an optional high, wing-backed headrest perfect for breakout spaces or reception areas where style is paramount.

Available in a variety of fabrics.

### Product Features



#### Base Colours



Dark Walnut

#### Show Wood Colours



Dark Walnut



**STCSB**  
Compact Swivel Wood Base  
No Surround

Band 3 .....	£1,578
Band 4 .....	£1,602
Band 5 .....	£1,633
Band 6 .....	£1,662
Band 7 .....	£1,685



**STCSAUB**  
Compact Swivel Wood Base  
Upholstered Surround

Band 3 .....	£1,846
Band 4 .....	£1,898
Band 5 .....	£1,959
Band 6 .....	£2,013
Band 7 .....	£2,067



**STCSAWB**  
Compact Swivel Wood Base  
Show Wood Surround

Band 3 .....	£1,903
Band 4 .....	£1,950
Band 5 .....	£1,999
Band 6 .....	£2,043
Band 7 .....	£2,088



**STLSB**  
Lounge Swivel Wood Base  
No Surround

Band 3 .....	£1,753
Band 4 .....	£1,789
Band 5 .....	£1,828
Band 6 .....	£1,866
Band 7 .....	£1,899



**STLSAUB**  
Lounge Swivel Wood Base  
Upholstered Surround

Band 3 .....	£2,075
Band 4 .....	£2,145
Band 5 .....	£2,221
Band 6 .....	£2,292
Band 7 .....	£2,359



**STLSAWB**  
Lounge Swivel Wood Base  
Show Wood Surround

Band 3 .....	£2,209
Band 4 .....	£2,271
Band 5 .....	£2,339
Band 6 .....	£2,402
Band 7 .....	£2,463



**STLSAHUB**  
Lounge Swivel Wood Base  
Upholstered Surround/Headrest

Band 3 .....	£2,543
Band 4 .....	£2,665
Band 5 .....	£2,803
Band 6 .....	£2,924
Band 7 .....	£3,046



**STLSAHWB**  
Lounge Swivel Wood Base  
Show Wood Surround/Headrest

Band 3 .....	£2,812
Band 4 .....	£2,931
Band 5 .....	£3,039
Band 6 .....	£3,145
Band 7 .....	£3,252

Reception,  
Breakout &  
Soft Seating

5 Year  
Guarantee

## STEPS SWIVEL WOOD CLAD BASE SOFT SEATING, RECEPTION & BREAKOUT



Reception,  
Breakout &  
Soft Seating

# STEPS SLED BASE

## SOFT SEATING, RECEPTION & BREAKOUT

5 Year Guarantee

The Steps Sled Base chair is ideal for meeting rooms and foyers. It comes with an optional high, wing-backed headrest perfect for executive breakout spaces or reception areas where style is paramount.

Available in a variety of fabrics with the option of being finished with a contrasting wood surround which accentuates the sophistication of the model.

### Product Features



### Frame Colours



### Show Wood Colours



### Lacquer Colours

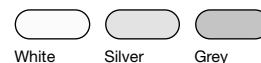

Subject to Surcharge, please contact our Sales Department for further information



**STCB**  
Compact Sled No Surround

Band 3 .....	£979
Band 4 .....	£1,004
Band 5 .....	£1,034
Band 6 .....	£1,061
Band 7 .....	£1,086



**STCBAU**  
Compact Sled Upholstered Surround

Band 3 .....	£1,247
Band 4 .....	£1,298
Band 5 .....	£1,360
Band 6 .....	£1,415
Band 7 .....	£1,467



**STCBAW**  
Compact Sled Show Wood Surround

Band 3 .....	£1,307
Band 4 .....	£1,353
Band 5 .....	£1,399
Band 6 .....	£1,444
Band 7 .....	£1,487



**STLB**  
Lounge Sled No Surround

Band 3 .....	£1,139
Band 4 .....	£1,174
Band 5 .....	£1,214
Band 6 .....	£1,250
Band 7 .....	£1,285



**STLBAU**  
Lounge Sled Upholstered Surround

Band 3 .....	£1,460
Band 4 .....	£1,528
Band 5 .....	£1,606
Band 6 .....	£1,675
Band 7 .....	£1,744



**STLBAW**  
Lounge Sled Show Wood Surround

Band 3 .....	£1,593
Band 4 .....	£1,654
Band 5 .....	£1,726
Band 6 .....	£1,787
Band 7 .....	£1,850



**STLBAHU**  
Lounge Sled Upholstered Surround/Headrest

Band 3 .....	£1,928
Band 4 .....	£2,049
Band 5 .....	£2,186
Band 6 .....	£2,309
Band 7 .....	£2,433



**STLBAHW**  
Lounge Sled Show Wood Surround/Headrest

Band 3 .....	£2,196
Band 4 .....	£2,302
Band 5 .....	£2,421
Band 6 .....	£2,529
Band 7 .....	£2,634

5 Year  
Guarantee

## STEPS SLED BASE

SOFT SEATING, RECEPTION & BREAKOUT



Reception,  
Breakout &  
Soft Seating

# STEPS 4 STAR BASE

## SOFT SEATING, RECEPTION & BREAKOUT

5 Year Guarantee

Adding to the Steps family of contemporary lounge seating, we have introduced stylish Aluminium die-cast pyramid bases that mirror the clean, sweeping lines of the upholstery whilst reducing both the physical and visual weight of the chairs.

Available in a variety of fabrics with the option of being finished in a contrasting wood surround which accentuates the sophistication of the model.

### Product Features



### Frame Colours



### Show Wood Colours



Dark Walnut

### Lacquer Colours

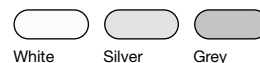

White Silver Grey

Subject to Surcharge, please contact our Sales Department for further information



**STCDG**  
Compact 4 Star No Surround

Band 3 .....	£1,085
Band 4 .....	£1,111
Band 5 .....	£1,142
Band 6 .....	£1,169
Band 7 .....	£1,194



**STCDGAU**  
Compact 4 Star Upholstered Surround

Band 3 .....	£1,356
Band 4 .....	£1,409
Band 5 .....	£1,469
Band 6 .....	£1,522
Band 7 .....	£1,577



**STCDGAW**  
Compact 4 Star Show Wood Surround

Band 3 .....	£1,415
Band 4 .....	£1,459
Band 5 .....	£1,508
Band 6 .....	£1,553
Band 7 .....	£1,595



**STLDG**  
Lounge 4 Star No Surround

Band 3 .....	£1,264
Band 4 .....	£1,297
Band 5 .....	£1,338
Band 6 .....	£1,373
Band 7 .....	£1,410



**STLDGAU**  
Lounge 4 Star Upholstered Surround

Band 3 .....	£1,585
Band 4 .....	£1,652
Band 5 .....	£1,729
Band 6 .....	£1,797
Band 7 .....	£1,870



**STLDGAW**  
Lounge 4 Star Show Wood Surround

Band 3 .....	£1,720
Band 4 .....	£1,780
Band 5 .....	£1,850
Band 6 .....	£1,912
Band 7 .....	£1,974



**STLDGAHU**  
Lounge 4 Star Upholstered Surround/Headrest

Band 3 .....	£2,052
Band 4 .....	£2,174
Band 5 .....	£2,310
Band 6 .....	£2,434
Band 7 .....	£2,557



**STLDGAHW**  
Lounge 4 Star Show Wood Surround/Headrest

Band 3 .....	£2,322
Band 4 .....	£2,441
Band 5 .....	£2,546
Band 6 .....	£2,654
Band 7 .....	£2,760

Reception,  
Breakout &  
Soft Seating



5 Year  
Guarantee

## STEPS 4 STAR BASE SOFT SEATING, RECEPTION & BREAKOUT



Reception,  
Breakout &  
Soft Seating

# STEPS CASTOR BASE

## SOFT SEATING, RECEPTION & BREAKOUT



Adding to the Steps family of contemporary lounge seating, we have introduced stylish Aluminium die-cast pyramid bases that mirror the clean, sweeping lines of the upholstery whilst reducing both the physical and visual weight of the chairs.

Available in a variety of fabrics with the option of being finished in a contrasting wood surround which accentuates the sophistication of the model.

### Product Features



### Frame Colours



### Show Wood Colours



### Lacquer Colours



Subject to Surcharge, please contact our Sales Department for further information



**STCDM**  
Compact Castor No Surround

Band 3 .....	£1,096
Band 4 .....	£1,123
Band 5 .....	£1,152
Band 6 .....	£1,180
Band 7 .....	£1,207



**STCDMAU**  
Compact Castor Upholstered Surround

Band 3 .....	£1,366
Band 4 .....	£1,418
Band 5 .....	£1,479
Band 6 .....	£1,532
Band 7 .....	£1,586



**STCDMAW**  
Compact Castor Show Wood Surround

Band 3 .....	£1,424
Band 4 .....	£1,469
Band 5 .....	£1,519
Band 6 .....	£1,562
Band 7 .....	£1,609

5 Year  
Guarantee

## STEPS CASTOR BASE

SOFT SEATING, RECEPTION & BREAKOUT



Reception,  
Breakout &  
Soft Seating

Kvadrat Remix 2 0123 (Band 4) Inner and Kvadrat Remix 2 0433 (Band 4) Outer with Black Castor Base

# HECTA

## SOFT SEATING, RECEPTION & BREAKOUT

5 Year Guarantee

This classically designed chair is both timeless and elegant. Its moulded seat shell and tailored upholstery provide a feeling of luxury and comfort.

The high-back wing chair also offers a sense of tranquillity due to it's acoustic properties and as such is perfect for breakout areas, lounges and busy spaces where an oasis of peace is desired.

The Hecta is available with three styles of base with either one-tone or two-tone upholstery which has comfort as well as a look which is contemporary as well as timeless and elegant.

### Metal Base Colours



### Wooden Base Colours



### Product Features



### Please Note

Available in selected fabrics only - Please contact our Sales Department for further information.



**HECW**  
Upholstered Arm Chair  
with 4 Leg Wooden Base

Band 1 .....	£1,729
Band 2 .....	£1,785
Band 3 .....	£1,862
Band 4 .....	£1,934
Band 5 .....	£2,013
Band 6 .....	£2,085
Band 7 .....	£2,155



**HECS**  
Upholstered Arm Chair  
with 4 Star Base

Band 1 .....	£1,770
Band 2 .....	£1,827
Band 3 .....	£1,901
Band 4 .....	£1,973
Band 5 .....	£2,054
Band 6 .....	£2,125
Band 7 .....	£2,195



**HECP**  
Upholstered Arm Chair  
with Pyramid Wooden Base

Band 1 .....	£1,775
Band 2 .....	£1,832
Band 3 .....	£1,908
Band 4 .....	£1,980
Band 5 .....	£2,060
Band 6 .....	£2,130
Band 7 .....	£2,203



Hecta: Camira Blazer Silverdale with Pyramid Wooden Base. Kulture: Capaldi Seat Unit Kvadrat Canvas 2 0114 & 0614

5 Year  
Guarantee

# HECTA

SOFT SEATING, RECEPTION & BREAKOUT



Reception,  
Breakout &  
Soft Seating

Hecta: Camira Blazer Eynesbury CUZ2W with 4 Star Base

# LITTLE HECTA

## SOFT SEATING, RECEPTION & BREAKOUT



Little Hecta joins the Gresham portfolio as a complementary side chair with strong ties to its sister product Hecta. A classic silhouette combined with detailed upholstery helps this versatile range provide a playful blend of luxury and comfort. Little Hecta is available with four styles of base and a choice of one or two-tone upholstery making it appropriate for specification through various applications in both hospitality and office environments.

- Moulded Foam Construction
- Fully Upholstered
- Steel Swivel Pedestal Base Options
- Wood Base Options
- Decorative Railroad Stitch Detail to Perimeter Seam
- Single or Two-tone Upholstery

### Product Features



#### Metal Base Colours



#### Wooden Base Colours



**HECWCH**  
Meeting Chair with  
Wooden 4 Leg Base

Band 1 .....	£969
Band 2 .....	£994
Band 3 .....	£1,026
Band 4 .....	£1,055
Band 5 .....	£1,090
Band 6 .....	£1,121
Band 7 .....	£1,152
Leather Group 1 .....	POA



**HECPCH**  
Meeting Chair with  
Wooden Pyramid Base

Band 1 .....	£962
Band 2 .....	£984
Band 3 .....	£1,016
Band 4 .....	£1,042
Band 5 .....	£1,072
Band 6 .....	£1,101
Band 7 .....	£1,129
Leather Group 1 .....	POA



**HECSCH**  
Meeting Chair with  
Metal 4 Star Base

Band 1 .....	£888
Band 2 .....	£908
Band 3 .....	£936
Band 4 .....	£960
Band 5 .....	£990
Band 6 .....	£1,016
Band 7 .....	£1,040
Leather Group 1 .....	POA



**HECKCH**  
Meeting Chair with  
Metal Pyramid Base

Band 1 .....	£942
Band 2 .....	£963
Band 3 .....	£995
Band 4 .....	£1,022
Band 5 .....	£1,052
Band 6 .....	£1,082
Band 7 .....	£1,107
Leather Group 1 .....	POA



5 Year  
Guarantee

NEW  
PRODUCT

# LITTLE HECTA

SOFT SEATING, RECEPTION & BREAKOUT

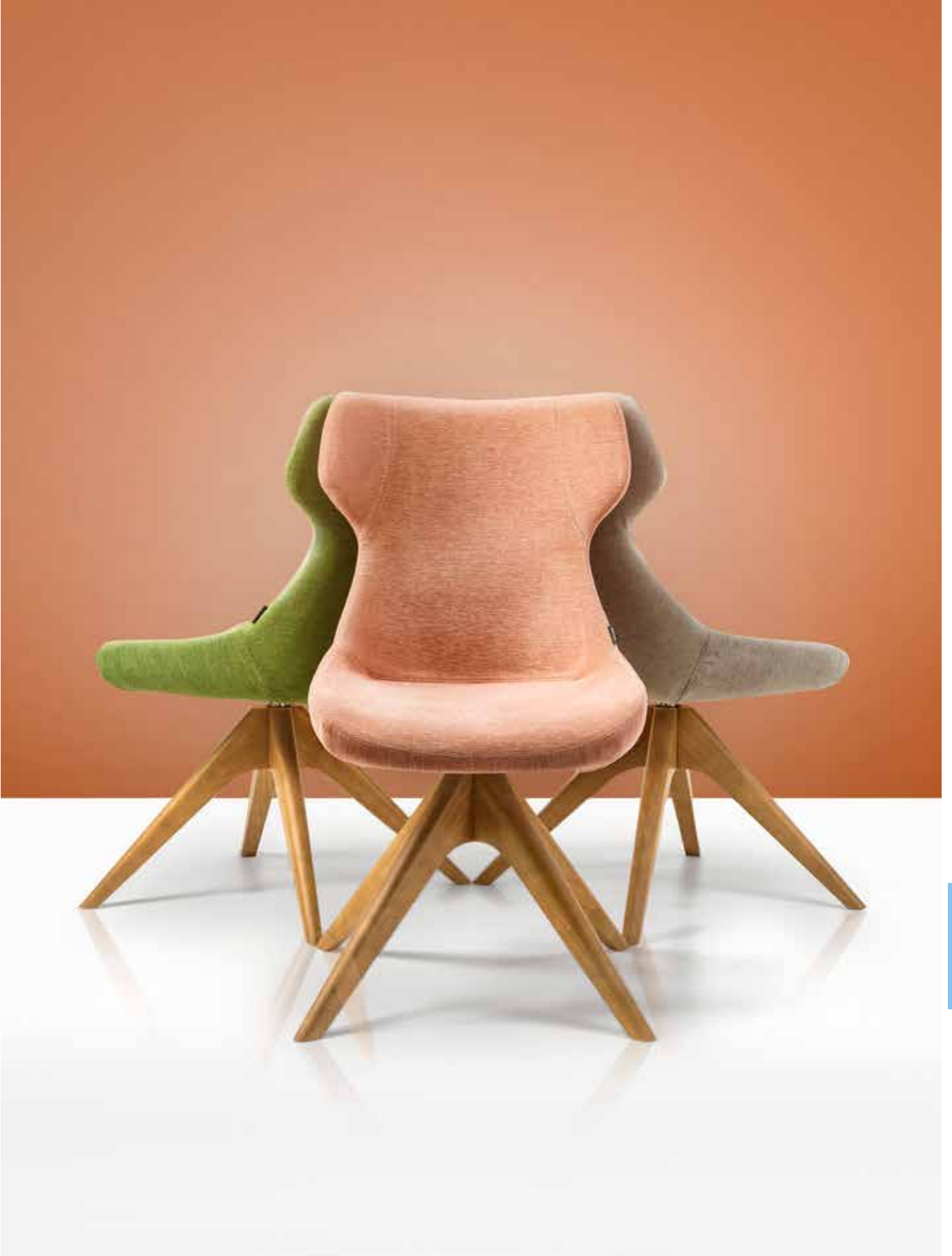

Reception,  
Breakout &  
Soft Seating

# MASCA

## SOFT SEATING, RECEPTION & BREAKOUT



Masca is a contemporary lounge chair family offered in high and medium back options, with either a polished 4-star base or wooden four legged frame.

This style is ideal for receptions, waiting or lounge areas where comfort and panache are paramount.

### Metal Base Colours



Polished

### Wooden Base Colours



Natural



Dark Walnut

### Product Features



### Please Note

Available in selected fabrics only - Please contact our Sales Department for further information.

<b>MASC11</b> Medium Back 4 Star Base (with Glides)	<b>MASC12</b> Medium Back 4 Star Castor Base (with Castors)	<b>MASC13</b> Medium Back Pyramid Base	<b>MASC14</b> Medium Back Pyramid Base (with Castors)	<b>MASC4</b> Medium Back Wooden Frame
Band 4 ..... £1,228 Band 5 ..... £1,254 Band 6 ..... £1,277 Band 7 ..... £1,298 Leather Group 1 ..... POA	Band 4 ..... £1,243 Band 5 ..... £1,269 Band 6 ..... £1,292 Band 7 ..... £1,313 Leather Group 1 ..... POA	Band 4 ..... £1,312 Band 5 ..... £1,338 Band 6 ..... £1,360 Band 7 ..... £1,384 Leather Group 1 ..... POA	Band 4 ..... £1,327 Band 5 ..... £1,354 Band 6 ..... £1,374 Band 7 ..... £1,397 Leather Group 1 ..... POA	Band 4 ..... £1,244 Band 5 ..... £1,307 Band 6 ..... £1,366 Band 7 ..... £1,425 Leather Group 1 ..... POA

<b>MASC21</b> High Back 4 Star Base (with Glides)	<b>MASC22</b> High Back 4 Star Castor Base (with Castors)	<b>MASC23</b> High Back Pyramid Base (with Glides)	<b>MASC24</b> High Back Pyramid Base (with Castors)	<b>MASC2</b> High Back Wooden Frame
Band 4 ..... £1,389 Band 5 ..... £1,416 Band 6 ..... £1,438 Band 7 ..... £1,460 Leather Group 1 ..... POA	Band 4 ..... £1,402 Band 5 ..... £1,429 Band 6 ..... £1,452 Band 7 ..... £1,475 Leather Group 1 ..... POA	Band 4 ..... £1,440 Band 5 ..... £1,465 Band 6 ..... £1,487 Band 7 ..... £1,513 Leather Group 1 ..... POA	Band 4 ..... £1,454 Band 5 ..... £1,479 Band 6 ..... £1,500 Band 7 ..... £1,524 Leather Group 1 ..... POA	Band 4 ..... £1,402 Band 5 ..... £1,477 Band 6 ..... £1,548 Band 7 ..... £1,620 Leather Group 1 ..... POA

Reception, Breakout & Soft Seating



5 Year  
Guarantee

# MASCA

SOFT SEATING, RECEPTION & BREAKOUT

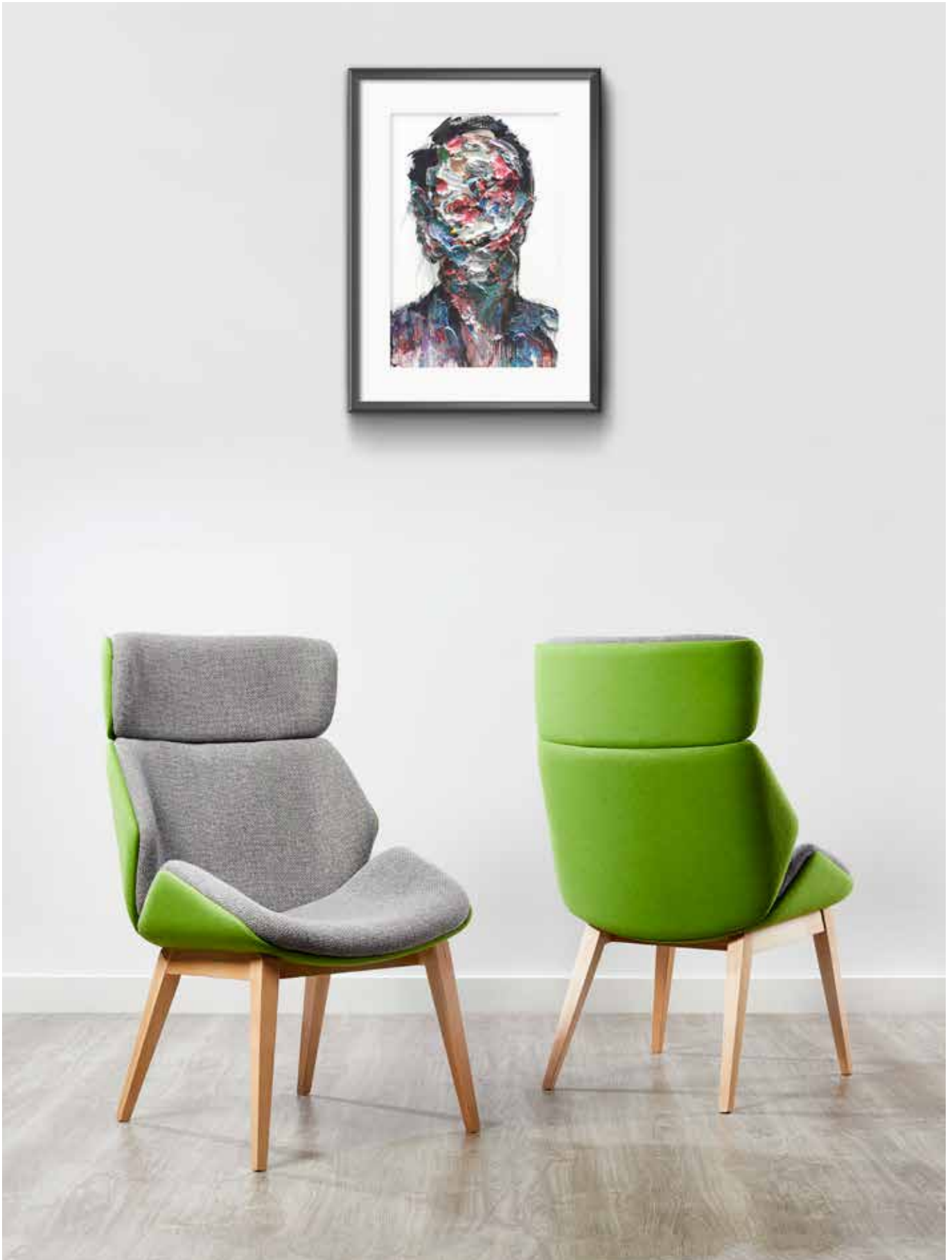

Reception,  
Breakout &  
Soft Seating

Camira Blazer Newport CUZ1L (Band 4) Outer and Camira Advantage Mineral AD010 (Band 1) Inner with Natural Wooden Legs

# BETSY

## SOFT SEATING, RECEPTION & BREAKOUT



Betsy has been designed as a contemporary tub lounge chair collection with sweeping curves and a selection of stylish frames. Available in single and two seat variants, the Betsy family can be used throughout corporate environments where comfort and light-weight visual style is key.

- Available in Two-tone fabric and a choice of bases.
- Generous seat & back for added comfort.
- Four star bases fitted with gas lift mechanism, raising the chair from reception to work/dining height.
- Matching tables available.

### Frame Finishes

#### Metal

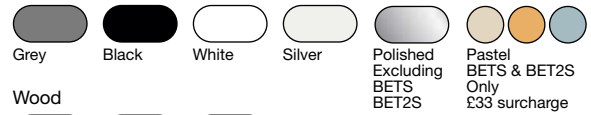

#### Wood



### Product Features



### Please Note

Band 1 and Band 2 are available as selected fabrics only - Please contact our Sales Department for further information.



**BET2S**  
Two Seat Sofa Skid Frame



**BET2Z**  
Two Seat Sofa Wooden Frame

Band 1 .....	£1,216
Band 2 .....	£1,268
Band 3 .....	£1,346
Band 4 .....	£1,420
Band 5 .....	£1,496
Band 6 .....	£1,568
Band 7 .....	£1,639

Band 1 .....	£1,439
Band 2 .....	£1,492
Band 3 .....	£1,573
Band 4 .....	£1,641
Band 5 .....	£1,721
Band 6 .....	£1,793
Band 7 .....	£1,866



Camira Rivet Crucibal EGL24 (Band 1) Inner and Svensson Accessoire Bok (Band 6) Outer with Black Skid Frame

# BETSY

## SOFT SEATING, RECEPTION & BREAKOUT



**BETS**  
Skid Frame

Band 1 .....	£650
Band 2 .....	£675
Band 3 .....	£714
Band 4 .....	£750
Band 5 .....	£790
Band 6 .....	£825
Band 7 .....	£859
Leather Group 1 .....	POA



**BET4**  
Four Star Base  
(With Glides)  
**R / T**

Band 1 .....	£866
Band 2 .....	£889
Band 3 .....	£932
Band 4 .....	£967
Band 5 .....	£1,005
Band 6 .....	£1,042
Band 7 .....	£1,077
Leather Group 1 .....	POA



**BET4W**  
Four Star Base  
(With Castors)  
**T**

Band 1 .....	£884
Band 2 .....	£913
Band 3 .....	£953
Band 4 .....	£986
Band 5 .....	£1,027
Band 6 .....	£1,062
Band 7 .....	£1,101
Leather Group 1 .....	POA



**BETP**  
Pyramid Base  
(With Glides)  
**R**

Band 1 .....	£909
Band 2 .....	£934
Band 3 .....	£973
Band 4 .....	£1,009
Band 5 .....	£1,048
Band 6 .....	£1,084
Band 7 .....	£1,119
Leather Group 1 .....	POA



**BETPW**  
Pyramid Base  
(With Castors)  
**R**

Band 1 .....	£924
Band 2 .....	£953
Band 3 .....	£992
Band 4 .....	£1,027
Band 5 .....	£1,067
Band 6 .....	£1,104
Band 7 .....	£1,138
Leather Group 1 .....	POA



**BETZ**  
Wooden Frame

Band 1 .....	£1,003
Band 2 .....	£1,029
Band 3 .....	£1,071
Band 4 .....	£1,106
Band 5 .....	£1,144
Band 6 .....	£1,181
Band 7 .....	£1,215
Leather Group 1 .....	POA

**R.** Optional Auto Return Column available.  
(Suffix code with R. Example: BET4R)  
Surcharge.....£13

**T.** Optional Tilt Mechanism available.  
(Suffix code with T. Example: BET4T)  
Surcharge.....£46



From L/R Camira Rivet Spark EGL10 (Band 1) Inner and Svensson Accessoire Riff (Band 6) Outer with White Pyramid Base  
Camira Rivet Crucibal EGL24 (Band 1) Inner and Svensson Accessoire Bok (Band 6) Outer with Black Skid Frame with White Pyramid Base

# ADORE

## SOFT SEATING, RECEPTION & BREAKOUT

5 Year Guarantee

As the name suggests, you'll just love this family of contemporary lounge chairs with matching stool.

- The concave form of its shell holds you in place for a relaxing sit.
- Choice of widths and frame options.
- Easy to specify throughout your working landscape.

### Frame Colours

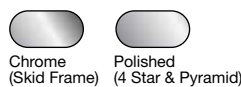

### Product Features



### Please Note

Available in selected fabrics only - Please contact our Sales Department for further information.



**AD1**  
Low Skid Frame with Headrest

Band 1 .....	£763
Band 2 .....	£792
Band 3 .....	£848
Band 4 .....	£899
Band 5 .....	£947
Band 6 .....	£997
Band 7 .....	£1,046
Leather Group 1 .....	POA



**AD2**  
Low Skid Frame

Band 1 .....	£675
Band 2 .....	£703
Band 3 .....	£746
Band 4 .....	£783
Band 5 .....	£822
Band 6 .....	£863
Band 7 .....	£902
Leather Group 1 .....	POA



**AD3**  
Skid Frame Stool  
760mm Seat Height

Band 1 .....	£508
Band 2 .....	£520
Band 3 .....	£547
Band 4 .....	£566
Band 5 .....	£592
Band 6 .....	£615
Band 7 .....	£638
Leather Group 1 .....	POA



**AD5**  
Skid Frame

Band 1 .....	£615
Band 2 .....	£638
Band 3 .....	£680
Band 4 .....	£717
Band 5 .....	£754
Band 6 .....	£797
Band 7 .....	£835
Leather Group 1 .....	POA



**AD11**  
4 Star Base  
(with Glides)

Band 1 .....	£782
Band 2 .....	£800
Band 3 .....	£825
Band 4 .....	£851
Band 5 .....	£877
Band 6 .....	£901
Band 7 .....	£923
Leather Group 1 .....	POA



**AD12**  
4 Star Base  
(with Castors)

Band 1 .....	£798
Band 2 .....	£814
Band 3 .....	£842
Band 4 .....	£866
Band 5 .....	£889
Band 6 .....	£915
Band 7 .....	£938
Leather Group 1 .....	POA



**AD13**  
Pyramid Base  
(with Glides)

Band 1 .....	£871
Band 2 .....	£886
Band 3 .....	£914
Band 4 .....	£937
Band 5 .....	£964
Band 6 .....	£986
Band 7 .....	£1,012
Leather Group 1 .....	POA



**AD14**  
Pyramid Base  
(with Castors)

Band 1 .....	£883
Band 2 .....	£902
Band 3 .....	£929
Band 4 .....	£953
Band 5 .....	£979
Band 6 .....	£1,002
Band 7 .....	£1,026
Leather Group 1 .....	£1,026

5 Year  
Guarantee

# ADORE

SOFT SEATING, RECEPTION & BREAKOUT



Camira Synergy Compose LDS72 (Band 3) with Chrome Pyramid Base

Reception,  
Breakout &  
Soft Seating

# MOTILE

## SOFT SEATING, RECEPTION & BREAKOUT

5 Year Guarantee

These compact lounge chairs are noted for their modern stylish appearance.

- Panelled form upholstery for added style.
- Offered in a number of frame options.

### Base Colours

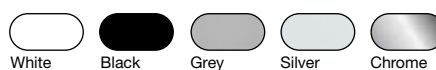

### Product Features



### Please Note

Available in selected fabrics only -  
Please contact our Sales Department for further information.



**MOTSF**  
Skid Frame

Band 1 .....	£1,154
Band 2 .....	£1,185
Band 3 .....	£1,239
Band 4 .....	£1,288
Band 5 .....	£1,336
Band 6 .....	£1,385
Band 7 .....	£1,433
Leather Group 1 .....	POA



**MOT4BR**  
4 Star Base with Glides  
and Auto Return

Band 1 .....	£1,229
Band 2 .....	£1,257
Band 3 .....	£1,307
Band 4 .....	£1,354
Band 5 .....	£1,400
Band 6 .....	£1,447
Band 7 .....	£1,491
Leather Group 1 .....	POA



Camira Synergy Affinity LDS74 (Band 3) Inner and Camira Rivet Forge EGL12 (Band 1) Outer with White Skid Frame

The LG30 Classic lounge chair offers the ultimate in style and comfort for waiting rooms, reception areas, hospitality and modern workspaces. With lacquered wooden legs and a durable upholstered shell in a range of fabric options, this soft seating option is a fresh alternative to conventional lounge or reception seating. The simple, clean silhouette of the LG30 Classic chair suits virtually any interior for a modern, updated look.

### Product Features



### Wood Colours



Ash



**LG30AT**  
4 Leg Wooden Base  
Tapered Leg

Band 1 .....	£817
Band 2 .....	£852
Band 3 .....	£903
Band 4 .....	£949
Band 5 .....	£999
Band 6 .....	£1,045
Band 7 .....	£1,091



**LG30HA**  
4 Leg Wooden Base  
Tapered Leg

Band 1 .....	£845
Band 2 .....	£879
Band 3 .....	£923
Band 4 .....	£963
Band 5 .....	£1,010
Band 6 .....	£1,053
Band 7 .....	£1,092



**LG30ST**  
4 Leg Wooden Base  
Tapered Leg

Band 1 .....	£958
Band 2 .....	£991
Band 3 .....	£1,036
Band 4 .....	£1,076
Band 5 .....	£1,124
Band 6 .....	£1,165
Band 7 .....	£1,207



Gabriel Crisp 04432 Back and 04411 Seat (Band 4) (Red) Gabriel Crisp 04741 (Band 4) (Blue)

# BETIBO

## CONFERENCE, MEETING & CAFÉ SEATING



Gresham's new Betibo family of chairs. Designed for high-volume use, the Betibo family is perfect for use in conference rooms, cafes, or university meeting rooms where you have large groups of people to accommodate. Available as a standard-sized chair with or without arms, your guests will enjoy ultimate comfort during their visit. The Betibo family also includes a stool option that pairs perfectly with high tables such as our Deck, GD10 or GD1 Poseur brands to create a functional yet stylish work area. Alternatively, the stool will complement your breakfast bar or standing tables to create a relaxed environment for any hospitality area. Available in a variety of fabrics, our Betibo family of chairs will fit into your design scheme perfectly.

### Product Features



### Wooden Base Colours



**TIB1**  
Chair with Wooden Legs

Band 1 .....	£383
Band 2 .....	£418
Band 3 .....	£466
Band 4 .....	£508
Band 5 .....	£558
Band 6 .....	£602
Band 7 .....	£645
Leather Group 1 .....	POA



**TIB1A**  
Chair with Wooden Legs & Arm

Band 1 .....	£477
Band 2 .....	£511
Band 3 .....	£561
Band 4 .....	£602
Band 5 .....	£652
Band 6 .....	£695
Band 7 .....	£740
Leather Group 1 .....	POA



**TIB2**  
Stool with Wooden Legs

Band 1 .....	£513
Band 2 .....	£533
Band 3 .....	£561
Band 4 .....	£584
Band 5 .....	£612
Band 6 .....	£636
Band 7 .....	£660
Leather Group 1 .....	POA



Reception,  
Breakout &  
Soft Seating



5 Year Guarantee

# SOFT SEATING, RECEPTION & BREAKOUT **LG10**

The LG10 combines a number of tactile materials to create a striking furniture piece. Its generously padded upholstery provides ultimate style and comfort. The innovative design incorporates a plastic frame which is available in both black and white. Combined with beech arms and exposed fixing details, this product is truly unique. LG10 was designed to suit a variety of interior spaces and to provide maximum visual impact.

## Product Features



### Frame Colours



White

### Wood Arm Colours



Beech

### Additional Information

Available in a variety of fabrics.



LG10A  
1 Seater



LG10B  
2 Seater

Band 1 .....	£1,454
Band 2 .....	£1,506
Band 3 .....	£1,585
Band 4 .....	£1,653
Band 5 .....	£1,732
Band 6 .....	£1,802
Band 7 .....	£1,873

Band 1 .....	£1,992
Band 2 .....	£2,166
Band 3 .....	£2,429
Band 4 .....	£2,663
Band 5 .....	£2,920
Band 6 .....	£3,154
Band 7 .....	£3,386



Panaz Linear 919 Zinc (Band 3)

Reception,  
Breakout &  
Soft Seating

# OPSO

## CONFERENCE, MEETING & CAFÉ SEATING



### Opso Designed by Richard Jones

Introducing Opso, a brand new, innovative soft seating bench designed by Richard Jones. Renowned for his pared back, understated creations. This inverted triangular bench is visually eye-catching and will create a lasting impression; and with the accompanying table, it can be arranged into a myriad of configurations to suit any environment. Available in single or two tone fabrics with oak Texwood legs, the Opso offers an oasis of comfort within the workplace.

#### Product Features



#### Frame Colours



Oak  
Texwood

#### Additional Information

Available in a variety of fabrics.



OP14BENSEAT  
Upholstered Bench

Band 1	£1,753
Band 2	£1,806
Band 3	£1,875
Band 4	£1,937
Band 5	£2,012
Band 6	£2,076
Band 7	£2,140



Code	Description	Band 1	Band 2	Band 3	Band 4	Band 5	Band 6	Band 7
OP3WAYTAB	3 Way Linking Table	£1,065	£1,087	£1,114	£1,139	£1,170	£1,195	£1,222
OP4WAYTAB	4 Way Linking Table	£1,065	£1,087	£1,114	£1,139	£1,170	£1,195	£1,222



Reception,  
Breakout &  
Soft Seating

Opso Bench in AGUA Mystique Titan Midnight and AGUA Finezza Collection Ebony

5 Year  
Guarantee

NEW  
PRODUCT

# OPSO

## SOFT SEATING, RECEPTION & BREAKOUT

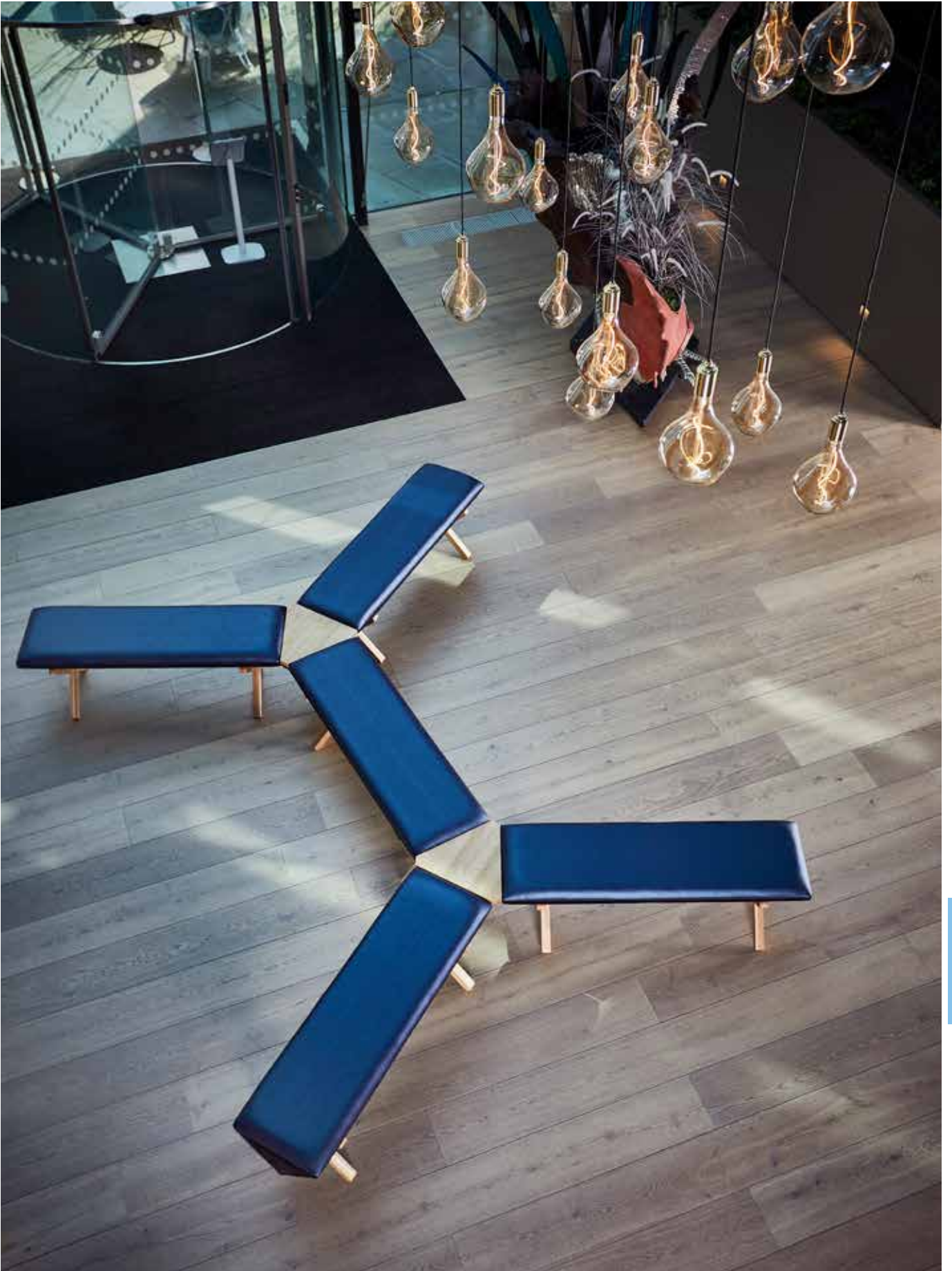

Opso Bench in AGUA Mystique Titan Midnight and AGUA Finezza Collection Ebony

Reception,  
Breakout &  
Soft Seating

# GALLEN

## SOFT SEATING, RECEPTION & BREAKOUT

5 Year Guarantee

A mix of comfort and style, Gallen combines a more traditional buttoned back cushion with a modern, contemporary shape.

- Large seat cushions for increased comfort.
- Tapered wooden legs.
- Mono seat and back cushions.
- Button detailing as standard.
- Available with optional fitted service modules
- Each module contains 1x UK power outlet and 1x twin USB fast charge outlet. Supplied with 3m lead to UK plug.
- Suffix code with 'P' to specify sofa with service module.

### Leg Colours



### Product Features



### Optional Extras

2 & 3 Seater Service Module surcharge	£735
1 Seater Service Module surcharge	£407

1x USB-A  
1x USB-C



TWIN USB  
FAST CHARGE



**GAL1H**  
1 Seater High Back

Band 1 .....	£2,975
Band 2 .....	£3,137
Band 3 .....	£3,350
Band 4 .....	£3,550
Band 5 .....	£3,774
Band 6 .....	£3,972
Band 7 .....	£4,174



**GAL2H**  
2 Seater High Back

Band 1 .....	£3,867
Band 2 .....	£4,133
Band 3 .....	£4,482
Band 4 .....	£4,816
Band 5 .....	£5,186
Band 6 .....	£5,516
Band 7 .....	£5,844



**GAL3H**  
3 Seater High Back

Band 1 .....	£4,883
Band 2 .....	£5,257
Band 3 .....	£5,749
Band 4 .....	£6,216
Band 5 .....	£6,735
Band 6 .....	£7,197
Band 7 .....	£7,643



Camira Synergy Kindness LDS51 (Band 3) Sofa and Armchair with Camira Synergy Quilt Channel Serendipity QSC08 (Band 7) High Back with Black Wood Feet



**GAL1**  
1 Seater With Arms

Band 1 .....	£1,747
Band 2 .....	£1,827
Band 3 .....	£1,961
Band 4 .....	£2,083
Band 5 .....	£2,208
Band 6 .....	£2,331
Band 7 .....	£2,450
Leather Group 1 .....	£2,543



**GAL2**  
2 Seater With Arms

Band 1 .....	£2,337
Band 2 .....	£2,449
Band 3 .....	£2,656
Band 4 .....	£2,837
Band 5 .....	£3,021
Band 6 .....	£3,204
Band 7 .....	£3,385
Leather Group 1 .....	£3,701



**GAL3**  
3 Seater With Arms

Band 1 .....	£2,824
Band 2 .....	£2,970
Band 3 .....	£3,230
Band 4 .....	£3,464
Band 5 .....	£3,692
Band 6 .....	£3,924
Band 7 .....	£4,160
Leather Group 1 .....	£4,464



**GALC**  
Corner Unit

Band 1 .....	£2,824
Band 2 .....	£2,970
Band 3 .....	£3,230
Band 4 .....	£3,464
Band 5 .....	£3,692
Band 6 .....	£3,924
Band 7 .....	£4,160
Leather Group 1 .....	£4,464



Camira Synergy Guild LDS63 (Band 3) Armchair with Natural Wood Feet

# GALLEN

## SOFT SEATING, RECEPTION & BREAKOUT

5 Year Guarantee



**GAL1R**  
1 Seater with R/Hand Arm

Band 1 .....	£1,747
Band 2 .....	£1,827
Band 3 .....	£1,961
Band 4 .....	£2,083
Band 5 .....	£2,208
Band 6 .....	£2,331
Band 7 .....	£2,450
Leather Group 1 .....	£2,543



**GAL1L**  
1 Seater with L/Hand Arm

Band 1 .....	£1,747
Band 2 .....	£1,827
Band 3 .....	£1,961
Band 4 .....	£2,083
Band 5 .....	£2,208
Band 6 .....	£2,331
Band 7 .....	£2,450
Leather Group 1 .....	£2,543



**GAL1X**  
1 Seater without Arms

Band 1 .....	£1,747
Band 2 .....	£1,827
Band 3 .....	£1,961
Band 4 .....	£2,083
Band 5 .....	£2,208
Band 6 .....	£2,331
Band 7 .....	£2,450
Leather Group 1 .....	£2,543



**GAL2R**  
2 Seater with R/Hand Arm

Band 1 .....	£2,337
Band 2 .....	£2,449
Band 3 .....	£2,656
Band 4 .....	£2,837
Band 5 .....	£3,021
Band 6 .....	£3,204
Band 7 .....	£3,385
Leather Group 1 .....	£3,701



**GAL2L**  
2 Seater with L/Hand Arm

Band 1 .....	£2,337
Band 2 .....	£2,449
Band 3 .....	£2,656
Band 4 .....	£2,837
Band 5 .....	£3,021
Band 6 .....	£3,204
Band 7 .....	£3,385
Leather Group 1 .....	£3,701



**GAL2X**  
2 Seater without Arms

Band 1 .....	£2,337
Band 2 .....	£2,449
Band 3 .....	£2,656
Band 4 .....	£2,837
Band 5 .....	£3,021
Band 6 .....	£3,204
Band 7 .....	£3,385
Leather Group 1 .....	£3,701



Camira Blazer Silcoates CUZ30 (Band 4) Sofa & Cushion and Camira Xtreme Solano YS072 (Band 1) Cushion (Optional service modules shown)



# GALLEN

## SOFT SEATING, RECEPTION & BREAKOUT



**GAL3R**  
3 Seater with R/Hand Arm

Band 1 .....	£2,824
Band 2 .....	£2,970
Band 3 .....	£3,230
Band 4 .....	£3,464
Band 5 .....	£3,692
Band 6 .....	£3,924
Band 7 .....	£4,160
Leather Group 1 .....	£4,464



**GAL3L**  
3 Seater with L/Hand Arm

Band 1 .....	£2,824
Band 2 .....	£2,970
Band 3 .....	£3,230
Band 4 .....	£3,464
Band 5 .....	£3,692
Band 6 .....	£3,924
Band 7 .....	£4,160
Leather Group 1 .....	£4,464



**GAL3X**  
3 Seater without Arms

Band 1 .....	£2,824
Band 2 .....	£2,970
Band 3 .....	£3,230
Band 4 .....	£3,464
Band 5 .....	£3,692
Band 6 .....	£3,924
Band 7 .....	£4,160
Leather Group 1 .....	£4,464



Reception,  
Breakout &  
Soft Seating

Sofa & Button details Steel 911 Allure & Cushions Compose LDS72 Seat Cushions Compose LDS72

# ALVIER WOODEN LEG

## SOFT SEATING, RECEPTION & BREAKOUT

5 Year Guarantee

This elegant seating collection comprises of a single and two seat sofa with bench options.

- Solid wood frame construction.
- Accompanying coffee tables, available in a variety of top finishes.
- Perfect collection for breakout, reception, hotel lobby or executive office environments.

### Frame Colours



### Product Features



**NS1BW**  
1 Seater  
with Arms

Band 1	£1,522
Band 2	£1,562
Band 3	£1,644
Band 4	£1,666
Band 5	£1,779
Band 6	£1,851
Band 7	£1,919
Leather Group 1	POA



**NS2BW**  
2 Seater  
with Arms

Band 1	£2,179
Band 2	£2,244
Band 3	£2,368
Band 4	£2,477
Band 5	£2,587
Band 6	£2,695
Band 7	£2,808
Leather Group 1	POA



**NS1HW**  
1 Seater Fixed Back Cushion  
with Arms

Band 1	£1,751
Band 2	£1,807
Band 3	£1,914
Band 4	£2,004
Band 5	£2,094
Band 6	£2,185
Band 7	£2,278
Leather Group 1	POA



**NS2HW**  
2 Seater Fixed Back Cushions  
with Arms

Band 1	£2,639
Band 2	£2,730
Band 3	£2,899
Band 4	£3,046
Band 5	£3,195
Band 6	£3,344
Band 7	£3,491
Leather Group 1	POA



**NS2PBW**  
2 Seater

Band 1	£2,179
Band 2	£2,244
Band 3	£2,368
Band 4	£2,477
Band 5	£2,587
Band 6	£2,695
Band 7	£2,803
Leather Group 1	POA



**NS2PHW**  
2 Seater with Fixed Back  
Cushions

Band 1	£2,639
Band 2	£2,730
Band 3	£2,899
Band 4	£3,046
Band 5	£3,195
Band 6	£3,344
Band 7	£3,491
Leather Group 1	POA



**NS1W**  
Small Bench

Band 1	£954
Band 2	£981
Band 3	£1,027
Band 4	£1,071
Band 5	£1,110
Band 6	£1,152
Band 7	£1,194
Leather Group 1	POA



**NS2W**  
2 Seater Large Bench

Band 1	£1,215
Band 2	£1,255
Band 3	£1,326
Band 4	£1,387
Band 5	£1,448
Band 6	£1,509
Band 7	£1,574
Leather Group 1	POA



**NST069W**  
Table

980W x 680D x 275H	
Group Z	£577



**NSCP**  
Loose Plain Cushion

Band 1	£131
Band 2	£141
Band 3	£150
Band 4	£160
Band 5	£168
Band 6	£177
Band 7	£190
Leather Group 1	POA



**NSCB**  
Loose Piped and  
Buttoned Cushion

Band 1	£153
Band 2	£160
Band 3	£171
Band 4	£181
Band 5	£191
Band 6	£202
Band 7	£209
Leather Group 1	POA



5 Year  
Guarantee

## ALVIER WOODEN LEG SOFT SEATING, RECEPTION & BREAKOUT



Reception,  
Breakout &  
Soft Seating

Kvadrat Steelcut Trio 3 0466 (Band 7) Outer and Kvadrat Steelcut Trio 3 0176 (Band 7) Inner

# ALVIER SLED LEG

## SOFT SEATING, RECEPTION & BREAKOUT



This elegant seating collection comprises of a single and two seat sofa with bench options.

- Stylish steel sled frame construction.
- Accompanying coffee tables, available in a variety of top finishes.
- Perfect collection for breakout, reception, hotel lobby or executive office environments.

### Frame Colours

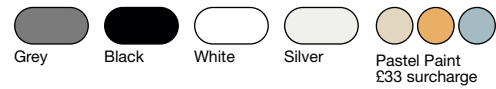

### Product Features



**NS1BS**  
1 Seater  
with Arms

Band 1 .....	£1,522
Band 2 .....	£1,562
Band 3 .....	£1,644
Band 4 .....	£1,666
Band 5 .....	£1,779
Band 6 .....	£1,851
Band 7 .....	£1,919
Leather Group 1 .....	POA



**NS2BS**  
2 Seater  
with Arms

Band 1 .....	£2,179
Band 2 .....	£2,244
Band 3 .....	£2,368
Band 4 .....	£2,477
Band 5 .....	£2,587
Band 6 .....	£2,695
Band 7 .....	£2,803
Leather Group 1 .....	POA



**NS1HS**  
1 Seater Fixed Back Cushion  
with Arms

Band 1 .....	£1,751
Band 2 .....	£1,807
Band 3 .....	£1,914
Band 4 .....	£2,004
Band 5 .....	£2,094
Band 6 .....	£2,185
Band 7 .....	£2,278
Leather Group 1 .....	POA



**NS2HS**  
2 Seater Fixed Back Cushions  
with Arms

Band 1 .....	£2,639
Band 2 .....	£2,730
Band 3 .....	£2,899
Band 4 .....	£3,046
Band 5 .....	£3,195
Band 6 .....	£3,344
Band 7 .....	£3,491
Leather Group 1 .....	POA



**NS2PBS**  
2 Seater

Band 1 .....	£2,179
Band 2 .....	£2,244
Band 3 .....	£2,368
Band 4 .....	£2,477
Band 5 .....	£2,587
Band 6 .....	£2,695
Band 7 .....	£2,803
Leather Group 1 .....	POA



**NS2PHS**  
2 Seater with Fixed Back  
Cushions

Band 1 .....	£2,639
Band 2 .....	£2,730
Band 3 .....	£2,899
Band 4 .....	£3,046
Band 5 .....	£3,195
Band 6 .....	£3,344
Band 7 .....	£3,491
Leather Group 1 .....	POA



**NS1S**  
Small Bench

Band 1 .....	£954
Band 2 .....	£981
Band 3 .....	£1,027
Band 4 .....	£1,071
Band 5 .....	£1,110
Band 6 .....	£1,152
Band 7 .....	£1,194
Leather Group 1 .....	POA



**NS2S**  
2 Seater Large Bench

Band 1 .....	£1,215
Band 2 .....	£1,255
Band 3 .....	£1,326
Band 4 .....	£1,387
Band 5 .....	£1,448
Band 6 .....	£1,509
Band 7 .....	£1,574
Leather Group 1 .....	POA



**NST069S**  
Table  
980W x 680D x 275H

Group Z .....	£577
---------------	------



**NSCP**  
Loose Plain Cushion

Band 1 .....	£131
Band 2 .....	£141
Band 3 .....	£150
Band 4 .....	£160
Band 5 .....	£168
Band 6 .....	£177
Band 7 .....	£190
Leather Group 1 .....	POA



**NSCB**  
Loose Piped and  
Buttoned Cushion

Band 1 .....	£153
Band 2 .....	£160
Band 3 .....	£171
Band 4 .....	£181
Band 5 .....	£191
Band 6 .....	£202
Band 7 .....	£209
Leather Group 1 .....	POA

5 Year  
Guarantee

## ALVIER SLED LEG SOFT SEATING, RECEPTION & BREAKOUT

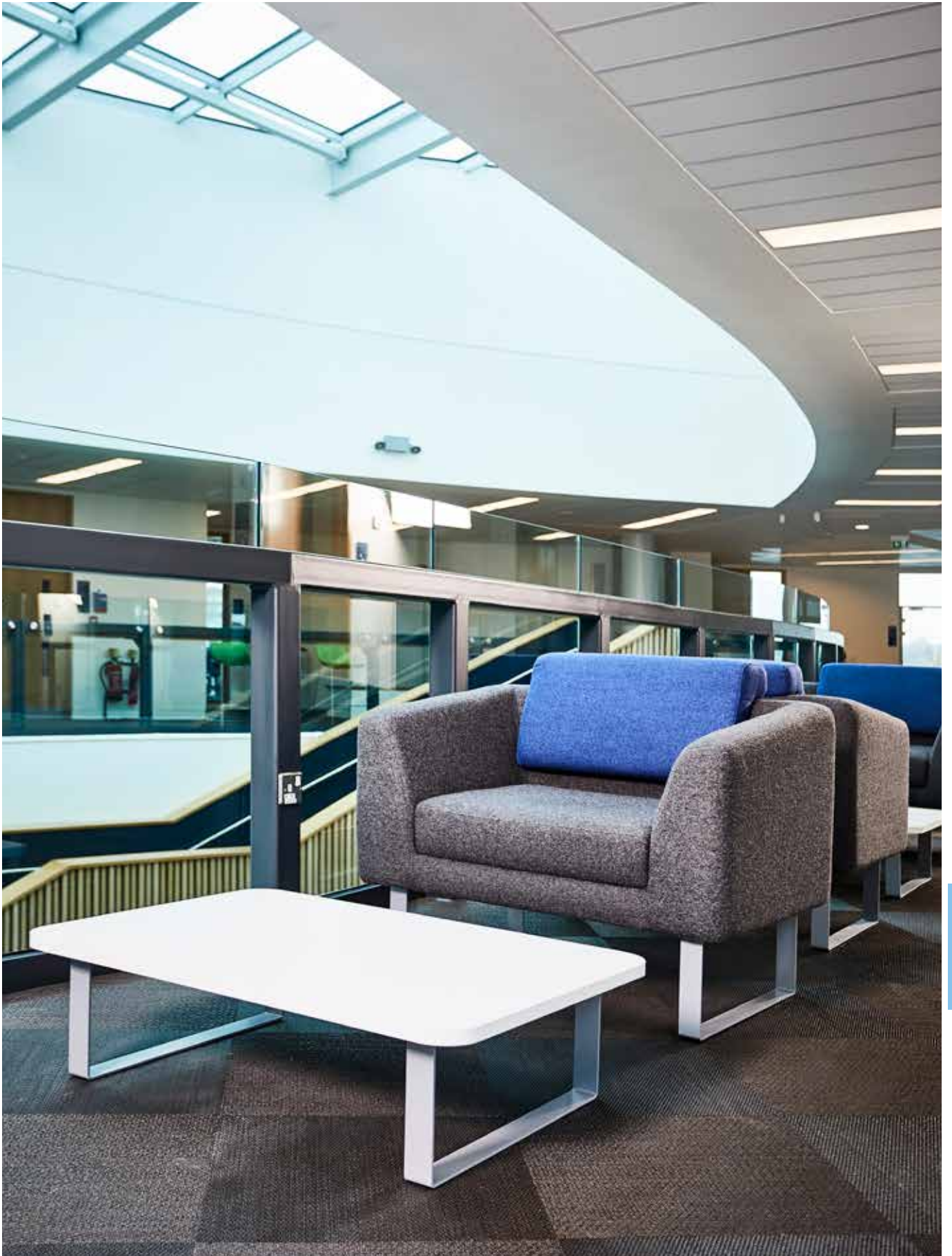

Reception,  
Breakout &  
Soft Seating

Camira X2 Number AK020 (Band 1) Outer and Camira X2 Maths AK007 (Band 1) Cushion with White Sled Leg

# ALVIER TUBE LEG

## SOFT SEATING, RECEPTION & BREAKOUT



This elegant seating collection comprises of a single and two seat sofa with bench options.

- Modern steel tube frame construction.
- Accompanying coffee tables, available in a variety of top finishes.
- Perfect collection for breakout, reception, hotel lobby or executive office environments.

### Frame Colours

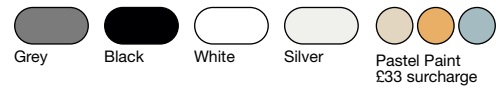

### Product Features



**NS1BM**  
1 Seater  
with Arms

Band 1 .....	£1,308
Band 2 .....	£1,353
Band 3 .....	£1,429
Band 4 .....	£1,497
Band 5 .....	£1,565
Band 6 .....	£1,636
Band 7 .....	£1,703
Leather Group 1.....	POA



**NS2BM**  
2 Seater  
with Arms

Band 1 .....	£1,962
Band 2 .....	£2,033
Band 3 .....	£2,154
Band 4 .....	£2,264
Band 5 .....	£2,373
Band 6 .....	£2,479
Band 7 .....	£2,590
Leather Group 1.....	POA



**NS1HM**  
1 Seater Fixed Back Cushion  
with Arms

Band 1 .....	£1,538
Band 2 .....	£1,591
Band 3 .....	£1,698
Band 4 .....	£1,791
Band 5 .....	£1,881
Band 6 .....	£1,971
Band 7 .....	£2,064
Leather Group 1.....	POA



**NS2HM**  
2 Seater Fixed Back Cushions  
with Arms

Band 1 .....	£2,426
Band 2 .....	£2,515
Band 3 .....	£2,685
Band 4 .....	£2,833
Band 5 .....	£2,979
Band 6 .....	£3,128
Band 7 .....	£3,277
Leather Group 1.....	POA



**NS2PBM**  
2 Seater

Band 1 .....	£1,962
Band 2 .....	£2,033
Band 3 .....	£2,154
Band 4 .....	£2,264
Band 5 .....	£2,373
Band 6 .....	£2,479
Band 7 .....	£2,590
Leather Group 1.....	POA



**NS2PHM**  
2 Seater with Fixed Back  
Cushions

Band 1 .....	£2,426
Band 2 .....	£2,515
Band 3 .....	£2,685
Band 4 .....	£2,833
Band 5 .....	£3,012
Band 6 .....	£3,128
Band 7 .....	£3,277
Leather Group 1.....	POA



**NS1M**  
Small Bench

Band 1 .....	£742
Band 2 .....	£767
Band 3 .....	£813
Band 4 .....	£855
Band 5 .....	£899
Band 6 .....	£938
Band 7 .....	£982
Leather Group 1.....	POA



**NS2M**  
2 Seater Large Bench

Band 1 .....	£1,002
Band 2 .....	£1,042
Band 3 .....	£1,110
Band 4 .....	£1,172
Band 5 .....	£1,235
Band 6 .....	£1,295
Band 7 .....	£1,359
Leather Group 1.....	POA



**NST069M**  
Table  
980w x 680d x 275h

Group Z .....	£363
---------------	------



**NSCP**  
Loose Plain Cushion

Band 1 .....	£131
Band 2 .....	£141
Band 3 .....	£150
Band 4 .....	£160
Band 5 .....	£168
Band 6 .....	£177
Band 7 .....	£190
Leather Group 1.....	POA



**NSCB**  
Loose Piped and Button  
Cushion

Band 1 .....	£153
Band 2 .....	£160
Band 3 .....	£171
Band 4 .....	£181
Band 5 .....	£191
Band 6 .....	£202
Band 7 .....	£209
Leather Group 1.....	POA

5 Year  
Guarantee

## ALVIER TUBE LEG SOFT SEATING, RECEPTION & BREAKOUT



Gabriel Atlantic 65075 (Band 3) with Silver Tube Legs

Reception,  
Breakout &  
Soft Seating

# IZZEY

## SOFT SEATING, RECEPTION & BREAKOUT

5 Year Guarantee

Redefining traditional high, winged back reading chairs, Izzey offers an inviting retreat for those seeking personal space. This armchair and sofa family is ideal for informal, discreet meetings or individual relaxation. Available with two back heights, in single and twin seat options that satisfies simple privacy requirements in open plan areas.

### Frame Colours



### Product Features



### Please Note

Available in selected fabrics only - Please contact our Sales Department for further information.



**IZH1**  
High Back Cut Out Arm 1 Seater

Band 4	£2,042
Band 5	£2,137
Band 6	£2,230
Band 7	£2,326
Leather Group 1	POA



**IZH2**  
High Back Cut Out Arm 2 Seater

Band 4	£2,982
Band 5	£3,141
Band 6	£3,295
Band 7	£3,452
Leather Group 1	POA



**IZLO1**  
Low Back Cut Out Arm 1 Seater

Band 4	£1,949
Band 5	£2,033
Band 6	£2,115
Band 7	£2,200
Leather Group 1	POA



**IZLO2**  
Low Back Cut Out Arm 2 Seater

Band 4	£2,816
Band 5	£2,964
Band 6	£3,115
Band 7	£3,261
Leather Group 1	POA



**IZH1FA**  
High Back Full Arm 1 Seater

Band 4	£2,042
Band 5	£2,137
Band 6	£2,230
Band 7	£2,326
Leather Group 1	POA



**IZH2FA**  
High Back Full Arm 2 Seater

Band 4	£2,982
Band 5	£3,141
Band 6	£3,295
Band 7	£3,452
Leather Group 1	POA



**IZLO1FA**  
Low Back Full Arm 1 Seater

Band 4	£1,949
Band 5	£2,033
Band 6	£2,115
Band 7	£2,200
Leather Group 1	POA



**IZLO2FA**  
Low Back Full Arm 2 Seater

Band 4	£2,816
Band 5	£2,964
Band 6	£3,115
Band 7	£3,261
Leather Group 1	POA

5 Year  
Guarantee

# IZZEY

SOFT SEATING, RECEPTION & BREAKOUT



Reception,  
Breakout &  
Soft Seating

Camira X2 Number AK020 (Band 1) with Natural Wooden Legs

# IZZHEY LITE

## SOFT SEATING, RECEPTION & BREAKOUT



Izhey Lite is a playfully stylish chair that coordinates with the rest of this winged backed range. Where other family members create enclosed, personal space, 'Lite' encourages users to interact with the world around them. This compact tub chair is designed for relaxed, informal gatherings where small clusters can be arranged together. Perfect for contemporary socialising.

### Product Features



### Please Note

Available in selected fabrics only - Please contact our Sales Department for further information.



**IZLT**  
Static

Band 3 .....	£1,194
Band 4 .....	£1,321
Band 5 .....	£1,448
Band 6 .....	£1,576
Band 7 .....	£1,703
Leather Group 1 .....	POA



**IZLTS**  
Swivel

Band 3 .....	£1,448
Band 4 .....	£1,576
Band 5 .....	£1,703
Band 6 .....	£1,831
Band 7 .....	£1,956
Leather Group 1 .....	POA



**IZLTW**  
Mobile

Band 3 .....	£1,252
Band 4 .....	£1,379
Band 5 .....	£1,507
Band 6 .....	£1,635
Band 7 .....	£1,760
Leather Group 1 .....	POA



5 Year  
Guarantee

# IZZHEY LITE

SOFT SEATING, RECEPTION & BREAKOUT

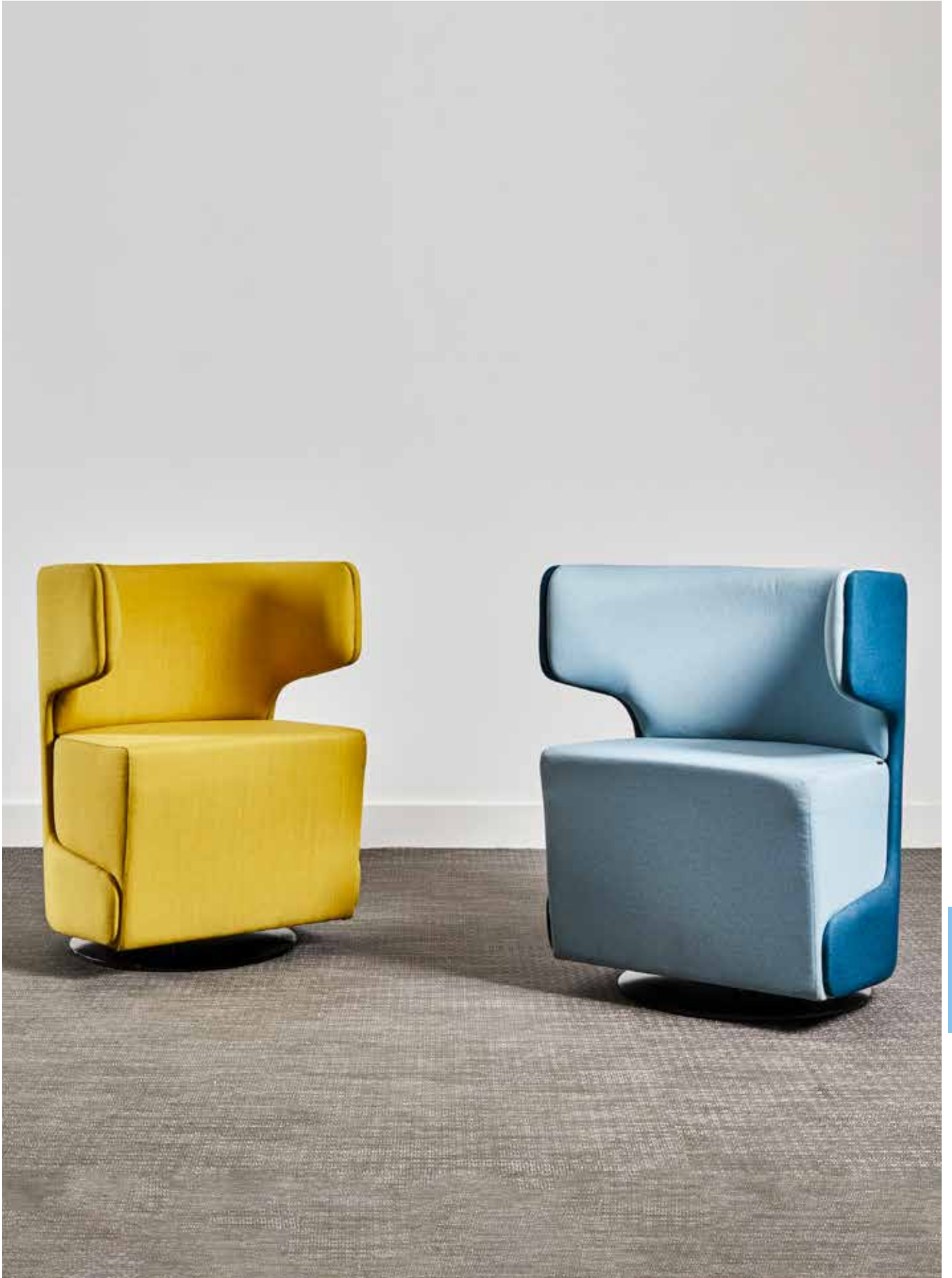

Reception,  
Breakout &  
Soft Seating

From L/R Gabriel Crisp 04211 (Band 4) and Gabriel Crisp 04751 (Band 4) Inner and Gabriel Crisp 04601 (Band 4) Outer with Swivel Base

# TIROS

## SOFT SEATING, RECEPTION & BREAKOUT



The perfect balance of form and function, our Tiros seating collection combines comfort with practicality. A cushioned back and base is complemented by the useful addition of an in-built table, just the right size for a laptop and a cup of coffee. Boasting a statement metal frame, which encases the cocoon-style seat within, the design - available in 4 variations: a high or low back single-seater and a high or low back two-seater - offering a chic solution for hospitality and workplace settings. The Tiros range is available with a Black, White, Grey or Silver Frame, and upholstered in a singular or two-tone fabric.

\*Cushions included in the price

### Product Features



### Frame Colours



### Optional Extra

Writing Tablet..... £211



**TIR1LB**  
1 Seater Low Back  
with Cushions

Band 1 .....	£1,281
Band 2 .....	£1,389
Band 3 .....	£1,539
Band 4 .....	£1,671
Band 5 .....	£1,825
Band 6 .....	£1,961
Band 7 .....	£2,097



**TIR1HB**  
1 Seater High Back  
with Cushions

Band 1 .....	£1,433
Band 2 .....	£1,558
Band 3 .....	£1,729
Band 4 .....	£1,878
Band 5 .....	£2,055
Band 6 .....	£2,211
Band 7 .....	£2,364



**TIR2LB**  
2 Seater Low Back  
with Cushions

Band 1 .....	£1,739
Band 2 .....	£1,887
Band 3 .....	£2,090
Band 4 .....	£2,267
Band 5 .....	£2,477
Band 6 .....	£2,664
Band 7 .....	£2,846



**TIR2HB**  
2 Seater High Back  
with Cushions

Band 1 .....	£1,973
Band 2 .....	£2,139
Band 3 .....	£2,369
Band 4 .....	£2,569
Band 5 .....	£2,807
Band 6 .....	£3,017
Band 7 .....	£3,222



Reception,  
Breakout &  
Soft Seating

5 Year  
Guarantee

NEW  
PRODUCT

# TIROS

SOFT SEATING, RECEPTION & BREAKOUT



Reception,  
Breakout &  
Soft Seating

# OSANA BENCH

## SOFT SEATING, RECEPTION & BREAKOUT



A modern twist on classic aesthetics, our Osana Bench was created for collaboration. Equally, with some tweaks to its configuration, space can be made for solo work, relaxation or contemplation. Thanks to a sleek, understated design, Osana works well in workplace, residential and hospitality settings due to its ability to seamlessly complement its surroundings. Choose from either a Natural Oak or Dark Walnut finish for the frame, dialling up, or paring back on the statement.

### Product Features



### Frame Colours



Natural Ash



Dark Walnut



KB1SF  
1 Seater Wooden Base

£358



KB2SF  
2 Seater Wooden Base

£462



KB3SF  
3 Seater Wooden Base

£550

KBBKT  
Linking Bracket

£40





# OSANA BENCH

## SOFT SEATING, RECEPTION & BREAKOUT



**KBCS**  
Seat with Arm and Back

Band 1 .....	£760
Band 2 .....	£802
Band 3 .....	£861
Band 4 .....	£913
Band 5 .....	£972
Band 6 .....	£1,027
Band 7 .....	£1,079



**KBSS**  
Seat with Back

Band 1 .....	£666
Band 2 .....	£701
Band 3 .....	£751
Band 4 .....	£794
Band 5 .....	£845
Band 6 .....	£890
Band 7 .....	£934



**KBPC**  
Seat Pad

Band 1 .....	£493
Band 2 .....	£513
Band 3 .....	£543
Band 4 .....	£568
Band 5 .....	£598
Band 6 .....	£625
Band 7 .....	£652



**KBTS**  
Table Top

£140



Reception,  
Breakout &  
Soft Seating

# UNOA BOOTH

## SOFT SEATING, RECEPTION & BREAKOUT



As the needs of the workplace have evolved over the last two-years, we, in turn, have adapted our product offering to include pieces such as the Unoa Booth. Allowing for small meetings to take place in a comfortable yet private setting, Unoa's acoustic properties are unparalleled for a solution of its size. The design also allows for inclusion of a monitor\* for supporting presentations and video calls, which, thanks to the optimal acoustics of the booth, can be carried out with minimal disturbance to those working nearby. Choose from either a Natural Ash or Dark Walnut finish for Unoa's frame.

### Product Features



### Frame Colours



Natural Ash



Dark Walnut

\*Monitor not included



**UNOBA1**  
Half Booth without Table  
Standard Upholstery

Band 1 .....	£2,629
Band 2 .....	£2,754
Band 3 .....	£2,926
Band 4 .....	£3,078
Band 5 .....	£3,255
Band 6 .....	£3,413
Band 7 .....	£3,568



**UNOBA2**  
Full Booth with Table  
Standard Upholstery

Band 1 .....	£7,204
Band 2 .....	£7,523
Band 3 .....	£7,961
Band 4 .....	£8,347
Band 5 .....	£8,800
Band 6 .....	£9,202
Band 7 .....	£9,597



5 Year  
Guarantee

NEW  
PRODUCT

# UNOA BOOTH

SOFT SEATING, RECEPTION & BREAKOUT



Reception,  
Breakout &  
Soft Seating

# TAKE UP

## SOFT SEATING, RECEPTION & BREAKOUT

5 Year  
Guarantee

Create your own environment with this acoustic, high-backed sofa system.

- Perfect whether needing privacy, wanting to socialise or function within a considered environment.
- Available in three height options, with and without arms.
- Associated tables and integrated technology available, Take Up works with you.

### Product Features



### Additional Information

Due to the nature of this product we advise use of fabrics from Band 3 and above (Please contact our sales department for further information) Table Tops available in all standard GOF MFC finishes. Integrated technology available.

### Foot



Black  
Glide





# TAKE UP SOFT SEATING, RECEPTION & BREAKOUT



**TKUMD**  
2 Tier  
with Arms

Band 3 .....	£2,641
Band 4 .....	£2,805
Band 5 .....	£2,967
Band 6 .....	£3,129
Band 7 .....	£3,291
Leather Group 1 .....	POA



**TKUML**  
2 Tier  
with Left Arm

Band 3 .....	£2,164
Band 4 .....	£2,296
Band 5 .....	£2,431
Band 6 .....	£2,562
Band 7 .....	£2,696
Leather Group 1 .....	POA



**TKUMR**  
2 Tier  
with Right Arm

Band 3 .....	£2,164
Band 4 .....	£2,296
Band 5 .....	£2,431
Band 6 .....	£2,562
Band 7 .....	£2,696
Leather Group 1 .....	POA



**TKUMS**  
2 Tier  
without Arms

Band 3 .....	£1,597
Band 4 .....	£1,693
Band 5 .....	£1,784
Band 6 .....	£1,873
Band 7 .....	£1,985
Leather Group 1 .....	POA



**TKUMST**  
2 Tier  
with Table

Band 3 .....	£1,597
Band 4 .....	£1,693
Band 5 .....	£1,784
Band 6 .....	£1,873
Band 7 .....	£1,985
Leather Group 1 .....	POA



**TKUMCA**  
2 Tier Corner

Band 3 .....	£3,026
Band 4 .....	£3,169
Band 5 .....	£3,309
Band 6 .....	£3,449
Band 7 .....	£3,585
Leather Group 1 .....	POA



**TKUMCTA**  
2 Tier Corner  
with Table

Band 3 .....	£3,026
Band 4 .....	£3,169
Band 5 .....	£3,309
Band 6 .....	£3,449
Band 7 .....	£3,585
Leather Group 1 .....	POA



**TKUSD**  
Low Arm  
with Arms

Band 3 .....	£2,470
Band 4 .....	£2,623
Band 5 .....	£2,775
Band 6 .....	£2,929
Band 7 .....	£3,082
Leather Group 1 .....	POA



**TKUSL**  
Low Arm  
with Left Arm

Band 3 .....	£2,002
Band 4 .....	£2,116
Band 5 .....	£2,229
Band 6 .....	£2,341
Band 7 .....	£2,457
Leather Group 1 .....	POA



**TKUSR**  
Low Arm  
with Right Arm

Band 3 .....	£2,002
Band 4 .....	£2,116
Band 5 .....	£2,229
Band 6 .....	£2,341
Band 7 .....	£2,457
Leather Group 1 .....	POA



**TKUFD**  
Single Tier  
with Arms

Band 3 .....	£2,426
Band 4 .....	£2,603
Band 5 .....	£2,778
Band 6 .....	£2,953
Band 7 .....	£3,130
Leather Group 1 .....	POA



**TKUFL**  
Single Tier  
with Left Arm

Band 3 .....	£1,924
Band 4 .....	£2,059
Band 5 .....	£2,194
Band 6 .....	£2,329
Band 7 .....	£2,464
Leather Group 1 .....	POA



**TKUFR**  
Single Tier  
with Right Arm

Band 3 .....	£1,924
Band 4 .....	£2,059
Band 5 .....	£2,194
Band 6 .....	£2,329
Band 7 .....	£2,464
Leather Group 1 .....	POA



**TKUFS**  
Single Tier  
without Arms

Band 3 .....	£1,450
Band 4 .....	£1,544
Band 5 .....	£1,636
Band 6 .....	£1,729
Band 7 .....	£1,822
Leather Group 1 .....	POA



**TKUFST**  
Single Tier  
with Table

Band 3 .....	£1,450
Band 4 .....	£1,544
Band 5 .....	£1,636
Band 6 .....	£1,729
Band 7 .....	£1,822
Leather Group 1 .....	POA



**TKUFCA**  
Single Tier Corner

Band 3 .....	£2,664
Band 4 .....	£2,811
Band 5 .....	£2,956
Band 6 .....	£3,104
Band 7 .....	£3,250
Leather Group 1 .....	POA



**TKUFCTA**  
Single Tier Corner  
with Table

Band 3 .....	£2,664
Band 4 .....	£2,811
Band 5 .....	£2,956
Band 6 .....	£3,104
Band 7 .....	£3,250
Leather Group 1 .....	POA

# TAKE UP

## SOFT SEATING, RECEPTION & BREAKOUT



**TKULD**  
3 Tier with Arms

Band 3 .....	£3,147
Band 4 .....	£3,373
Band 5 .....	£3,602
Band 6 .....	£3,829
Band 7 .....	£4,054
Leather Group 1 .....	POA



**TKULL**  
3 Tier with Left Arm

Band 3 .....	£2,540
Band 4 .....	£2,704
Band 5 .....	£2,870
Band 6 .....	£3,036
Band 7 .....	£3,201
Leather Group 1 .....	POA



**TKULR**  
3 Tier with Right Arm

Band 3 .....	£2,540
Band 4 .....	£2,704
Band 5 .....	£2,870
Band 6 .....	£3,036
Band 7 .....	£3,201
Leather Group 1 .....	POA



**TKULS**  
3 Tier without Arms

Band 3 .....	£1,795
Band 4 .....	£1,903
Band 5 .....	£2,014
Band 6 .....	£2,121
Band 7 .....	£2,230
Leather Group 1 .....	POA



**TKULST**  
3 Tier with Table

Band 3 .....	£1,795
Band 4 .....	£1,903
Band 5 .....	£2,014
Band 6 .....	£2,121
Band 7 .....	£2,230
Leather Group 1 .....	POA



**TKULCA**  
3 Tier Corner

Band 3 .....	£3,377
Band 4 .....	£3,539
Band 5 .....	£3,694
Band 6 .....	£3,860
Band 7 .....	£4,020
Leather Group 1 .....	POA



**TKULCTA**  
3 Tier Corner with Table

Band 3 .....	£3,377
Band 4 .....	£3,539
Band 5 .....	£3,694
Band 6 .....	£3,860
Band 7 .....	£4,020
Leather Group 1 .....	POA



Reception,  
Breakout &  
Soft Seating

Camira Blazer Silcoates CUZ30 (Band 4) Tier 1 and Outer with Camira Blazer Dunhurst CUZ58 (Band 4) Tier 2

# TAKE UP SOFT SEATING, RECEPTION & BREAKOUT



**TKUSCA**  
Scatter Cushion

Band 3 .....	£115
Band 4 .....	£132
Band 5 .....	£150
Band 6 .....	£167
Band 7 .....	£183
Leather Group 1 .....	POA



**TKUCUS**  
Divider Arm

Band 3 .....	£284
Band 4 .....	£310
Band 5 .....	£334
Band 6 .....	£360
Band 7 .....	£380
Leather Group 1 .....	POA



**TKUTOP**  
Divider table

Price .....	£177
-------------	------



**TKU55**  
Single

Band 3 .....	£504
Band 4 .....	£550
Band 5 .....	£598
Band 6 .....	£648
Band 7 .....	£691
Leather Group 1 .....	POA



**TKU58**  
Large Single

Band 3 .....	£983
Band 4 .....	£1,043
Band 5 .....	£1,104
Band 6 .....	£1,160
Band 7 .....	£1,220
Leather Group 1 .....	POA



**TKU58T**  
Large Single Table

Band 3 .....	£983
Band 4 .....	£1,043
Band 5 .....	£1,104
Band 6 .....	£1,160
Band 7 .....	£1,220
Leather Group 1 .....	POA



**TKU516**  
Double

Band 3 .....	£1,400
Band 4 .....	£1,499
Band 5 .....	£1,597
Band 6 .....	£1,698
Band 7 .....	£1,796
Leather Group 1 .....	POA



**TKU516T**  
Large Double Table

Band 3 .....	£1,400
Band 4 .....	£1,499
Band 5 .....	£1,597
Band 6 .....	£1,698
Band 7 .....	£1,796
Leather Group 1 .....	POA



Camira Blazer Barnard CUZ2S (Band 4) Tier 1 and Outer with Camira Blazer Dartmouth CUZ2Q (Band 4) Tier 2

# TAKE UP BOOTH

## SOFT SEATING, RECEPTION & BREAKOUT



A variation of our high-back Take Up sofa system.

- Perfect for creating privacy and where audio visual communication may be required.
- Available for two or four users and in three height options.
- Associated table available with 25mm MFC top panel.

TV or Monitors are not included.

### Optional Extras

**TKBB** Optional TV / Monitor Bracket £303  
For fitting to 1600 high and 1200 high connector walls.  
Can support up to 42" monitors (not supplied)

### Additional Information

Due to the nature of this product we advise use of fabrics from Band 3 and above. We recommend that you request fabric samples prior to ordering. Two Tone Upholstery is available at a surcharge. Table Tops available in all standard GOF MFC finishes.

### Product Features

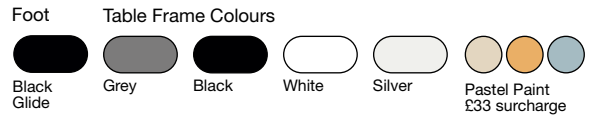

**TKBL084**  
4 user, 3 tier, 1600mm high

Band 3 .....	£14,046
Band 4 .....	£15,153
Band 5 .....	£15,890
Band 6 .....	£16,630
Band 7 .....	£17,366
Leather Group 1.....	POA



**TKBL082**  
2 user, 3 tier, 1600mm high

Band 3 .....	£8,968
Band 4 .....	£9,741
Band 5 .....	£10,150
Band 6 .....	£10,555
Band 7 .....	£10,965
Leather Group 1.....	POA



**TKBL084T**  
4 user, 3 tier, 1600mm high  
with table

Band 3 .....	£14,589
Band 4 .....	£15,695
Band 5 .....	£16,431
Band 6 .....	£17,170
Band 7 .....	£17,905
Leather Group 1.....	POA



**TKBL082T**  
2 user, 3 tier, 1600mm high  
with table

Band 3 .....	£9,449
Band 4 .....	£10,223
Band 5 .....	£10,632
Band 6 .....	£11,036
Band 7 .....	£11,444
Leather Group 1.....	POA



**TKBM084**  
4 user, 2 tier, 1200mm high

Band 3 .....	£11,648
Band 4 .....	£12,568
Band 5 .....	£13,178
Band 6 .....	£13,792
Band 7 .....	£14,405
Leather Group 1.....	POA



**TKBM082**  
2 user, 2 tier, 1200mm high

Band 3 .....	£7,323
Band 4 .....	£7,972
Band 5 .....	£8,322
Band 6 .....	£8,667
Band 7 .....	£9,014
Leather Group 1.....	POA



**TKBM084T**  
4 user, 2 tier, 1200mm high  
with table

Band 3 .....	£12,189
Band 4 .....	£13,110
Band 5 .....	£13,722
Band 6 .....	£14,334
Band 7 .....	£14,947
Leather Group 1.....	POA



**TKBM082T**  
2 user, 2 tier, 1200mm high  
with table

Band 3 .....	£7,805
Band 4 .....	£8,454
Band 5 .....	£8,803
Band 6 .....	£9,147
Band 7 .....	£9,493
Leather Group 1.....	POA

5 Year  
Guarantee

## TAKE UP BOOTH

SOFT SEATING, RECEPTION & BREAKOUT

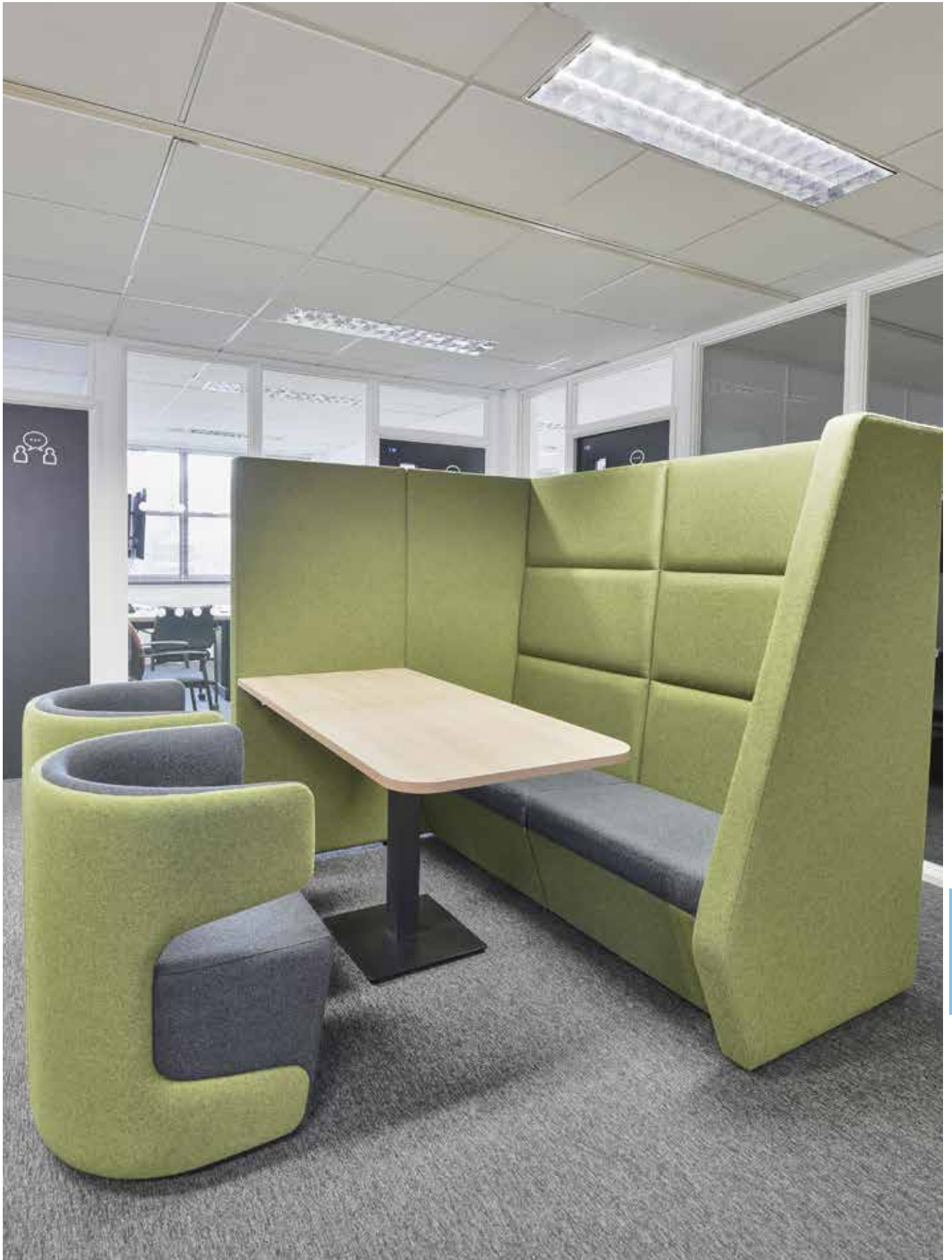

Reception,  
Breakout &  
Soft Seating

Camira (Band 4) Outer with Camira Blazer Camphill CUZ1K Seat Bromsgrove CUZ35

# TAKE UP BOOTH

## SOFT SEATING, RECEPTION & BREAKOUT



**TKBL082TR**  
2 user, 3 tier, 1600mm high  
with table (right hand)

Band 3 .....	£9,788
Band 4 .....	£10,285
Band 5 .....	£10,695
Band 6 .....	£11,100
Band 7 .....	£11,507
Leather Group 1 .....	POA



**TKBL082TL**  
2 user, 3 tier, 1600mm high  
with table (left hand)

Band 3 .....	£9,788
Band 4 .....	£10,285
Band 5 .....	£10,695
Band 6 .....	£11,100
Band 7 .....	£11,507
Leather Group 1 .....	POA



**TKBL081TR**  
1 user, 3 tier, 1600mm high  
with table (right hand)

Band 3 .....	£6,908
Band 4 .....	£7,517
Band 5 .....	£7,761
Band 6 .....	£8,000
Band 7 .....	£8,246
Leather Group 1 .....	POA



**TKBL081TL**  
1 user, 3 tier, 1600mm high  
with table (left hand)

Band 3 .....	£6,908
Band 4 .....	£7,517
Band 5 .....	£7,761
Band 6 .....	£8,000
Band 7 .....	£8,246
Leather Group 1 .....	POA



**TKBM082TR**  
2 user, 2 tier, 1200mm high  
with table (right hand)

Band 3 .....	£7,864
Band 4 .....	£8,516
Band 5 .....	£8,863
Band 6 .....	£9,211
Band 7 .....	£9,556
Leather Group 1 .....	POA



**TKBM082TL**  
2 user, 2 tier, 1200mm high  
with table (left hand)

Band 3 .....	£7,864
Band 4 .....	£8,516
Band 5 .....	£8,863
Band 6 .....	£9,211
Band 7 .....	£9,556
Leather Group 1 .....	POA



**TKBM081TR**  
1 user, 2 tier, 1200mm high  
with table (right hand)

Band 3 .....	£5,642
Band 4 .....	£6,159
Band 5 .....	£6,374
Band 6 .....	£6,583
Band 7 .....	£6,796
Leather Group 1 .....	POA



**TKBM081TL**  
1 user, 2 tier, 1200mm high  
with table (left hand)

Band 3 .....	£5,642
Band 4 .....	£6,159
Band 5 .....	£6,374
Band 6 .....	£6,583
Band 7 .....	£6,796
Leather Group 1 .....	POA



Reception,  
Breakout &  
Soft Seating

Camira Blazer Silcoates CUZ30 (Band 4) Tier 1 and Outer with Camira Blazer Dunhurst CUZ58 (Band 4) Tier 2 and 3

## TAKE UP BOOTH

SOFT SEATING, RECEPTION & BREAKOUT



Camira (Band 3) Outer with Camira Synergy Engage LDS57 Seat Support LDS55 with White Framed White MFC Table

# TAKE OFF

## SOFT SEATING, RECEPTION & BREAKOUT



Take Off is a modular sofa system that can be used in reception or open plan work spaces where users need a 'time-out'.

- Available with and without backs or arms.
- Can be configured to delineate mid floor or perimeter space.
- Easily maintained upholstery and robust frame makes it ideal for heavy traffic areas.

### Frame Colours

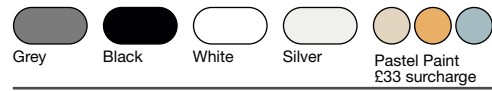

### Product Features



### Additional Information

Table Tops available in all standard GOF MFC finishes.



**AS06LBA**  
Half Back with Left Arm

Band 1	£1,880
Band 2	£1,950
Band 3	£2,074
Band 4	£2,185
Band 5	£2,295
Band 6	£2,406
Band 7	£2,515
Leather Group 1	.POA



**AS06RBA**  
Half Back with Right Arm

Band 1	£1,880
Band 2	£1,950
Band 3	£2,074
Band 4	£2,185
Band 5	£2,295
Band 6	£2,406
Band 7	£2,515
Leather Group 1	.POA



**AS06FLA**  
Full Back with Left Arm

Band 1	£2,150
Band 2	£2,223
Band 3	£2,346
Band 4	£2,459
Band 5	£2,603
Band 6	£2,683
Band 7	£2,790
Leather Group 1	.POA



**AS06FRA**  
Full Back with Right Arm

Band 1	£2,150
Band 2	£2,223
Band 3	£2,346
Band 4	£2,459
Band 5	£2,603
Band 6	£2,683
Band 7	£2,790
Leather Group 1	.POA



**AS06FA**  
Full Back with Arms

Band 1	£2,443
Band 2	£2,533
Band 3	£2,694
Band 4	£2,836
Band 5	£2,978
Band 6	£3,122
Band 7	£3,264
Leather Group 1	.POA



**AS06TB**  
2 Seater Twin Back

Band 1	£1,938
Band 2	£2,005
Band 3	£2,125
Band 4	£2,230
Band 5	£2,335
Band 6	£2,442
Band 7	£2,547
Leather Group 1	.POA



**AS06LB**  
2 Seater Half Back L/H

Band 1	£1,589
Band 2	£1,634
Band 3	£1,713
Band 4	£1,788
Band 5	£1,856
Band 6	£1,929
Band 7	£2,002
Leather Group 1	.POA

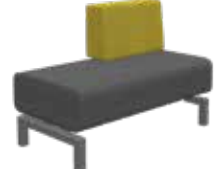

**AS06RB**  
2 Seater Half Back R/H

Band 1	£1,589
Band 2	£1,634
Band 3	£1,713
Band 4	£1,788
Band 5	£1,856
Band 6	£1,929
Band 7	£2,002
Leather Group 1	.POA



**AS06FB**  
Full Back 2 Seater

Band 1	£1,859
Band 2	£1,917
Band 3	£2,014
Band 4	£2,098
Band 5	£2,185
Band 6	£2,271
Band 7	£2,357
Leather Group 1	.POA



**AS66FB**  
Full Back Single Seater

Band 1	£1,146
Band 2	£1,175
Band 3	£1,232
Band 4	£1,280
Band 5	£1,330
Band 6	£1,382
Band 7	£1,430
Leather Group 1	.POA



**AS06**  
2 Seater without Back

Band 1	£1,042
Band 2	£1,062
Band 3	£1,106
Band 4	£1,142
Band 5	£1,180
Band 6	£1,215
Band 7	£1,253
Leather Group 1	.POA



**AS66**  
Single Seater without Back

Band 1	£762
Band 2	£777
Band 3	£812
Band 4	£842
Band 5	£872
Band 6	£901
Band 7	£931
Leather Group 1	.POA

Reception, Breakout & Soft Seating



5 Year  
Guarantee

# TAKE OFF SOFT SEATING, RECEPTION & BREAKOUT



**ASQ**  
Quadrant Seater without Back  
Band 1 .....£996  
Band 2 .....£1,018  
Band 3 .....£1,059  
Band 4 .....£1,096  
Band 5 .....£1,134  
Band 6 .....£1,170  
Band 7 .....£1,208  
Leather Group 1 .....POA



**A1206Z**  
Rectangular  
£679



**A1212Z**  
Large Square  
£780



**A0606Z**  
Small Square  
£514



**ATQZ**  
Quadrant  
£592



**ATRZ**  
Radial  
£693



Svensson VY 8200 (Band 6) (Grey Back) and Svensson Soft/Mill 8124 (Band 7) (Grey Seat) with Svensson VY 6636 (Band 6) (Yellow Seat) with Black Frame

Reception,  
Breakout &  
Soft Seating

# TAKE OFF PLUS LOW BACK

## SOFT SEATING, RECEPTION & BREAKOUT

5 Year Guarantee

Take Off Plus is an extension to our popular Take Off sofa system with the addition of stylised surrounds, integrated tables and technology.

Upholstered surrounds are available in two heights allowing Take Off Plus to blend collaborative working hubs with breakout spaces or quiet, concentration areas - making this distinctive family ideal for the modern workplace landscape where space is at a premium and multi-functionality is key.

The lower backed models are designed to coordinate with the higher models or for use on their own. These modules can be used equally effectively in open planned clusters, around the perimeter of a room or individually placed. The lower surrounds provide users with a feeling of security whilst allowing specifiers to inject two-toned colour options into their workspace.

### Frame Options



Sled Frame  
Suffix Code -K

### Metal Colours

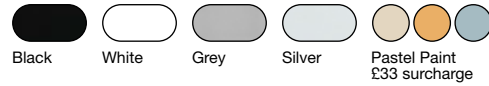

Camira X2 Subtract AK013 (Band 1) with Black Sled Frame

# TAKE OFF PLUS LOW BACK SOFT SEATING, RECEPTION & BREAKOUT



**TP3SL**  
1 Seater  
Low Surround

Band 1 .....	£2,310
Band 2 .....	£2,410
Band 3 .....	£2,558
Band 4 .....	£2,692
Band 5 .....	£2,838
Band 6 .....	£2,972
Band 7 .....	£3,101



**TP3L**  
2 Seater  
Low Surround

Band 1 .....	£3,320
Band 2 .....	£3,502
Band 3 .....	£3,769
Band 4 .....	£4,010
Band 5 .....	£4,276
Band 6 .....	£4,515
Band 7 .....	£4,751

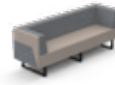

**TP11L**  
3 Seater  
Low Surround

Band 1 .....	£3,791
Band 2 .....	£4,114
Band 3 .....	£4,590
Band 4 .....	£5,025
Band 5 .....	£5,502
Band 6 .....	£5,933
Band 7 .....	£6,359

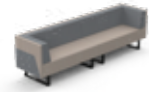

**TP4L**  
4 Seater  
Low Surround

Band 1 .....	£4,703
Band 2 .....	£5,039
Band 3 .....	£5,536
Band 4 .....	£5,984
Band 5 .....	£6,485
Band 6 .....	£6,928
Band 7 .....	£7,374

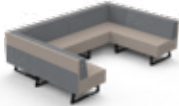

**TP1L**  
Small Open Sym.  
Low Surround

Band 1 .....	£8,855
Band 2 .....	£9,439
Band 3 .....	£10,308
Band 4 .....	£11,098
Band 5 .....	£11,969
Band 6 .....	£12,747
Band 7 .....	£13,527

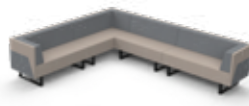

**TP2LL**  
Large Corner L/H  
Low Surround

Band 1 .....	£9,159
Band 2 .....	£9,796
Band 3 .....	£10,747
Band 4 .....	£11,609
Band 5 .....	£12,560
Band 6 .....	£13,410
Band 7 .....	£14,261

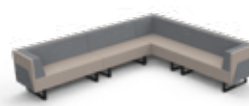

**TP2LR**  
Large Corner R/H  
Low Surround

Band 1 .....	£9,159
Band 2 .....	£9,796
Band 3 .....	£10,747
Band 4 .....	£11,609
Band 5 .....	£12,560
Band 6 .....	£13,410
Band 7 .....	£14,261



**TP8L**  
Large Sym.  
Low Surround

Band 1 .....	£13,614
Band 2 .....	£14,556
Band 3 .....	£15,959
Band 4 .....	£17,229
Band 5 .....	£18,636
Band 6 .....	£19,891
Band 7 .....	£21,146

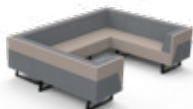

**TP5L**  
Small Sym.  
Low Surround

Band 1 .....	£9,408
Band 2 .....	£10,075
Band 3 .....	£11,071
Band 4 .....	£11,970
Band 5 .....	£12,967
Band 6 .....	£13,857
Band 7 .....	£14,748

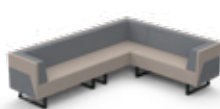

**TP6LL**  
Small Corner L/H  
Low Surround

Band 1 .....	£7,056
Band 2 .....	£7,557
Band 3 .....	£8,305
Band 4 .....	£8,977
Band 5 .....	£9,726
Band 6 .....	£10,394
Band 7 .....	£11,060

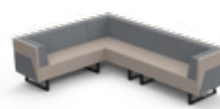

**TP6LR**  
Small Corner R/H  
Low Surround

Band 1 .....	£7,056
Band 2 .....	£7,557
Band 3 .....	£8,305
Band 4 .....	£8,977
Band 5 .....	£9,726
Band 6 .....	£10,394
Band 7 .....	£11,060



**TP92TL**  
2 Seater with Table  
Low Surround

Band 1 .....	£6,281
Band 2 .....	£6,521
Band 3 .....	£6,798
Band 4 .....	£7,138
Band 5 .....	£7,426
Band 6 .....	£7,808
Band 7 .....	£8,191



**TP7TL**  
4 Seater with Table  
Low Surround

Band 1 .....	£7,591
Band 2 .....	£7,952
Band 3 .....	£8,490
Band 4 .....	£8,977
Band 5 .....	£9,518
Band 6 .....	£9,999
Band 7 .....	£10,480



**TP106TL**  
6 Seater with Table  
Low Surround

Band 1 .....	£8,737
Band 2 .....	£9,475
Band 3 .....	£10,575
Band 4 .....	£11,569
Band 5 .....	£12,667
Band 6 .....	£13,653
Band 7 .....	£14,636

# TAKE OFF PLUS HIGH BACK

## SOFT SEATING, RECEPTION & BREAKOUT



Take Off Plus is an extension to our popular Take Off sofa system with the addition of stylised surrounds, integrated tables and technology.

Upholstered surrounds are available in two heights allowing Take Off Plus to blend collaborative working hubs with breakout spaces or quiet, concentration areas - making this distinctive family ideal for the modern workplace landscape where space is at a premium and multi-functionality is key.

The taller backed models within this family are set to the ideal height to offer privacy for users whilst allowing those around to see whether pods are occupied or not. They provide acoustic dampening when socialising or holding meetings in open-planned areas, without restricting existing lighting or air circulation within the room in which they are installed.

Take Off Plus Media Units have intergrated cable access behind TV mount and below table height.

### Frame Options

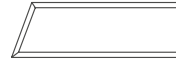

Sled Frame  
Suffix Code -K

### Metal Colours

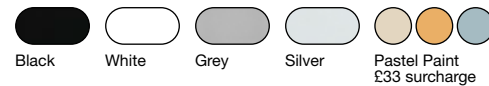

TP3SH  
1 Seater  
High Surround

Band 1 .....	£3,147
Band 2 .....	£3,329
Band 3 .....	£3,604
Band 4 .....	£3,850
Band 5 .....	£4,123
Band 6 .....	£4,367
Band 7 .....	£4,614



TP3H  
2 Seater  
High Surround

Band 1 .....	£3,810
Band 2 .....	£4,058
Band 3 .....	£4,429
Band 4 .....	£4,764
Band 5 .....	£5,134
Band 6 .....	£5,467
Band 7 .....	£5,796



TP11H  
3 Seater  
High Surround

Band 1 .....	£4,711
Band 2 .....	£5,060
Band 3 .....	£5,580
Band 4 .....	£6,047
Band 5 .....	£6,566
Band 6 .....	£7,031
Band 7 .....	£7,495

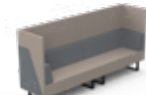

TP4H  
4 Seater  
High Surround

Band 1 .....	£5,415
Band 2 .....	£5,777
Band 3 .....	£6,316
Band 4 .....	£6,803
Band 5 .....	£7,343
Band 6 .....	£7,826
Band 7 .....	£8,308



High Back with White Sled Frame

# TAKE OFF PLUS HIGH BACK SOFT SEATING, RECEPTION & BREAKOUT

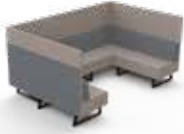

**TP1H**  
Small Open Sym.  
High Surround

Band 1 .....	£10,005
Band 2 .....	£10,637
Band 3 .....	£11,580
Band 4 .....	£12,433
Band 5 .....	£13,375
Band 6 .....	£14,218
Band 7 .....	£15,060



**TP2HL**  
Large Corner L/H  
High Surround

Band 1 .....	£10,325
Band 2 .....	£11,018
Band 3 .....	£12,052
Band 4 .....	£12,987
Band 5 .....	£14,021
Band 6 .....	£14,946
Band 7 .....	£15,870



**TP2HR**  
Large Corner R/H  
High Surround

Band 1 .....	£10,325
Band 2 .....	£11,018
Band 3 .....	£12,052
Band 4 .....	£12,987
Band 5 .....	£14,021
Band 6 .....	£14,946
Band 7 .....	£15,870

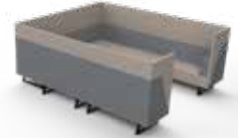

**TP8H**  
Large Sym.  
High Surround

Band 1 .....	£15,375
Band 2 .....	£16,396
Band 3 .....	£17,919
Band 4 .....	£19,298
Band 5 .....	£20,820
Band 6 .....	£22,184
Band 7 .....	£23,545

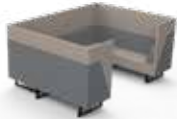

**TP5H**  
Small Sym.  
High Surround

Band 1 .....	£10,579
Band 2 .....	£11,301
Band 3 .....	£12,379
Band 4 .....	£13,355
Band 5 .....	£14,434
Band 6 .....	£15,399
Band 7 .....	£16,365

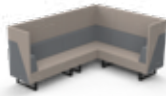

**TP6HL**  
Small Corner L/H  
High Surround

Band 1 .....	£7,926
Band 2 .....	£8,469
Band 3 .....	£9,277
Band 4 .....	£10,008
Band 5 .....	£10,817
Band 6 .....	£11,541
Band 7 .....	£12,264

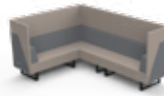

**TP6HR**  
Small Corner R/H  
High Surround

Band 1 .....	£7,926
Band 2 .....	£8,469
Band 3 .....	£9,277
Band 4 .....	£10,008
Band 5 .....	£10,817
Band 6 .....	£11,541
Band 7 .....	£12,264



**TP92TH**  
2 Seater with Table  
High Surround

Band 1 .....	£7,745
Band 2 .....	£8,196
Band 3 .....	£8,719
Band 4 .....	£9,353
Band 5 .....	£9,897
Band 6 .....	£11
Band 7 .....	£11,330



**TP7TH**  
4 Seater with Table  
High Surround

Band 1 .....	£10,459
Band 2 .....	£11,016
Band 3 .....	£11,846
Band 4 .....	£12,596
Band 5 .....	£13,425
Band 6 .....	£14,166
Band 7 .....	£14,908



**TP106TH**  
6 Seater with Table  
High Surround

Band 1 .....	£12,864
Band 2 .....	£13,655
Band 3 .....	£14,834
Band 4 .....	£15,901
Band 5 .....	£17,082
Band 6 .....	£18,136
Band 7 .....	£19,190



**TP92TMH**  
2 Seater Media Unit  
High Surround

Band 1 .....	£7,862
Band 2 .....	£8,313
Band 3 .....	£8,836
Band 4 .....	£9,471
Band 5 .....	£10
Band 6 .....	£10,730



**TP94TMH**  
4 Seater Media Unit  
High Surround

Band 7 .....	£11,447
Band 1 .....	£10,799
Band 2 .....	£11,332
Band 3 .....	£12,129
Band 4 .....	£12,852
Band 5 .....	£13,649
Band 6 .....	£14,364



**TP96TMH**  
6 Seater Media Unit  
High Surround

Band 7 .....	£15,076
--------------	---------

Band 1 .....	£12,999
Band 2 .....	£13,788
Band 3 .....	£14,968
Band 4 .....	£16,036
Band 5 .....	£17,218
Band 6 .....	£18,270
Band 7 .....	£19,325

# TAKE OFF LITE

## SOFT SEATING, RECEPTION & BREAKOUT



Take-Off Lite is a modular upholstered sofa system that can be used to delineate mid floor or perimeter spaces in those 'away-from-desk' areas, making it great for busy workplaces or public use.

Its seat and back can be matched, or complemented to provide additional visual interest, whilst Take-Off Lite's light-weight skid frame provides simple elegance whilst allowing modules to be easily configured to the desired layout.

Modules are available with or without backs, in single or twin seat options. Each unit can be matched to each other in any combination or used individually providing flexibility for your working landscape.

### Frame Colours

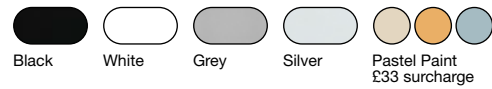

**TL06**  
Single Seater with No Back

Band 1 .....	£492
Band 2 .....	£513
Band 3 .....	£543
Band 4 .....	£574
Band 5 .....	£606
Band 6 .....	£635
Band 7 .....	£664



**TL06FB**  
Single Seater with Full Back

Band 1 .....	£653
Band 2 .....	£690
Band 3 .....	£742
Band 4 .....	£790
Band 5 .....	£842
Band 6 .....	£893
Band 7 .....	£938



**TL12**  
2 Seater with No Back

Band 1 .....	£706
Band 2 .....	£734
Band 3 .....	£772
Band 4 .....	£810
Band 5 .....	£852
Band 6 .....	£887
Band 7 .....	£923



**TL12RB**  
2 Seater with Right Hand Back

Band 1 .....	£862
Band 2 .....	£922
Band 3 .....	£1,008
Band 4 .....	£1,088
Band 5 .....	£1,176
Band 6 .....	£1,255
Band 7 .....	£1,334



**TL12FB**  
2 Seater with Full Back

Band 1 .....	£942
Band 2 .....	£1,014
Band 3 .....	£1,122
Band 4 .....	£1,217
Band 5 .....	£1,325
Band 6 .....	£1,420
Band 7 .....	£1,513



**TL12LB**  
2 Seater with Left Hand Back

Band 1 .....	£862
Band 2 .....	£922
Band 3 .....	£1,008
Band 4 .....	£1,088
Band 5 .....	£1,176
Band 6 .....	£1,255
Band 7 .....	£1,334



**NST066S**  
Square Table

Group Z .....	£532
---------------	------



**NST069S**  
Rectangular Table

Group Z .....	£591
---------------	------

5 Year  
Guarantee

## TAKE OFF LITE SOFT SEATING, RECEPTION & BREAKOUT



Reception,  
Breakout &  
Soft Seating

Camira Camira Patina Covered PAT14 Back Rest Camira Blazer Silverdale CUZ28 Seat with Grey Sled Frame

# LS24

## SOFT SEATING, RECEPTION & BREAKOUT

5 Year Guarantee

The LS24 is a timeless product that has been recently extended to include larger curved units. Reconfigurable and effective in a vast array of layouts, with a distinct design allowing for an imaginative use of fabric. Ideal for use in both small and large areas.

### Product Features



### Foot Colours



### Additional Information

Available in a variety of fabrics.



**LS24D1**  
Small Curve with Low Back

Band 1 .....	£1,236
Band 2 .....	£1,329
Band 3 .....	£1,472
Band 4 .....	£1,598
Band 5 .....	£1,738
Band 6 .....	£1,863
Band 7 .....	£1,993



**LS24D2**  
Small Curve with High Back

Band 1 .....	£1,295
Band 2 .....	£1,394
Band 3 .....	£1,546
Band 4 .....	£1,685
Band 5 .....	£1,835
Band 6 .....	£1,968
Band 7 .....	£2,104



**LS24E1**  
Large Curve with Low Back

Band 1 .....	£2,306
Band 2 .....	£2,433
Band 3 .....	£2,625
Band 4 .....	£2,797
Band 5 .....	£2,989
Band 6 .....	£3,160
Band 7 .....	£3,370



**LS24E2**  
Large Curve with High Back

Band 1 .....	£2,331
Band 2 .....	£2,471
Band 3 .....	£2,678
Band 4 .....	£2,869
Band 5 .....	£3,074
Band 6 .....	£3,260
Band 7 .....	£3,448



From L/R Camira Blazer Stanford CUZ2R, Sheffield CUZ1T, Barlborough CUZ3D (Band 4) surrounded by Colorado Mirage Pod in Oxford CUZ09



5 Year  
Guarantee

# LS24 SOFT SEATING, RECEPTION & BREAKOUT



**LS24A1**  
1 Seater with Low Back

Band 1 .....	£961
Band 2 .....	£1,018
Band 3 .....	£1,101
Band 4 .....	£1,176
Band 5 .....	£1,259
Band 6 .....	£1,336
Band 7 .....	£1,410



**LS24A2**  
1 Seater with High Back

Band 1 .....	£1,005
Band 2 .....	£1,060
Band 3 .....	£1,144
Band 4 .....	£1,220
Band 5 .....	£1,303
Band 6 .....	£1,377
Band 7 .....	£1,453



**LS24B1**  
2 Seater with Low Back

Band 1 .....	£1,558
Band 2 .....	£1,641
Band 3 .....	£1,770
Band 4 .....	£1,885
Band 5 .....	£2,011
Band 6 .....	£2,126
Band 7 .....	£2,239



**LS24B2**  
2 Seater with High Back

Band 1 .....	£1,601
Band 2 .....	£1,693
Band 3 .....	£1,828
Band 4 .....	£1,949
Band 5 .....	£2,083
Band 6 .....	£2,203
Band 7 .....	£2,322



**LS24C1**  
3 Seater with Low Back

Band 1 .....	£1,937
Band 2 .....	£2,044
Band 3 .....	£2,206
Band 4 .....	£2,352
Band 5 .....	£2,511
Band 6 .....	£2,657
Band 7 .....	£2,801



**LS24C2**  
3 Seater with High Back

Band 1 .....	£1,964
Band 2 .....	£2,074
Band 3 .....	£2,243
Band 4 .....	£2,394
Band 5 .....	£2,562
Band 6 .....	£2,712
Band 7 .....	£2,862



Kvadrat Canvas 2 0556 (Band 4) (Orange) and Kvadrat Canvas 2 0614 (Band 4) with White and Black Feet

# KULTURE CAPALDI

## SOFT SEATING, RECEPTION & BREAKOUT

5 Year  
Guarantee

# Kulture

Kulture Capaldi is an easily reconfigurable modular sofa designed specifically with the contract market in mind. The organically shaped rectangular units can be used individually, laid out in structured patterns or scattered throughout a space to create adaptable seating arrangements. The versatility of the design is endless, modules can be connected together in various ways, optimising soft seating in areas with space constraints in both public zones and private areas.

### Product Features



### Foot Colours



Black

### Additional Information

Available in a variety of fabrics.

### Example Configurations

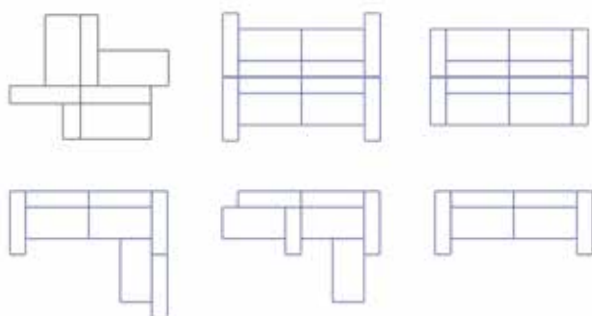

### Typical Linking Configuration

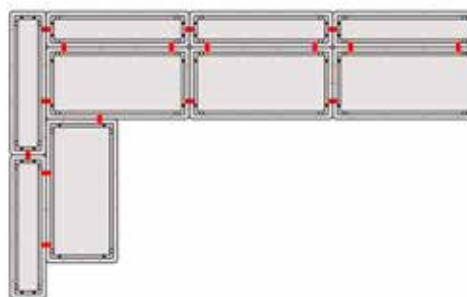

5 Year  
Guarantee

# KULTURE CAPALDI

## SOFT SEATING, RECEPTION & BREAKOUT



**KCSEAT**  
Seat Unit

W1180 x D590 x H440

Band 1	£859
Band 2	£904
Band 3	£966
Band 4	£
Band 5	1,025
Band 6	1,088
Band 7	1,146



**KCSEATING**  
Seat Unit

W1475 x D590 x H440

Band 1	£935
Band 2	£979
Band 3	£1,041
Band 4	£1,100
Band 5	£1,165
Band 6	£1,223
Band 7	£1,279



**KCBACK**  
Back Unit

W1180 x D295 x H762

Band 1	£727
Band 2	£788
Band 3	£868
Band 4	£942
Band 5	£
Band 6	1,027
Band 7	1,102



**KCLINK**  
Linking Brackets

£121



**KCLARM**  
Long Arm Unit

W885 x D295 x H630

Band 1	£550
Band 2	£576
Band 3	£609
Band 4	£641
Band 5	£677
Band 6	£707
Band 7	£740



**KCSARM**  
Short Arm Unit

W590 x D295 x H630

Band 1	£500
Band 2	£527
Band 3	£560
Band 4	£593
Band 5	£627
Band 6	£659
Band 7	£691



Reception,  
Breakout &  
Soft Seating

# NEOS

## SOFT SEATING, RECEPTION & BREAKOUT



Available in Two-tone fabric and a choice of bases.

- Generous seat & back for added comfort.
- Four star bases fitted with gas lift mechanism, raising the chair from reception to work/dining height.
- Matching tables available.

**R.** Optional Auto Return Column available.  
(Suffix code with R. Example: NPEPR)  
Surcharge.....£14

**T.** Optional Tilt Mechanism available.  
(Suffix code with T. Example: NPE4WT)  
Surcharge.....£47

### Frame Finishes

#### Metal

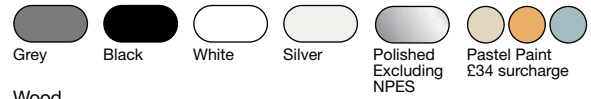

#### Wood



### Product Features



**NPES**  
Skid Frame

Band 1 .....	£741
Band 2 .....	£761
Band 3 .....	£789
Band 4 .....	£813
Band 5 .....	£840
Band 6 .....	£865
Band 7 .....	£888
Leather Group 1 .....	POA

**NPE4W**  
Four Star Base  
(With Castors)  
**T**

Band 1 .....	£792
Band 2 .....	£807
Band 3 .....	£835
Band 4 .....	£861
Band 5 .....	£887
Band 6 .....	£914
Band 7 .....	£940
Leather Group 1 .....	POA

**NPEP**  
Pyramid Base  
(With Castors)  
**R**

Band 1 .....	£888
Band 2 .....	£908
Band 3 .....	£938
Band 4 .....	£960
Band 5 .....	£988
Band 6 .....	£1,013
Band 7 .....	£1,037
Leather Group 1 .....	POA

**NPEPW**  
Pyramid Base  
(With Castors)  
**R**

Band 1 .....	£905
Band 2 .....	£922
Band 3 .....	£950
Band 4 .....	£975
Band 5 .....	£1,005
Band 6 .....	£1,029
Band 7 .....	£1,053
Leather Group 1 .....	POA



Svensson Iconic 5553 (Band 5) with White Skid Frame

# STRATT PLUS

## SOFT SEATING, RECEPTION & BREAKOUT

Stratt Plus is a timeless product that has been recently extended to include larger curved units.

- Reconfigurable and effective in a vast array of configurations.
- Distinct design allows for an imaginative use of fabric.
- Ideal for use in both small and large areas.

### Foot Colours



### Product Features



**STR1W**  
1 Seater with Wooden Leg

Band 1 .....	£980
Band 2 .....	£1,021
Band 3 .....	£1,087
Band 4 .....	£1,146
Band 5 .....	£1,210
Band 6 .....	£1,272
Band 7 .....	£1,329
Leather Group 1 .....	£2,012



**STR2W**  
2 Seater with Wooden Leg

Band 1 .....	£1,552
Band 2 .....	£1,606
Band 3 .....	£1,705
Band 4 .....	£1,794
Band 5 .....	£1,884
Band 6 .....	£1,969
Band 7 .....	£2,063
Leather Group 1 .....	£2,865



**STR3W**  
3 Seater with Wooden Leg

Band 1 .....	£1,742
Band 2 .....	£1,812
Band 3 .....	£1,948
Band 4 .....	£2,065
Band 5 .....	£2,180
Band 6 .....	£2,296
Band 7 .....	£2,412
Leather Group 1 .....	£3,493



**R8CURPW**  
Small Curve 45°  
with Wooden Leg

Band 1 .....	£1,111
Band 2 .....	£1,199
Band 3 .....	£1,307
Band 4 .....	£1,403
Band 5 .....	£1,500
Band 6 .....	£1,595
Band 7 .....	£1,691
Leather Group 1 .....	£2,173



**R16CURPW**  
Large Curve with Wooden  
Leg

Band 1 .....	£2,104
Band 2 .....	£2,188
Band 3 .....	£2,339
Band 4 .....	£2,471
Band 5 .....	£2,605
Band 6 .....	£2,737
Band 7 .....	£2,874
Leather Group 1 .....	£3,773

**STR1M**  
1 Seater with Chrome Leg

Band 1 .....	£1,193
Band 2 .....	£1,233
Band 3 .....	£1,299
Band 4 .....	£1,360
Band 5 .....	£1,421
Band 6 .....	£1,480
Band 7 .....	£1,540
Leather Group 1 .....	£2,051

**STR2M**  
2 Seater with Chrome Leg

Band 1 .....	£1,762
Band 2 .....	£1,815
Band 3 .....	£1,917
Band 4 .....	£2,005
Band 5 .....	£2,092
Band 6 .....	£2,183
Band 7 .....	£2,270
Leather Group 1 .....	£3,092

**STR3M**  
3 Seater with Chrome Leg

Band 1 .....	£1,955
Band 2 .....	£2,027
Band 3 .....	£2,157
Band 4 .....	£2,275
Band 5 .....	£2,390
Band 6 .....	£2,505
Band 7 .....	£2,623
Leather Group 1 .....	£3,732

**R8CURPM**  
Small Curve 45°  
with Chrome Leg

Band 1 .....	£1,345
Band 2 .....	£1,406
Band 3 .....	£1,515
Band 4 .....	£1,612
Band 5 .....	£1,705
Band 6 .....	£1,802
Band 7 .....	£1,899
Leather Group 1 .....	£2,490

**R16CURPM**  
Large Curve with Chrome  
Leg

Band 1 .....	£2,517
Band 2 .....	£2,599
Band 3 .....	£2,749
Band 4 .....	£2,882
Band 5 .....	£3,017
Band 6 .....	£3,151
Band 7 .....	£3,285
Leather Group 1 .....	£4,091



Camira X2 Polygon AK002 (Band 1) Seat and Camira Synergy Team LDS21 (Band 3) Back with Chrome Leg

# SOUND STATION

## SOFT SEATING, RECEPTION & BREAKOUT

2 Year Guarantee

The Sound Station Chair is a multi-purpose piece, a sound cocoon, allowing the user a comfortable and uninterrupted experience whilst making phone calls or listening to music in the office or in public spaces. It is the first chair with built-in Apple AirPlay technology, also supporting BlueTooth connectivity to virtually any device containing music and audio books such as laptop, mp3 player, mobile phone, tablet computer or even TV or Apple TV system.

### Base Options

Painted Plywood or Metal Powder-Coated Base

### Audio Systems Options

Available on SST2.

BOSE: producer of superior, high-end loudspeakers, amplifiers and audio systems; renowned worldwide.

ADRAudio: known to few audio aficionados and many concert organizers, ADRAudio designs state-of-the-art loudspeakers and live audio systems for the world's most respected artists.



SST1  
No Technology  
Audiovisual Isolation  
£8,134



SST2  
Technology  
Audiovisual Isolation /  
Intergrated Sound System &  
Receiver  
£12,901



SSTPAD  
iPad Holder  
£1,092



SSTP  
Foot Rest  
£1,038

### SOUND STATION FABRIC OPTIONS FAME BY GABRIEL



T 63016  
B RAL 2001

T 64089  
B RAL 3004

T 64168  
B RAL 3022

T 65084  
B RAL 5022

T 66075  
B RAL 5013

T 66118  
B RAL 5001

T 67016  
B RAL 5020

T 68004  
B RAL 6008

T 68035  
B RAL 6020

T 68069  
B RAL 6006



Gabriel Fame 68035

The Richmond sofa has been created as a blend of contemporary and traditional furniture. Its angular form is delicately rounded to help emphasise the comfort of the entire range.

- Deep seat cushions.
- Minimalist foot.
- Curved aesthetic.

Foot Colour



Product Features



**RIC1**  
1 Seater

Band 1 .....	£1,733
Band 2 .....	£1,807
Band 3 .....	£1,944
Band 4 .....	£2,066
Band 5 .....	£2,186
Band 6 .....	£2,306
Band 7 .....	£2,430
Leather Group 1 .....	£2,530



**RIC2**  
2 Seater

Band 1 .....	£2,540
Band 2 .....	£2,638
Band 3 .....	£2,810
Band 4 .....	£2,960
Band 5 .....	£3,111
Band 6 .....	£3,262
Band 7 .....	£3,417
Leather Group 1 .....	£3,671



**RIC3**  
3 Seater

Band 1 .....	£2,924
Band 2 .....	£3,050
Band 3 .....	£3,277
Band 4 .....	£3,482
Band 5 .....	£3,684
Band 6 .....	£3,883
Band 7 .....	£4,088
Leather Group 1 .....	£4,338



Vescom Bowen 7030.17 (Band 6)

# NAO

## SOFT SEATING, RECEPTION & BREAKOUT

5 Year Guarantee

The Nao collection includes stand-alone units that can be grouped to create varied arrangements.

- Suitable for busy workplaces breakout zones as well as more relaxed soft seating spaces.
- Well proportioned design.
- Panel details for extra customisation.

### Foot Colour

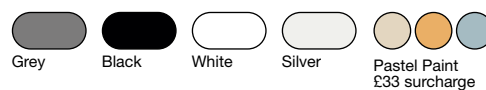

### Product Features



NAO1  
1 Seater

Band 1	£1,452
Band 2	£1,520
Band 3	£1,649
Band 4	£1,764
Band 5	£1,875
Band 6	£1,993
Band 7	£2,104
Leather Group 1	£2,598



NAO2  
2 Seater

Band 1	£1,977
Band 2	£2,073
Band 3	£2,248
Band 4	£2,404
Band 5	£2,559
Band 6	£2,711
Band 7	£2,865
Leather Group 1	£3,460



NAO3  
3 Seater

Band 1	£2,389
Band 2	£2,510
Band 3	£2,733
Band 4	£2,930
Band 5	£3,129
Band 6	£3,324
Band 7	£3,522
Leather Group 1	£4,196



Gabriel Fame 67067 (Band 4) Outer and Gabriel Fame 66133 (Band 4) Panel with Chrome Frame



# CLAIRE SOFT SEATING, RECEPTION & BREAKOUT

Classic proportions, clean lines and sophisticated design, Claire provides an excellent sit with the added elegance of a stylish leg frame.

- Individual removable cushions.
- Piped Edges for added quality.
- Robust frame construction.

### Frame Colours

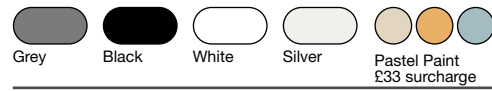

### Product Features



### Optional Extra

SCUSH Scatter Cushion (Band 1) £118



CY1  
1 Seater

Band 1 .....	£1,726
Band 2 .....	£1,811
Band 3 .....	£1,968
Band 4 .....	£2,110
Band 5 .....	£2,246
Band 6 .....	£2,387
Band 7 .....	£2,525
Leather Group 1 .....	£2,862



CY2  
2 Seater

Band 1 .....	£2,583
Band 2 .....	£2,701
Band 3 .....	£2,915
Band 4 .....	£3,104
Band 5 .....	£3,293
Band 6 .....	£3,484
Band 7 .....	£3,671
Leather Group 1 .....	£4,181



CY3  
3 Seater

Band 1 .....	£3,143
Band 2 .....	£3,294
Band 3 .....	£3,567
Band 4 .....	£3,813
Band 5 .....	£4,053
Band 6 .....	£4,297
Band 7 .....	£4,538
Leather Group 1 .....	£5,212



Camira Aspect Malham ACT29 (Band 2) with Grey Frame

# CHATTE

## SOFT SEATING, RECEPTION & BREAKOUT

5 Year Guarantee

Sophistication and practicality best describe the Chatte collection.

- Timeless style.
- Available in single, two and three seater versions.
- Range of leg options.

### Wooden Foot Colours



### Product Features



### Optional Extras



SCL Stiletto Chrome Leg  
Price is surcharge to wooden leg price £64



**CH1W**  
1 Seater with Wooden Legs

Band 1	£722
Band 2	£756
Band 3	£817
Band 4	£869
Band 5	£924
Band 6	£978
Band 7	£1,032
Leather Group 1	£1,372



**CH2W**  
2 Seater with Wooden Legs

Band 1	£1,216
Band 2	£1,285
Band 3	£1,408
Band 4	£1,520
Band 5	£1,629
Band 6	£1,741
Band 7	£1,852
Leather Group 1	£2,401



**CH3W**  
3 Seater with Wooden Legs

Band 1	£1,551
Band 2	£1,706
Band 3	£1,806
Band 4	£1,958
Band 5	£2,104
Band 6	£2,250
Band 7	£2,396
Leather Group 1	£3,051



**CH1M**  
1 Seater with Chrome Legs

Band 1	£893
Band 2	£927
Band 3	£988
Band 4	£1,042
Band 5	£1,097
Band 6	£1,150
Band 7	£1,203
Leather Group 1	£1,556



**CH2M**  
2 Seater with Chrome Legs

Band 1	£1,389
Band 2	£1,458
Band 3	£1,582
Band 4	£1,692
Band 5	£1,802
Band 6	£1,913
Band 7	£2,024
Leather Group 1	£2,577



**CH3M**  
3 Seater with Chrome Legs

Band 1	£1,723
Band 2	£1,811
Band 3	£1,978
Band 4	£2,127
Band 5	£2,275
Band 6	£2,419
Band 7	£2,568
Leather Group 1	£3,229

5 Year  
Guarantee

# CHATTE

SOFT SEATING, RECEPTION & BREAKOUT



Reception,  
Breakout &  
Soft Seating

Camira X2 Subtract AK013 (Band 1) with Chrome Legs

# OXY

## SOFT SEATING, RECEPTION & BREAKOUT

5 Year Guarantee

Oxy is a sophisticated range that is at home in a number of interiors.

- Offered as a 2 and 3 seater sofa with matching arm chair.
- Stylish flared arm design.
- Single seat cushion.

Foot Colour



Chrome

Product Features



Optional Extras

SCUSH Scatter Cushion (Band 1)

£118



OXY1  
1 Seater

Band 1 .....	£931
Band 2 .....	£977
Band 3 .....	£1,066
Band 4 .....	£1,137
Band 5 .....	£1,213
Band 6 .....	£1,290
Band 7 .....	£1,364
Leather Group 1 .....	£1,672



OXY2  
2 Seater

Band 1 .....	£1,309
Band 2 .....	£1,385
Band 3 .....	£1,511
Band 4 .....	£1,625
Band 5 .....	£1,737
Band 6 .....	£1,852
Band 7 .....	£1,965
Leather Group 1 .....	£2,691



OXY3  
3 Seater

Band 1 .....	£1,661
Band 2 .....	£1,764
Band 3 .....	£1,949
Band 4 .....	£2,114
Band 5 .....	£2,278
Band 6 .....	£2,441
Band 7 .....	£2,605
Leather Group 1 .....	£3,310



Camira Advantage Mineral AD010 (Band 1)



# ATRIUM

## SOFT SEATING, RECEPTION & BREAKOUT

Simple in shape, Atrium is easily reconfigurable making it ideal for busy workplaces as well as public use and educational spaces.

- Available with a choice of legs and in a wide variety of fabrics.

### Foot Colours

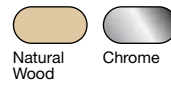

### Product Features



ATF1W 1 Seater Wooden Legs	
Band 1	£589
Band 2	£618
Band 3	£670
Band 4	£721
Band 5	£767
Band 6	£817
Band 7	£864
Leather Group 1	£1,218

ATF2W 2 Seater Wooden Legs	
Band 1	£1,175
Band 2	£1,236
Band 3	£1,343
Band 4	£1,437
Band 5	£1,534
Band 6	£1,629
Band 7	£1,726
Leather Group 1	£2,435

ATF1 1 Seater Chrome Legs	
Band 1	£589
Band 2	£618
Band 3	£670
Band 4	£721
Band 5	£767
Band 6	£817
Band 7	£864
Leather Group 1	£1,218

ATF2 2 Seater Chrome Legs	
Band 1	£1,175
Band 2	£1,236
Band 3	£1,343
Band 4	£1,437
Band 5	£1,534
Band 6	£1,629
Band 7	£1,726
Leather Group 1	£2,435



Gabriel Atlantic 65037 (Band 3) Seat with Chrome Legs

# OUTWOOD

## SOFT SEATING, RECEPTION & BREAKOUT

5 Year Guarantee

Outwood is a modular range that is ideally suited for use in an array of different environments.

- Customisable and reconfigurable.
- Deep cushions add extra comfort.
- Outwood is the collection that fits around the user.

Foot



Black  
Glide

Product Features



**OR1**  
1 Seater

Band 1 .....	£434
Band 2 .....	£470
Band 3 .....	£543
Band 4 .....	£606
Band 5 .....	£669
Band 6 .....	£730
Band 7 .....	£796
Leather Group 1 .....	POA



**ORA**  
1 Seater with Arms

Band 1 .....	£804
Band 2 .....	£864
Band 3 .....	£969
Band 4 .....	£1,066
Band 5 .....	£1,156
Band 6 .....	£1,250
Band 7 .....	£1,343
Leather Group 1 .....	POA



**ORR**  
1 Seater with Right Arm

Band 1 .....	£618
Band 2 .....	£676
Band 3 .....	£784
Band 4 .....	£876
Band 5 .....	£969
Band 6 .....	£1,066
Band 7 .....	£1,156
Leather Group 1 .....	POA



**ORL**  
1 Seater with Left Arm

Band 1 .....	£618
Band 2 .....	£676
Band 3 .....	£784
Band 4 .....	£876
Band 5 .....	£969
Band 6 .....	£1,066
Band 7 .....	£1,156
Leather Group 1 .....	POA



**ORGT**  
Glass Top Table  
750W x 750D x 440H

Band 1 .....	£368
Band 2 .....	£403
Band 3 .....	£466
Band 4 .....	£527
Band 5 .....	£580
Band 6 .....	£641
Band 7 .....	£698
Leather Group 1 .....	POA



**ORMTR**  
Wood Top Table  
750W x 750D x 440H

Band 1 .....	£368
Band 2 .....	£403
Band 3 .....	£466
Band 4 .....	£527
Band 5 .....	£580
Band 6 .....	£641
Band 7 .....	£698
Leather Group 1 .....	POA

5 Year  
Guarantee

# OUTWOOD

SOFT SEATING, RECEPTION & BREAKOUT



Reception,  
Breakout &  
Soft Seating

From L/R Camira Blazer Oriol CUZ18 (Band 4) and Camira Blazer Ulster CUZ1F (Band 4)

# SOLENT

## SOFT SEATING, RECEPTION & BREAKOUT

5 Year Guarantee

Solent is a visually distinctive offering that is based around the link between seat and back.

- Deep cushioned seat.
- Comfortable curved back.
- Perfect for use in a wide variety of environments such as touchdown, breakout, meeting spaces and waiting areas.
- Allows for an imaginative use of fabrics.
- Available with Wooden or Chrome foot.

### Foot Colours

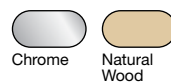

### Product Features



	1 Seater	
	SOL1W Wooden Leg	SOL1M Chrome Leg
Band 1 .....	£775.....	£960
Band 2 .....	£825.....	£994
Band 3 .....	£906.....	£1,077
Band 4 .....	£979.....	£1,151
Band 5 .....	£1,052.....	£1,224
Band 6 .....	£1,130.....	£1,299
Band 7 .....	£1,201.....	£1,371
Leather Group 1 .....	£1,762.....	£1,966

	2 Seater	
	SOL2W Wooden Leg	SOL2M Chrome Leg
Band 1 .....	£1,327.....	£1,497
Band 2 .....	£1,413.....	£1,583
Band 3 .....	£1,563.....	£1,735
Band 4 .....	£1,699.....	£1,868
Band 5 .....	£1,835.....	£2,003
Band 6 .....	£1,968.....	£2,139
Band 7 .....	£2,104.....	£2,274
Leather Group 1 .....	£2,676.....	£2,918

	3 Seater	
	SOL3W Wooden Leg	SOL3M Chrome Leg
Band 1 .....	£1,666.....	£1,838
Band 2 .....	£1,790.....	£1,961
Band 3 .....	£2,008.....	£2,183
Band 4 .....	£2,204.....	£2,378
Band 5 .....	£2,402.....	£2,573
Band 6 .....	£2,599.....	£2,768
Band 7 .....	£2,794.....	£2,965
Leather Group 1 .....	£3,335.....	£3,552



Camira Halcyon Aspen Tigerlilly HPA11 (Band 3) Seat and Camira Halcyon Aspen Almond HPA10 (Band 3) with Chrome Feet



# LYNSTOCK CHOICE RECEPTION

## SOFT SEATING, RECEPTION & BREAKOUT

Lynstock Choice is ideal for waiting area or heavy-traffic environments that need a uniform look.

- Constructed with a welded steel frame.
- Generously upholstered foam back and seat panels which allows specifiers to match interior decors.
- Chairs are available with or without arms, left or right hand arm.

### Product Features



### Frame Colours

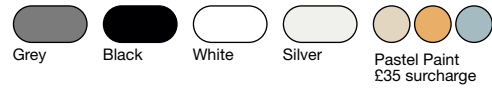

910  
Chair

Band 1 .....	£325
Band 2 .....	£352
Band 3 .....	£401
Band 4 .....	£446
Band 5 .....	£490
Band 6 .....	£534
Band 7 .....	£579
Leather Group 1 .....	£675



910RM  
Chair with Right Hand  
Moulded Arm

Band 1 .....	£357
Band 2 .....	£389
Band 3 .....	£438
Band 4 .....	£481
Band 5 .....	£525
Band 6 .....	£571
Band 7 .....	£617
Leather Group 1 .....	£715



910LM  
Chair with Left Hand  
Moulded Arm

Band 1 .....	£357
Band 2 .....	£389
Band 3 .....	£438
Band 4 .....	£481
Band 5 .....	£525
Band 6 .....	£571
Band 7 .....	£617
Leather Group 1 .....	£715



910AM  
Chair with Moulded Arms

Band 1 .....	£396
Band 2 .....	£424
Band 3 .....	£473
Band 4 .....	£516
Band 5 .....	£564
Band 6 .....	£609
Band 7 .....	£654
Leather Group 1 .....	£754



Bute Elgin Oxford CF667/0808 (Band 6) with Grey Frame

# PENNINE

## SOFT SEATING, RECEPTION & BREAKOUT

5 Year Guarantee

Pennine is the ideal choice for heavy-traffic environments that need the 'wood-frame' look.

- Laminated Beech frames provide strength and style.
- Cushioned upholstery allows specifiers to choose to match interior decors.
- Chairs are available with or without arms, left or right hand arm or stackable with matching reception tables.

### Frame Colours



Beech

### Product Features



**XO1**  
4 Leg Half Back (Stackable)

Band 1 .....	£293
Band 2 .....	£303
Band 3 .....	£336
Band 4 .....	£356
Band 5 .....	£380
Band 6 .....	£403
Band 7 .....	£426
Leather Group 1 .....	£557



**XO2**  
4 Leg Half Back with Arms (Stackable)

Band 1 .....	£319
Band 2 .....	£332
Band 3 .....	£357
Band 4 .....	£380
Band 5 .....	£404
Band 6 .....	£426
Band 7 .....	£448
Leather Group 1 .....	£579



**XO3**  
4 Leg Full Back with Arms

Band 1 .....	£387
Band 2 .....	£410
Band 3 .....	£448
Band 4 .....	£486
Band 5 .....	£520
Band 6 .....	£557
Band 7 .....	£593
Leather Group 1 .....	£750



**XO4**  
4 Leg Full Back

Band 1 .....	£345
Band 2 .....	£369
Band 3 .....	£407
Band 4 .....	£443
Band 5 .....	£479
Band 6 .....	£513
Band 7 .....	£550
Leather Group 1 .....	£698



Chieftain Just Colour Battleship Grey (Band 2)



# NEWTON

## SOFT SEATING, RECEPTION & BREAKOUT

Newton offers a timeless range of wood framed modular products that can be used collectively or individually.

- Welcoming wood finishes.
- Deep cushions for extra comfort.
- Ideal for residential surroundings where comfort and support is paramount.

### Frame Colours



Beech

### Product Features



**651**  
Medium Back

Band 1 .....	£598
Band 2 .....	£622
Band 3 .....	£670
Band 4 .....	£718
Band 5 .....	£760
Band 6 .....	£799
Band 7 .....	£842
Leather Group 1 .....	POA



**651A**  
Medium Back Armchair

Band 1 .....	£664
Band 2 .....	£690
Band 3 .....	£735
Band 4 .....	£775
Band 5 .....	£819
Band 6 .....	£861
Band 7 .....	£902
Leather Group 1 .....	POA



**650A**  
High Back Armchair

Band 1 .....	£742
Band 2 .....	£768
Band 3 .....	£819
Band 4 .....	£861
Band 5 .....	£905
Band 6 .....	£946
Band 7 .....	£991
Leather Group 1 .....	POA



**653T**  
Table 500W x 560D x 490H  
Price .....

£419



Panaz Highland 226 Lime (Band 2)

Reception,  
Breakout &  
Soft Seating

# CUBES & ARROWS

## SOFT SEATING, RECEPTION & BREAKOUT



Easy to reconfigure in any breakout or touch down area, Cubes and Arrows tessellate to enable a range of contemporary shapes to be created.

- Available with a number of base options and in our vast range of fabrics.
- Cubes and Arrows lend themselves to large atrium areas as well as difficult to plan areas.

### Product Features



### Foot Colours

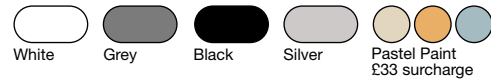

**ES01**  
Cube Single Seat with Glides

Band 1 .....	£325
Band 2 .....	£347
Band 3 .....	£389
Band 4 .....	£429
Band 5 .....	£466
Band 6 .....	£505
Band 7 .....	£542
Leather Group 1 .....	£618



**ES01M**  
Cube Single Seat with Metal Legs

Band 1 .....	£429
Band 2 .....	£452
Band 3 .....	£495
Band 4 .....	£533
Band 5 .....	£571
Band 6 .....	£609
Band 7 .....	£646
Leather Group 1 .....	£727



**ES01C**  
Cube Single Seat with Castors

Band 1 .....	£429
Band 2 .....	£452
Band 3 .....	£495
Band 4 .....	£533
Band 5 .....	£571
Band 6 .....	£609
Band 7 .....	£646
Leather Group 1 .....	£727



**AR1**  
Arrow Single Seat with Glides

Band 1 .....	£512
Band 2 .....	£534
Band 3 .....	£577
Band 4 .....	£614
Band 5 .....	£654
Band 6 .....	£692
Band 7 .....	£728
Leather Group 1 .....	£909



**AR1M**  
Arrow Single Seat with Metal Legs

Band 1 .....	£604
Band 2 .....	£630
Band 3 .....	£669
Band 4 .....	£707
Band 5 .....	£748
Band 6 .....	£786
Band 7 .....	£825
Leather Group 1 .....	£1,000

5 Year  
Guarantee

## CUBES & ARROWS

SOFT SEATING, RECEPTION & BREAKOUT



Reception,  
Breakout &  
Soft Seating

Camira X2 Subtract AK013 (Band 1) with Glides

# MOONS & ROUNDS

## SOFT SEATING, RECEPTION & BREAKOUT

5 Year  
Guarantee

The perfect match for any breakout or touch down area, Moons & Rounds nest together to provide a seamless blend of function and style.

- Simple to configure.
- Multiple options.
- Perfect for a number of different areas.

### Product Features



### Foot Colours

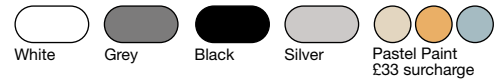

From L/R Svensson Accessoire River, Nest and Bok (Band 6) with Black Metal Legs

# MOONS & ROUNDS

## SOFT SEATING, RECEPTION & BREAKOUT



**R500**

Small Round with Glides

Band 1	£463
Band 2	£488
Band 3	£529
Band 4	£568
Band 5	£604
Band 6	£643
Band 7	£678
Leather Group 1	£909



**R500M**

Small Round with Metal Legs

Band 1	£568
Band 2	£591
Band 3	£632
Band 4	£666
Band 5	£700
Band 6	£735
Band 7	£770
Leather Group 1	£1,003



**R500C**

Small Round with Castors

Band 1	£568
Band 2	£591
Band 3	£632
Band 4	£666
Band 5	£700
Band 6	£735
Band 7	£770
Leather Group 1	£1,003



**R800**

Medium Round

Band 1	£704
Band 2	£741
Band 3	£804
Band 4	£864
Band 5	£922
Band 6	£979
Band 7	£1,038
Leather Group 1	£1,151



**R800M**

Medium Round with Chrome Legs

Band 1	£817
Band 2	£854
Band 3	£916
Band 4	£976
Band 5	£1,032
Band 6	£1,091
Band 7	£1,146
Leather Group 1	£1,259



**R800C**

Medium Round with Castors

Band 1	£817
Band 2	£854
Band 3	£916
Band 4	£976
Band 5	£1,032
Band 6	£1,091
Band 7	£1,146
Leather Group 1	£1,259



**R1000**

Large Round with Glides

Band 1	£930
Band 2	£970
Band 3	£1,047
Band 4	£1,113
Band 5	£1,183
Band 6	£1,251
Band 7	£1,279
Leather Group 1	£1,794



**R1000M**

Large Round with Metal Legs

Band 1	£1,032
Band 2	£1,073
Band 3	£1,152
Band 4	£1,218
Band 5	£1,288
Band 6	£1,357
Band 7	£1,424
Leather Group 1	£1,898



**M500**

Small Moon with Glides

Band 1	£489
Band 2	£512
Band 3	£555
Band 4	£594
Band 5	£632
Band 6	£668
Band 7	£705
Leather Group 1	£959



**M500M**

Small Moon with Metal Legs

Band 1	£594
Band 2	£613
Band 3	£657
Band 4	£691
Band 5	£725
Band 6	£762
Band 7	£796
Leather Group 1	£1,050



**M500C**

Small Moon with Castors

Band 1	£594
Band 2	£613
Band 3	£657
Band 4	£691
Band 5	£725
Band 6	£762
Band 7	£796
Leather Group 1	£1,050



**M800**

Medium Moon

Band 1	£788
Band 2	£802
Band 3	£891
Band 4	£947
Band 5	£1,006
Band 6	£1,069
Band 7	£1,122
Leather Group 1	£1,231



**M800**

Large Moon with Glides

Band 1	£978
Band 2	£1,021
Band 3	£1,100
Band 4	£1,166
Band 5	£1,236
Band 6	£1,301
Band 7	£1,370
Leather Group 1	£1,882



**M800C**

Large Moon with Metal Legs

Band 1	£1,082
Band 2	£1,123
Band 3	£1,201
Band 4	£1,271
Band 5	£1,339
Band 6	£1,404
Band 7	£1,473
Leather Group 1	£1,981



**M1000**

Medium Moon with Chrome Legs

Band 1	£893
Band 2	£931
Band 3	£994
Band 4	£1,052
Band 5	£1,108
Band 6	£1,168
Band 7	£1,226
Leather Group 1	£1,338



**M1000M**

Medium Moon with Castors

Band 1	£893
Band 2	£931
Band 3	£994
Band 4	£1,052
Band 5	£1,108
Band 6	£1,168
Band 7	£1,226
Leather Group 1	£1,338

# CURVES, OVALS & RECTANGLES

## SOFT SEATING, RECEPTION & BREAKOUT

5 Year Guarantee

When used alone, or when accompanying fellow products from the Cubes and Arrows collection, Curves and Ovals add a playful edge whereas Rectangles add practicality and space. These simple shapes can revitalise any reception, breakout or lounge area.

- Simple to configure.
- Multiple options.
- Perfect for a number of different areas.

### Product Features



### Foot Colours



### Additional Information

Available in a variety of fabrics.



**EC2**  
2 Seater Curve with Glides

Band 1 .....	£951
Band 2 .....	£996
Band 3 .....	£1,084
Band 4 .....	£1,146
Band 5 .....	£1,236
Band 6 .....	£1,309
Band 7 .....	£1,388
Leather Group 1 .....	POA



**EC2M**  
2 Seater Curve Metal Legs

Band 1 .....	£1,112
Band 2 .....	£1,152
Band 3 .....	£1,224
Band 4 .....	£1,287
Band 5 .....	£1,353
Band 6 .....	£1,413
Band 7 .....	£1,477
Leather Group 1 .....	POA



**ER2**  
2 Seater Oval

Band 1 .....	£741
Band 2 .....	£799
Band 3 .....	£905
Band 4 .....	£997
Band 5 .....	£1,091
Band 6 .....	£1,186
Band 7 .....	£1,278
Leather Group 1 .....	POA



**ER2M**  
2 Seater Oval with Metal Legs

Band 1 .....	£906
Band 2 .....	£945
Band 3 .....	£1,068
Band 4 .....	£1,161
Band 5 .....	£1,255
Band 6 .....	£1,349
Band 7 .....	£1,442
Leather Group 1 .....	POA



**ES02**  
2 Seater Unit with Glides

Band 1 .....	£609
Band 2 .....	£644
Band 3 .....	£706
Band 4 .....	£764
Band 5 .....	£819
Band 6 .....	£875
Band 7 .....	£931
Leather Group 1 .....	£1,092



**ES02M**  
2 Seater Unit with Metal Legs

Band 1 .....	£771
Band 2 .....	£806
Band 3 .....	£872
Band 4 .....	£927
Band 5 .....	£980
Band 6 .....	£1,038
Band 7 .....	£1,092
Leather Group 1 .....	£1,252



# CURVES, OVALS & RECTANGLES

SOFT SEATING, RECEPTION & BREAKOUT



# LS35

## SOFT SEATING, RECEPTION & BREAKOUT



A developed version of Moons & Rounds brings the LS35 collection, a tapered silhouette with contrasting cushioned top.

Matching coffee tables and dining tables are also available to create an informal dining space or breakout area.

### Product Features



### Additional Information

Table tops available in all standard 25mm GOF MFC.



**LS35A**  
Tapered Stool with Glides

Band 1 .....	£429
Band 2 .....	£454
Band 3 .....	£485
Band 4 .....	£513
Band 5 .....	£545
Band 6 .....	£575
Band 7 .....	£603



**LS35B**  
Low Table  
385mm Coffee Height

Band 1 .....	£369
Band 2 .....	£388
Band 3 .....	£413
Band 4 .....	£440
Band 5 .....	£465
Band 6 .....	£490
Band 7 .....	£513



**LS35C**  
High Table  
710mm Dining Height

Band 1 .....	£669
Band 2 .....	£694
Band 3 .....	£724
Band 4 .....	£753
Band 5 .....	£786
Band 6 .....	£814
Band 7 .....	£842



Camira Blazer Silcoates CUZ30 (Band 4) Base and Camira Blazer Plymouth CUZ1R (Band 4) Top and White MFC

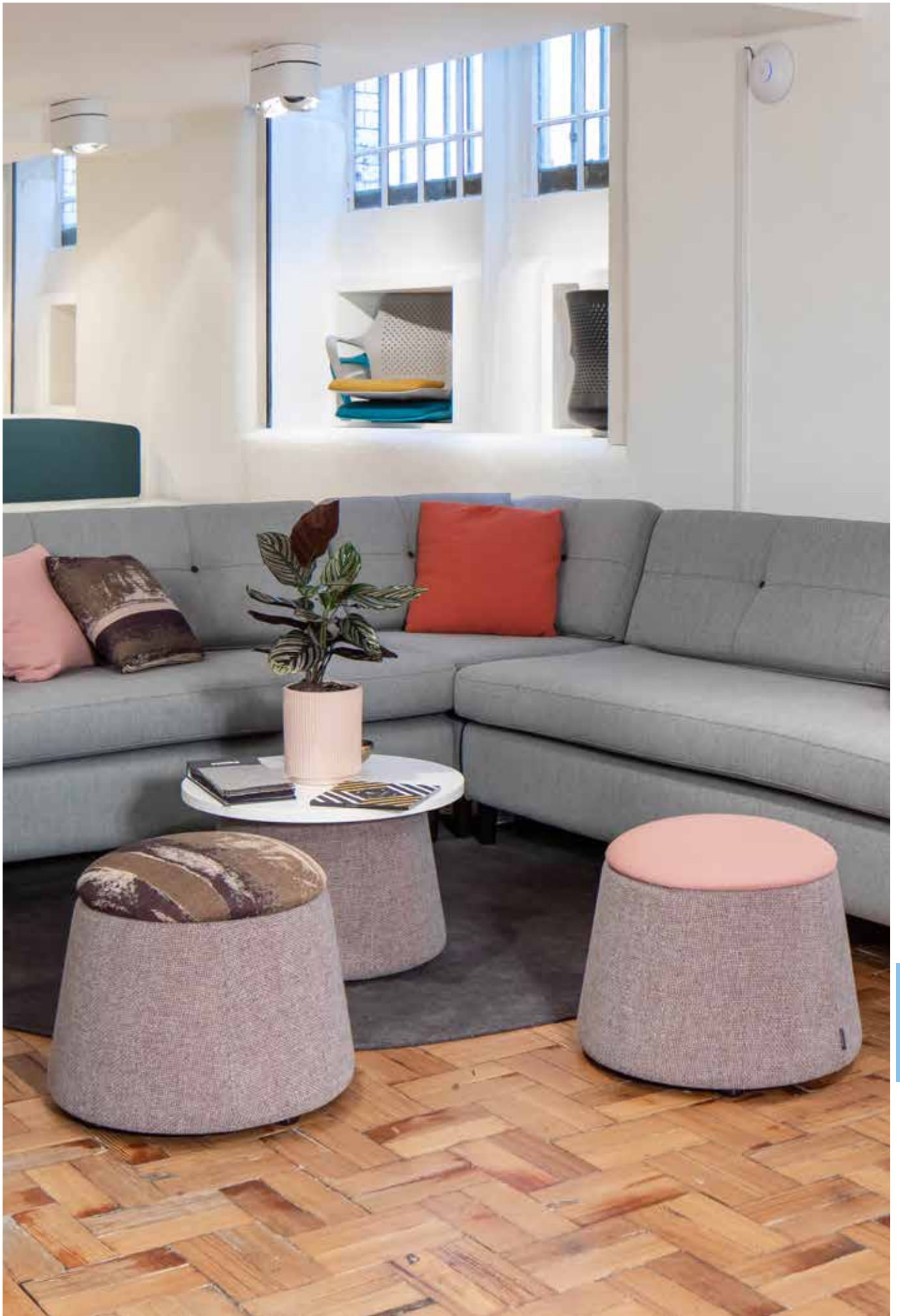

Reception, Breakout & Soft Seating

# INTRODUCTION

## BEAM SEATING

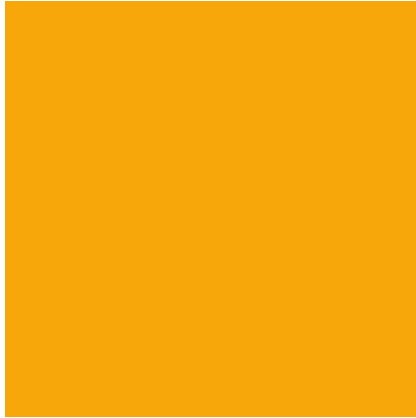



Items are available in a variety of fabrics. A number of products possess certain upholstery restrictions - these are therefore available in selected fabrics only and are identified within this brochure.

For further information regarding fabric suitability - Please contact our Sales Department



Arms are available on designated product ranges as indicated within the relevant product thumbnails. Colour / Finish options are indicated on relevant product pages - where applicable.

For further information regarding Arm options - Please contact our Sales Department.



Items include Reflex Foam Structure as standard.

Level 'S' tested to BS5459: Part 2: 2000.

Extreme Comfort.

Consistent Shape Retention.

Durability and long life.

Excellent Fire Retardant Properties.

---

We recommend that you request fabric samples prior to ordering.

Two tone upholstery is available on selected products.  
Please contact our Sales Department for further information.

You can find dimensions for all products in the technical data section of this brochure.

Please Note: All images shown are for illustrative purposes.

Some aspects of certain products may differ.  
Please contact our customer services department with any queries.

# SJX BEAM BEAM SEATING



SJX Beam is the perfect seating solution for a variety of applications, with fully upholstered, mesh back and upholstered seat or plastic seat and back options and four coloured plastics. The shape of the seat back promotes good posture for long periods of sitting, preventing back ache. For areas with high traffic, alternative floor fixing end frames are offered to allow for units to be bolted to the floor for health and safety reasons. SJX Beam is available as two, three, four or five seats with table configurations.

### Plastic Colours



### Frame Colours

End frames available in Black.  
Underframes are Black only.  
Polished Chrome end frames  
£160 surcharge.



**-FF** alternative floor fixing end frame (Black only)

### Additional Information

Tables are available in any standard MFC wood finish and can be placed in any position, please specify at point of order. Position is as viewed from the front. When ordering please state position of arms as viewed from the front. Alternative floor fixing end frames are available (please suffix code with **-FF**).

### Technical Data

Seat Height: 460mm; Height Over Arms 685mm

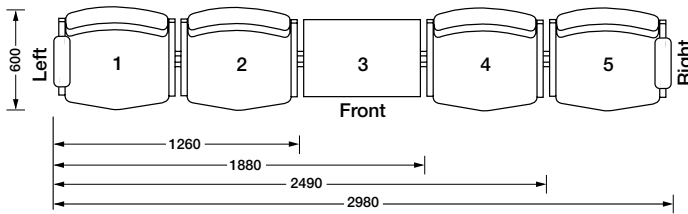

All dimensions are approximate and are for guidance only.

SJXB2SU 2 Seats Fully Upholstered	SJXB2STU 2 Seats/1 Table Fully Upholstered	SJXB3SU 3 Seats Fully Upholstered	SJXB3STU 3 Seats/1 Table Fully Upholstered	SJXB4SU 4 Seats Fully Upholstered
Band 1 .....£786	Band 1 .....£860	Band 1 .....£1,063	Band 1 .....£1,136	Band 1 .....£1,345
Band 2 .....£804	Band 2 .....£880	Band 2 .....£1,093	Band 2 .....£1,170	Band 2 .....£1,388
Band 3 .....£844	Band 3 .....£921	Band 3 .....£1,152	Band 3 .....£1,228	Band 3 .....£1,465
Band 4 .....£877	Band 4 .....£954	Band 4 .....£1,202	Band 4 .....£1,279	Band 4 .....£1,533
Band 5 .....£911	Band 5 .....£986	Band 5 .....£1,253	Band 5 .....£1,329	Band 5 .....£1,602
Band 6 .....£946	Band 6 .....£1,024	Band 6 .....£1,305	Band 6 .....£1,379	Band 6 .....£1,671
Band 7 .....£979	Band 7 .....£1,058	Band 7 .....£1,354	Band 7 .....£1,429	Band 7 .....£1,737





# SJX BEAM BEAM SEATING

<p><b>SJXB4STU</b> 4 Seats/ 1 Table Fully Upholstered</p> <p>Band 1 .....£1,421 Band 2 .....£1,460 Band 3 .....£1,537 Band 4 .....£1,604 Band 5 .....£1,673 Band 6 .....£1,742 Band 7 .....£1,810</p>	<p><b>SJXB5SU</b> 5 Seats Fully Upholstered</p> <p>Band 1 .....£1,633 Band 2 .....£1,687 Band 3 .....£1,784 Band 4 .....£1,868 Band 5 .....£1,953 Band 6 .....£2,039 Band 7 .....£2,126</p>	<p><b>SJXB2SM</b> 2 Seats Mesh Back/Upholstered Seat</p> <p>Band 1 .....£786 Band 2 .....£804 Band 3 .....£844 Band 4 .....£877 Band 5 .....£911 Band 6 .....£946 Band 7 .....£979</p>	<p><b>SJXB2STM</b> 2 Seats/1 Table Mesh Back/Upholstered Seat</p> <p>Band 1 .....£860 Band 2 .....£880 Band 3 .....£921 Band 4 .....£954 Band 5 .....£986 Band 6 .....£1,024 Band 7 .....£1,058</p>	<p><b>SJXB3SM</b> 3 Seats Mesh Back/Upholstered Seat</p> <p>Band 1 .....£1,063 Band 2 .....£1,093 Band 3 .....£1,152 Band 4 .....£1,202 Band 5 .....£1,253 Band 6 .....£1,305 Band 7 .....£1,354</p>
<p><b>SJXB3STM</b> 3 Seats/1 Table Mesh Back/Upholstered Seat</p> <p>Band 1 .....£1,136 Band 2 .....£1,170 Band 3 .....£1,228 Band 4 .....£1,279 Band 5 .....£1,329 Band 6 .....£1,379 Band 7 .....£1,429</p>	<p><b>SJXB4SM</b> 4 Seats Mesh Back/Upholstered Seat</p> <p>Band 1 .....£1,345 Band 2 .....£1,388 Band 3 .....£1,465 Band 4 .....£1,533 Band 5 .....£1,602 Band 6 .....£1,671 Band 7 .....£1,737</p>	<p><b>SJXB4STM</b> 4 Seats/ 1 Table Mesh Back/Upholstered Seat</p> <p>Band 1 .....£1,421 Band 2 .....£1,460 Band 3 .....£1,537 Band 4 .....£1,604 Band 5 .....£1,673 Band 6 .....£1,742 Band 7 .....£1,810</p>	<p><b>SJXB5SM</b> 5 Seats Mesh Back/Upholstered Seat</p> <p>Band 1 .....£1,633 Band 2 .....£1,687 Band 3 .....£1,784 Band 4 .....£1,868 Band 5 .....£1,953 Band 6 .....£2,039 Band 7 .....£2,124</p>	<p><b>SJXB2SP</b> 2 Seats Plastic Seat &amp; Back</p> <p>Price .....£584</p>
<p><b>SJXB2STP</b> 2 Seats/1 Table Plastic Seat &amp; Back</p> <p>Price .....£658</p>	<p><b>SJXB3SP</b> 3 Seats Plastic Seat &amp; Back</p> <p>Price .....£781</p>	<p><b>SJXB3STP</b> 3 Seats/1 Table Plastic Seat &amp; Back</p> <p>Price .....£857</p>	<p><b>SJXB4SP</b> 4 Seats Plastic Seat &amp; Back</p> <p>Price .....£990</p>	<p><b>SJXB4STP</b> 4 Seats/ 1 Table Plastic Seat &amp; Back</p> <p>Price .....£1,064</p>
<p><b>SJXB5SP</b> 5 Seats Plastic Seat &amp; Back</p> <p>Price .....£1,194</p>	<p><b>SJXBARM</b> Optional Black Moulded Arm (pair)</p> <p>Price .....£44</p>	<p><b>-FF</b> Floor fixing end frame Surcharge per unit</p> <p>Price .....£62</p>		



# ZELA BEAM BEAM SEATING



Zela Beam is a versatile and comfortable, modern polypropylene conference seat, which utilises the very latest moulding techniques, with fully upholstered, upholstered seat or plastic seat and back options, and the opportunity to choose from a selection of eight coloured plastics to personalise your space. This hard wearing, elegant and versatile, Beam Seating range is perfect for small reception areas, large waiting rooms and transport lounges. Zela Beam is available as two, three, four or five seats with table configurations.

### Plastic Colours

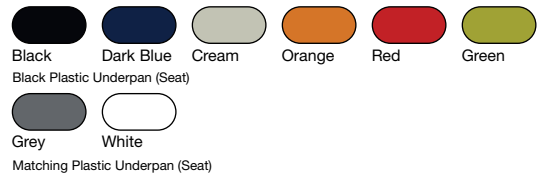

### Technical Data

Seat Height: 460mm; Height Over Arms 685mm

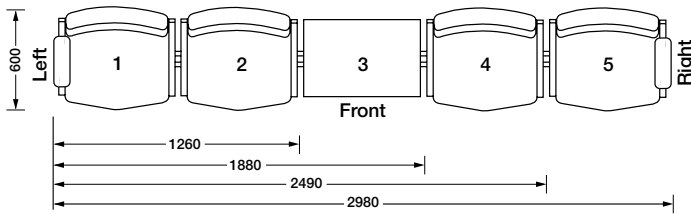

All dimensions are approximate and are for guidance only.

### Frame Colours

End frames available in Black. Underframes are Black only. Polished Chrome end frames £160 surcharge.

### Additional Information

Tables are available in any standard MFC wood finish and can be placed in any position, please specify at point of order. Position is as viewed from the front. Fully upholstered has a choice of Black, White or Grey shell. Underpan Black as standard except when White or Grey back plastics are used, which have matching underpans / Back Plastic (Un-upholstered) available in a choice of 8 colours. When ordering please state position of arms as viewed from the front.

ZLB2BP 2 Seats Fully Upholstered	ZLB2TBP 2 Seats/1 Table Fully Upholstered	ZLB3BP 3 Seats Fully Upholstered	ZLB3TBP 3 Seats/1 Table Fully Upholstered	ZLB4BP 4 Seats Fully Upholstered
Band 1 .....£646	Band 1 .....£775	Band 1 .....£973	Band 1 .....£1,100	Band 1 .....£1,296
Band 2 .....£666	Band 2 .....£795	Band 2 .....£1,001	Band 2 .....£1,130	Band 2 .....£1,334
Band 3 .....£699	Band 3 .....£830	Band 3 .....£1,045	Band 3 .....£1,177	Band 3 .....£1,399
Band 4 .....£729	Band 4 .....£859	Band 4 .....£1,091	Band 4 .....£1,223	Band 4 .....£1,456
Band 5 .....£758	Band 5 .....£888	Band 5 .....£1,135	Band 5 .....£1,263	Band 5 .....£1,515
Band 6 .....£788	Band 6 .....£916	Band 6 .....£1,179	Band 6 .....£1,308	Band 6 .....£1,572
Band 7 .....£816	Band 7 .....£946	Band 7 .....£1,224	Band 7 .....£1,352	Band 7 .....£1,784





# ZELA BEAM BEAM SEATING

2 Year  
Guarantee

## ZLB4TBP 4 Seats/1 Table Fully Upholstered

Band 1	£1,424
Band 2	£1,463
Band 3	£1,528
Band 4	£1,585
Band 5	£1,643
Band 6	£1,703
Band 7	£1,762

## ZLB5BP 5 Seats Fully Upholstered

Band 1	£1,620
Band 2	£1,666
Band 3	£1,745
Band 4	£1,821
Band 5	£1,894
Band 6	£1,965
Band 7	£2,040

## ZLB2SP 2 Seats Plastic back/upholstered seat

Band 1	£598
Band 2	£618
Band 3	£650
Band 4	£680
Band 5	£709
Band 6	£738
Band 7	£767

## ZLB2TSP 2 Seats/1 Table Plastic back/upholstered seat

Band 1	£729
Band 2	£746
Band 3	£781
Band 4	£810
Band 5	£840
Band 6	£868
Band 7	£897

## ZLB3SP 3 Seats Plastic back/upholstered seat

Band 1	£899
Band 2	£925
Band 3	£976
Band 4	£1,018
Band 5	£1,063
Band 6	£1,105
Band 7	£1,151

## ZLB3TSP 3 Seats/1 Table Plastic back/upholstered seat

Band 1	£1,028
Band 2	£1,058
Band 3	£1,102
Band 4	£1,150
Band 5	£1,193
Band 6	£1,236
Band 7	£1,279

## ZLB4SP 4 Seats Plastic back/upholstered seat

Band 1	£1,198
Band 2	£1,236
Band 3	£1,301
Band 4	£1,360
Band 5	£1,417
Band 6	£1,474
Band 7	£1,533

## ZLB4TSP 4 Seats/1 Table Plastic back/upholstered seat

Band 1	£1,329
Band 2	£1,365
Band 3	£1,429
Band 4	£1,489
Band 5	£1,550
Band 6	£1,604
Band 7	£1,665

## ZLB5SP 5 Seats Plastic back/upholstered seat

Band 1	£1,499
Band 2	£1,542
Band 3	£1,626
Band 4	£1,699
Band 5	£1,771
Band 6	£1,842
Band 7	£1,920

## ZLB2SX 2 Seats Plastic seat & back

Price	£553
-------	------

## ZLB2TSX 2 Seats/1 Table Plastic seat & back

Price	£680
-------	------

## ZLB3SX 3 Seats Plastic seat & back

Price	£828
-------	------

## ZLB3TSX 3 Seats/1 Table Plastic seat & back

Price	£955
-------	------

## ZLB4SX 4 Seats Plastic seat & back

Price	£1,100
-------	--------

## ZLB4TSX 4 Seats/1 Table Plastic seat & back

Price	£1,231
-------	--------

## ZLB5SX 5 Seats Plastic seat & back

Price	£1,376
-------	--------

## ZLBARM Black Arm (each)

Price	£25
-------	-----

## Polished Aluminium Arm surcharge (each)

Price	£48
-------	-----



# ELSA TRIANGULAR BEAM BEAM SEATING



Elsa Beam is a premium and robust beam system that lends the design from our Heavy Duty chair range for a secure and comfortable waiting room row seat. The units are ideal for hospital and medical reception rooms, waiting areas and other public area environments. The fully upholstered CMHR foam back is offered in high, full and three-quarter size with a similarly upholstered seat for ultra-comfort for long periods of sitting. Elsa Beam is available as two, three or four seats with table configurations and a choice of a triangular frame or angular frame for a modern look and premium feel. Triangular end frames have pre-drilled holes for floor fixing.

### Technical Data

**Seat Height: 490mm; Height Over Arms 625mm**

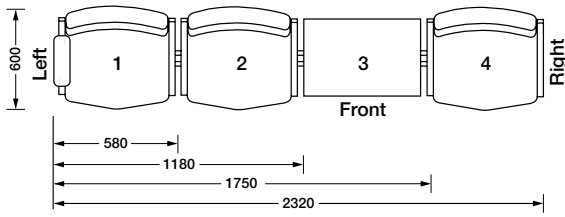

All dimensions are approximate and are for guidance only.

EHR2 2 Seats High Back		EHR2T 2 Seats/1 Table High Back		EHR3 3 Seats High Back		EHR3T 3 Seats/1 Table High Back		EHR4 4 Seats High Back	
Band 1	£830	Band 1	£951	Band 1	£1,183	Band 1	£1,336	Band 1	£1,568
Band 2	£877	Band 2	£999	Band 2	£1,257	Band 2	£1,407	Band 2	£1,667
Band 3	£966	Band 3	£1,087	Band 3	£1,388	Band 3	£1,537	Band 3	£1,841
Band 4	£1,042	Band 4	£1,164	Band 4	£1,503	Band 4	£1,656	Band 4	£1,997
Band 5	£1,121	Band 5	£1,240	Band 5	£1,622	Band 5	£1,771	Band 5	£2,155
Band 6	£1,198	Band 6	£1,319	Band 6	£1,737	Band 6	£1,889	Band 6	£2,310
Band 7	£1,277	Band 7	£1,395	Band 7	£1,855	Band 7	£2,006	Band 7	£2,465

### Frame Colours

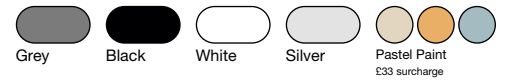

### Additional Information

Tables are available in any standard MFC wood finish and can be placed in any position, please specify at point of order. Position is as viewed from the front.

When ordering arms please state position of as viewed from the front.

Optional Moulded Arm (each) £37



2 Year  
Guarantee

# ELSA TRIANGULAR BEAM BEAM SEATING

## EFR2 2 Seats Full Back

Band 1 .....	£795
Band 2 .....	£844
Band 3 .....	£932
Band 4 .....	£1,008
Band 5 .....	£1,088
Band 6 .....	£1,165
Band 7 .....	£1,241

## EFR2T 2 Seats/1 Table Full Back

Band 1 .....	£914
Band 2 .....	£963
Band 3 .....	£1,051
Band 4 .....	£1,129
Band 5 .....	£1,207
Band 6 .....	£1,283
Band 7 .....	£1,362

## EFR3 3 Seats Full Back

Band 1 .....	£1,131
Band 2 .....	£1,203
Band 3 .....	£1,338
Band 4 .....	£1,453
Band 5 .....	£1,568
Band 6 .....	£1,685
Band 7 .....	£1,802

## EFR3T 3 Seats/1 Table Full Back

Band 1 .....	£1,282
Band 2 .....	£1,354
Band 3 .....	£1,488
Band 4 .....	£1,602
Band 5 .....	£1,721
Band 6 .....	£1,837
Band 7 .....	£1,955

## EFR4 4 Seats Full Back

Band 1 .....	£1,499
Band 2 .....	£1,598
Band 3 .....	£1,772
Band 4 .....	£1,929
Band 5 .....	£2,086
Band 6 .....	£2,239
Band 7 .....	£2,397

## EQR2 2 Seats 3/4 Back

Band 1 .....	£690
Band 2 .....	£720
Band 3 .....	£769
Band 4 .....	£814
Band 5 .....	£861
Band 6 .....	£906
Band 7 .....	£953

## EQR2T 2 Seats/1 Table 3/4 Back

Band 1 .....	£831
Band 2 .....	£860
Band 3 .....	£911
Band 4 .....	£956
Band 5 .....	£1,003
Band 6 .....	£1,050
Band 7 .....	£1,093

## EQR3 3 Seats 3/4 Back

Band 1 .....	£932
Band 2 .....	£975
Band 3 .....	£1,052
Band 4 .....	£1,121
Band 5 .....	£1,191
Band 6 .....	£1,258
Band 7 .....	£1,325

## EQR3T 3 Seats/1 Table 3/4 Back

Band 1 .....	£1,070
Band 2 .....	£1,116
Band 3 .....	£1,193
Band 4 .....	£1,261
Band 5 .....	£1,330
Band 6 .....	£1,399
Band 7 .....	£1,466

## EQR4 4 Seats 3/4 Back

Band 1 .....	£1,170
Band 2 .....	£1,229
Band 3 .....	£1,331
Band 4 .....	£1,423
Band 5 .....	£1,515
Band 6 .....	£1,604
Band 7 .....	£1,699



# ELSA ANGULAR BEAM BEAM SEATING



Elsa Beam is a premium and robust beam system that lends the design from our Heavy Duty chair range for a secure and comfortable waiting room row seat. The units are ideal for hospital and medical reception rooms, waiting areas and other public area environments. The fully upholstered CMHR foam back is offered in high, full and three-quarter size with a similarly upholstered seat for ultra-comfort for long periods of sitting. Elsa Beam is available as two, three or four seats with table configurations and a choice of a triangular frame or angular frame for a modern look and premium feel.

### Technical Data

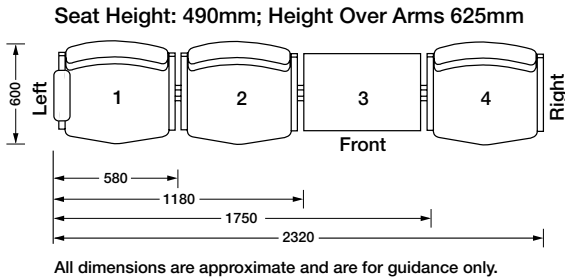

### Frame Colours

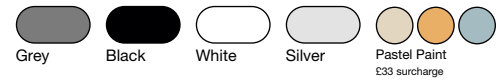

### Additional Information

Tables are available in any standard MFC wood finish and can be placed in any position, please specify at point of order. Position is as viewed from the front.

When ordering arms please state position of as viewed from the front.

Optional Moulded Arm (each) £37



EHA2 2 Seats High Back	EHA2T 2 Seats/1 Table High Back	EHA3 3 Seats High Back	EHA3T 3 Seats/1 Table High Back	EHA4 4 Seats High Back
Band 1 .....£830	Band 1 .....£951	Band 1 .....£1,183	Band 1 .....£1,336	Band 1 .....£1,568
Band 2 .....£877	Band 2 .....£999	Band 2 .....£1,257	Band 2 .....£1,407	Band 2 .....£1,667
Band 3 .....£966	Band 3 .....£1,087	Band 3 .....£1,388	Band 3 .....£1,537	Band 3 .....£1,841
Band 4 .....£1,042	Band 4 .....£1,164	Band 4 .....£1,503	Band 4 .....£1,656	Band 4 .....£1,997
Band 5 .....£1,121	Band 5 .....£1,240	Band 5 .....£1,622	Band 5 .....£1,771	Band 5 .....£2,155
Band 6 .....£1,198	Band 6 .....£1,319	Band 6 .....£1,737	Band 6 .....£1,889	Band 6 .....£2,310
Band 7 .....£1,277	Band 7 .....£1,395	Band 7 .....£1,855	Band 7 .....£2,006	Band 7 .....£2,465



2 Year  
Guarantee

# ELSA ANGULAR BEAM BEAM SEATING

## EFA2 2 Seats Full Back

Band 1 .....	£795
Band 2 .....	£844
Band 3 .....	£932
Band 4 .....	£1,008
Band 5 .....	£1,088
Band 6 .....	£1,165
Band 7 .....	£1,241

## EFA2T 2 Seats/1 Table Full Back

Band 1 .....	£914
Band 2 .....	£963
Band 3 .....	£1,051
Band 4 .....	£1,129
Band 5 .....	£1,207
Band 6 .....	£1,283
Band 7 .....	£1,362

## EFA3 3 Seats Full Back

Band 1 .....	£1,131
Band 2 .....	£1,203
Band 3 .....	£1,338
Band 4 .....	£1,453
Band 5 .....	£1,568
Band 6 .....	£1,685
Band 7 .....	£1,802

## EFA3T 3 Seats/1 Table Full Back

Band 1 .....	£1,282
Band 2 .....	£1,354
Band 3 .....	£1,488
Band 4 .....	£1,602
Band 5 .....	£1,721
Band 6 .....	£1,837
Band 7 .....	£1,955

## EFA4 4 Seats Full Back

Band 1 .....	£1,499
Band 2 .....	£1,598
Band 3 .....	£1,772
Band 4 .....	£1,929
Band 5 .....	£2,086
Band 6 .....	£2,239
Band 7 .....	£2,397

## EQA2 2 Seats 3/4 Back

Band 1 .....	£690
Band 2 .....	£720
Band 3 .....	£769
Band 4 .....	£814
Band 5 .....	£861
Band 6 .....	£906
Band 7 .....	£953

## EQA2T 2 Seats/1 Table 3/4 Back

Band 1 .....	£831
Band 2 .....	£860
Band 3 .....	£911
Band 4 .....	£956
Band 5 .....	£1,003
Band 6 .....	£1,050
Band 7 .....	£1,093

## EQA3 3 Seats 3/4 Back

Band 1 .....	£932
Band 2 .....	£975
Band 3 .....	£1,052
Band 4 .....	£1,121
Band 5 .....	£1,191
Band 6 .....	£1,258
Band 7 .....	£1,325

## EQA3T 3 Seats/1 Table 3/4 Back

Band 1 .....	£1,070
Band 2 .....	£1,116
Band 3 .....	£1,193
Band 4 .....	£1,261
Band 5 .....	£1,330
Band 6 .....	£1,399
Band 7 .....	£1,466

## EQA4 4 Seats 3/4 Back

Band 1 .....	£1,170
Band 2 .....	£1,229
Band 3 .....	£1,331
Band 4 .....	£1,423
Band 5 .....	£1,515
Band 6 .....	£1,604
Band 7 .....	£1,699



# INTRODUCTION

## TECHNICAL INFORMATION



# BEAM SEATING SPECIFICATION

## TECHNICAL INFORMATION

Please circle required configuration and forward to our Sales Dept. with official order.  
Please note only certain ranges are available with five seats.

**S** = Seat

**T** = Table

Y or N = Arm (Yes or No)

5 Seat or 4 Seat/1 Table



Front of unit.

4 Seat or 3 Seat/1 Table

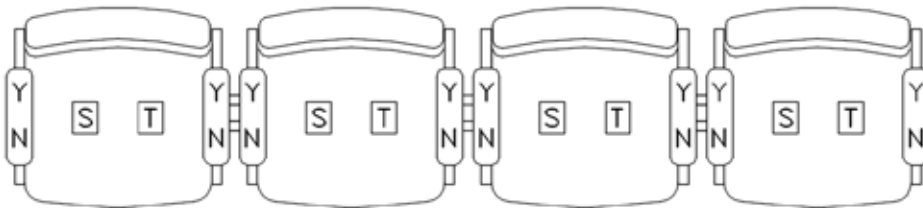

Front of unit.

3 Seat or 2 Seat/1 Table



Front of unit.

2 Seat

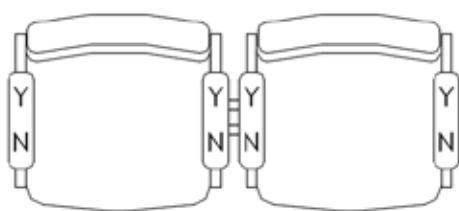

Front of unit.

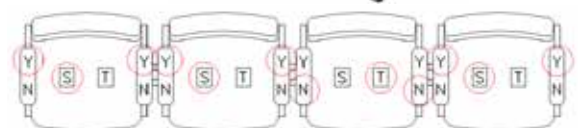

Example

# GALLEN DIMENSIONS

## TECHNICAL INFORMATION

- Available with optional fitted service modules where shown.
- Each module contains 1x UK power outlet and 1x twin USB fast charge outlet. Supplied with 3m lead to UK plug.
- Suffix code with 'P' to specify sofa with service module.

Additional Information  
All dimensions are approximate and should be used as a guide only.

● Denotes position of service module.

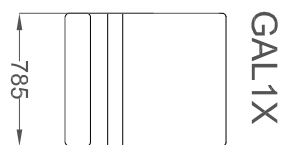
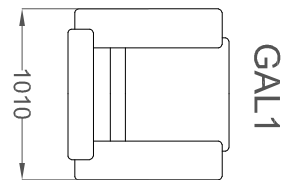
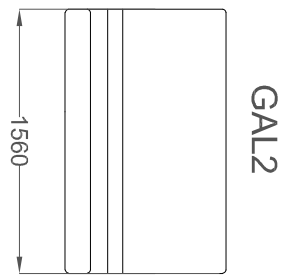
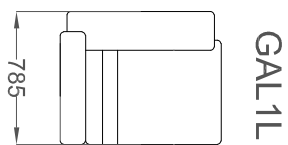
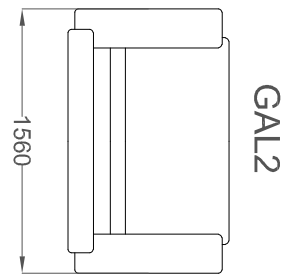
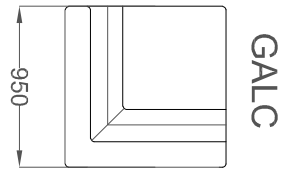
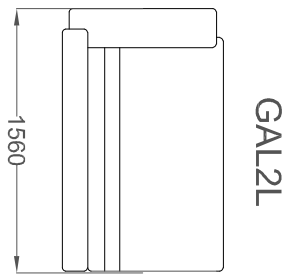
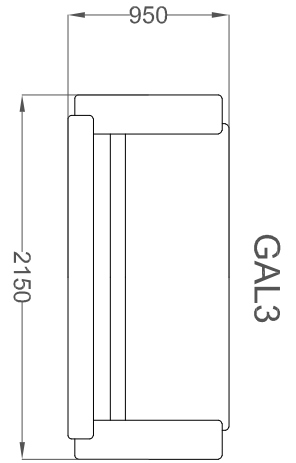
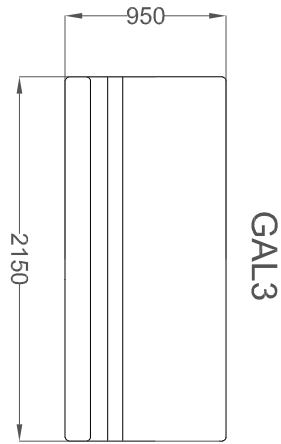
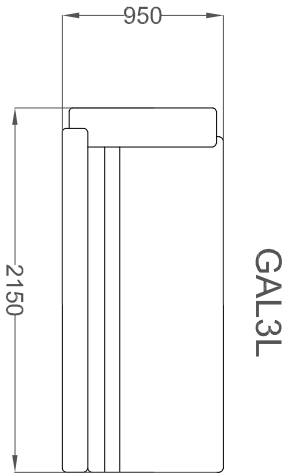



# TAKE UP BOOTH DIMENSIONS

## TECHNICAL INFORMATION

A variation of our high-back Take Up sofa system.

- All connector walls are supplied with concealed fixings for TV bracket or table use.
- Tables are supplied with square flat bases and fixing brackets.

### Additional Information

All dimensions are in millimetres (mm), are approximate and should be used as a guide only.

### Unit Side Views

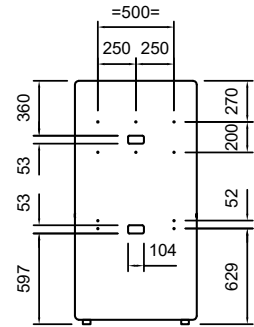
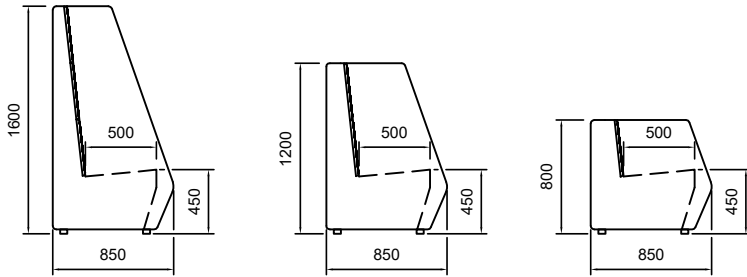

1600 High Connector Wall fixings & cut out positions.

4 User Unit Plan View

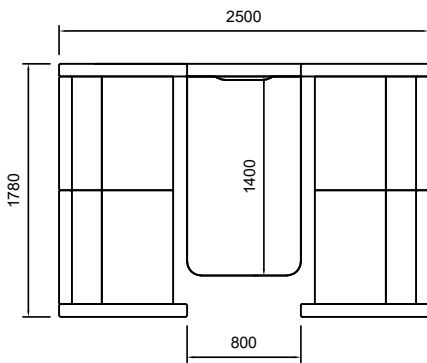

2 User Unit Plan View

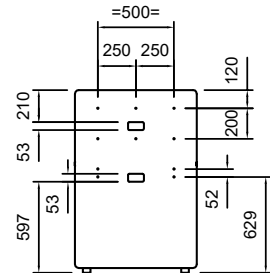
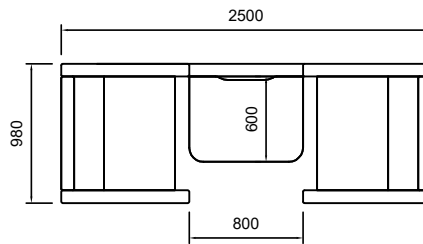

1200 High Connector Wall fixings & cut out positions.

2 User R/Hand Unit Plan View

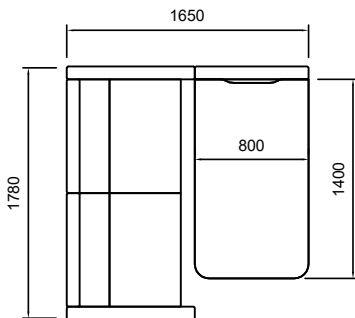

1 User R/Hand Unit Plan View

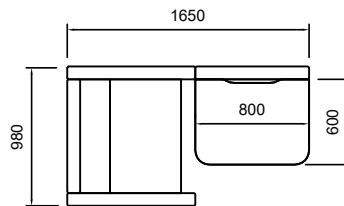

2 User L/Hand Unit Plan View

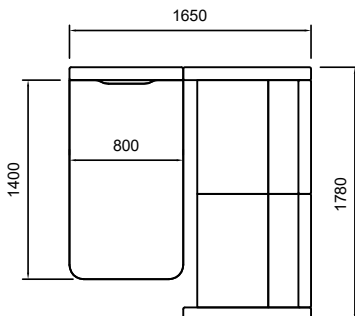

1 User L/Hand Unit Plan View

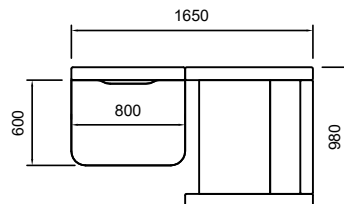

# SEATING DIMENSIONS

## TECHNICAL INFORMATION

<b>Adlington</b>	AO/4	AO/4A2	AO/4A8	AO/9	AO/9A2	AO/9A8	AOC	AOC/A2	AOD/4	AOD/4A2
OA Height:	970-1200	970-1200	970-1200	970-1200	970-1200	970-1200	990	990	1125 - 1495	1125 - 1495
OA Width:	640	640	640	640	640	640	490	580	640	640
OA Depth:	640	640	640	640	640	640	600	600	640	640
OA Arm Height:	-	575-705	645-820	-	575-705	645-820	-	685	-	725 - 1090
Seat Height:	480-585	480-585	480-585	480-585	480-585	480-585	495	495	640-890	640-890
Seat Width:	490	490	490	490	490	490	490	490	490	490
Seat Depth:	465	465	465	465	465	465	465	465	465	465

<b>Adlington</b>	AO/4A13	AO/9A13
OA Height:	970-1200	970-1200
OA Width:	640	640
OA Depth:	640	640
OA Arm Height:	605-775	605-775
Seat Height:	480-585	480-585
Seat Width:	490	490
Seat Depth:	465	465

<b>Adlington Mesh</b>	AM/4	AM/4A2	AM4A8	AM/9	AM/9A2	AM/9A8	AMD/4	AMD/4A2
OA Height:	1015-1245	1015-1245	1015-1245	1015-1245	1015-1245	1015-1245	1125 - 1495	1125 - 1495
OA Width:	640	640	640	640	640	640	640	640
OA Depth:	640	640	640	640	640	640	640	640
OA Arm Height:	-	575-705	645-820	-	575-705	645-820	-	725-1090
Seat Height:	480-585	480-585	480-585	480-585	480-585	480-585	640-890	640-890
Seat Width:	490	490	490	490	490	490	490	490
Seat Depth:	465	465	465	465	465	465	465	465

<b>Adore</b>	AD1	AD2	AD3	AD5	AD11	AD12	AD13	AD14
OA Height:	820	700	950	820	790	925	800	855
Seat Height:	400	400	760	460	430	460	435	495
OA Width:	660	660	500	570	580	580	580	580
OA Depth:	560	560	480	530	600	600	600	600

<b>Alvier Wooden Leg</b>	NS1BW	NS2BW	NS1HW	NS2HW	NS1W	NS2W	NS2PBW	NS2PHW
OA Height:	750	750	830	830	450	450	750	830
Seat Height:	450	450	450	450	450	450	450	450
OA Width:	980	1600	980	1600	980	1600	1600	1600
OA Depth:	680	680	680	680	680	680	680	680

<b>Alvier Sled Leg</b>	NS1BS	NS2BS	NS1HS	NS2HS	NS1S	NS2S	NS2PBS	NS2PHS
OA Height:	750	750	830	830	450	450	750	830
Seat Height:	450	450	450	450	450	450	450	450
OA Width:	980	1600	980	1600	980	1600	1600	1600
OA Depth:	680	680	680	680	680	680	680	680

<b>Alvier Tube Leg</b>	NS1BM	NS2BM	NS1HM	NS2HM	NS1M	NS2M	NS2PBM	NS2PHM
OA Height:	750	750	830	830	450	450	750	830
Seat Height:	450	450	450	450	450	450	450	450
OA Width:	980	1600	980	1600	980	1600	1600	1600
OA Depth:	680	680	680	680	680	680	680	680

<b>Atrium</b>	ATF1W	ATF2W	ATF1	ATF2
OA Height:	880	880	880	880
Seat Height:	460	460	460	460
OA Width:	600	1200	600	1200
OA Depth:	610	610	610	610

<b>Betibo</b>	TIB1	TIB1A	TIB2
OA Height:	820	820	910
OA Width:	510	510	500
OA Depth:	500	500	490
Seat Height:	450	450	775
Seat Width:	460	470	400
Arm Height:	N/A	650	N/A

<b>Betsy</b>	BETS	BET4	BET4W	BETP	BETPW	BETZ	BETPZ
OA Height:	790	702-802	760-860	790	850	790	790
Seat Height:	480	392-492	450-550	480	540	480	480
OA Width:	650	650	650	650	650	650	650
OA Depth:	610	610	610	610	610	610	610

<b>Betsy Sofa</b>	BET2Z	BET2S
OA Height:	800	800
Seat Height:	470	470
OA Width:	1240	1240
OA Depth:	670	670

<b>Bretten</b>	BRE1	BREHS
OA Height:	825	1070
OA Width:	480	480
OA Depth:	505	505
Seat Height:	450	760

# SEATING DIMENSIONS

## TECHNICAL INFORMATION

### Bromley 24/7

	AXR24/7	AXR24/7A22	AX24/7	AX24/7A22
OA Height:	1205-1360	1205-1360	1015-1175	1015-1175
OA Width:	680	705	680	705
OA Depth:	680	680	680	680
OA Arm Height:	-	610-860	-	610-860
Seat Height:	510-610	510-610	510-610	510-610
Seat Width:	520	520	520	520
Seat Depth:	590	590	590	590

### Cafe/Bistro

	TS20W(SP)	TC4D(SP)	TC34N(SP)	TVR1(SP)	EG04N(SP)	EG04W(SP)	EG05N(SP)	EG05W(SP)
OA Height:	835	850	850	850	850	850	845	845
Seat Height:	460	510	500	500	450	450	450	450
OA Width:	495	490	510	510	510	510	510	510
OA Depth:	445	450	455	455	450	450	450	450

### Chatte

	CH1W	CH2W	CH3W	CH1M	CH2M	CH3M
OA Height:	750	750	750	750	750	750
Seat Height:	430	430	430	430	430	430
OA Width:	720	1360	1830	720	1360	1830
OA Depth:	670	670	670	670	670	670

### Claire

	CY1	CY2	CY3
OA Height:	880	880	880
Seat Height:	420	420	420
OA Width:	920	1360	1910
OA Depth:	900	900	900

### Coso

	COS4	COS4A	COS65	COS75
OA Height:	795	805	820	920
OA Width:	465	565	445	445
OA Depth:	545	545	480	480
Seat Height:	445	445	655	755

### Cubes and Arrows

	ES01	ES01M	ES01C	AR1	AR1M
OA Height:	460	460	460	460	460
Seat Height:	460	460	460	460	460
OA Width:	500	500	500	770	770
OA Depth:	500	500	500	500	500

### Curves, Ovals and Rectangles

	EC2	EC2M	ER2	ER2M	ES02	ES02M
OA Height:	460	460	460	460	460	460
Seat Height:	460	460	460	460	460	460
OA Width:	1200	1200	1200	1200	1230	1230
OA Depth:	500	500	450	450	500	500

### Gallen

	GAL1	GAL2	GAL3	GAL1H	GAL2H	GAL3H
OA Height:	850	850	850	1190	1190	1190
Seat Height:	480	480	480	480	480	480
OA Width:	1010	1560	2150	1010	1560	2150
OA Depth:	950	950	950	950	950	950

### Garo

	KARG1
OA Height:	820
OA Width:	480
OA Depth:	470
Seat Height:	460

### GC5

	GC5B1	GC5B2
OA Height:	850	850
OA Width:	455	455
OA Depth:	680	680
Seat Height:	640	640

### GC7

	GC7A1	GC7B1	GC7C1	GC7C2	GC7D1	GC7D2	GC7E1	GC7E2
OA Height:	855	855	855	900	790-900	835-945	700-900	835-945
OA Width:	598	598	650	650	650	650	650	650
OA Depth:	540	540	610	610	610	610	610	610
Seat Height:	465	465	465	510	400-510	445-555	400-510	445-555

### GD2

	GD2A1	GD2A2	GD2A5	GD2A6	GD2B1	GD2B2	GD2B5	GD2B6
OA Height:	699	414	699	414	751	462	751	466
OA Width:	455.5	380	1050	1050	400	400	1070	1070
OA Depth:	455.5	380	454.9	380	400	400	400	400
Seat Height:	699	414	699	414	751	462	751	466

### GD3

	GD3B1	GD3B2	GD3B3
OA Height:	800	450	450
OA Width:	360	360	360
OA Depth:	360	360	360
Seat Height:	800	450	450

# SEATING DIMENSIONS

## TECHNICAL INFORMATION

### G Series Fabric

	GSR/7	GS/7	GSC	GSCA
OA Height:	1210-1380	1070-1240	960	960
OA Width:	680	680	530	530
OA Depth:	680	680	525	525
OA Arm Height: -	-	-	-	-
Seat Height:	470-560	470-560	450	450
Seat Width:	490	490	455	455
Seat Depth:	430-470	430-470	460	460

### G Series Mesh

	GSMR/7	GSM/7	GSMC	GSMCA
OA Height:	1210-1380	1070-1240	960	960
OA Width:	680	680	530	53
OA Depth:	680	680	525	525
OA Arm Height: -	-	-	-	-
Seat Height:	470-560	470-560	450	450
Seat Width:	490	490	455	455
Seat Depth:	430-470	430-470	460	460

### Harlequin Executive

	HQHE-SB1	HQME-SB1	HQEC-SB1
OA Height:	1165-1300	950 - 1080	920
OA Width:	650	650	630
OA Depth:	650	650	640
OA Arm Height:	720 - 810	720 - 810	670
Seat Height:	455 - 590	455 - 590	435
Seat Width:	515	515	515
Seat Depth:	470	470	470

### Harlequin Mesh

	HQHM	HQHM/8	HQHM/A13
OA Height:	1100-1250	1100-1250	1100-1250
OA Width:	700	700	700
OA Depth:	700	700	700
OA Arm Height:	-	680-865	640-820
Seat Height:	510-600	510-600	510-600
Seat Width:	500	500	500
Seat Depth:	440	440	440

### Heavy Duty

	110C	120SM	110SWT	LOS1	230	240M	210S	220M	310	320M
OA Height:	840	840	840	840	865	865	860	860	855	860
OA Width:	510	600	550	526	575	600	585	600	575	590
OA Depth:	550	550	550	550	615	625	615	625	575	575
OA Arm Height:	-	620	-	-	-	630	-	630	-	625
Seat Height:	450	450	450	450	485	485	465	475	485	485
Seat Width:	460	460	460	460	515	515	515	515	515	515
Seat Depth:	475	475	475	475	485	485	485	485	485	485

	330	340M	BAR2	BAR3	420M	410S
OA Height:	870	870	860	860	960	960
OA Width:	590	590	700	700	590	575
OA Depth:	575	575	575	575	575	575
OA Arm Height:	-	625	625	625	625	-
Seat Height:	485	485	485	485	485	485
Seat Width:	515	515	625	625	515	515
Seat Depth:	485	485	485	485	485	485

### Hour

	HR1W	HR1N	HR1SW	HR1SN
OA Height:	810	810	1060	1060
OA Width:	540	540	440	440
OA Depth:	540	540	460	460
Seat Height:	460	460	725	725

### Hecta

	HECS	HECW	HECP
OA Height:	1200	1200	1200
OA Width:	820	820	820
OA Depth:	760	760	760
Seat Height:	430	430	430

### Industrial

	INPU/16	INDPU/16	INS/R	INDS/P	INS/P
OA Height:	785-1020	1000-1330	400-505	665-915	580-830
OA Width:	640	640	640	640	640
OA Depth:	640	640	640	640	640
Arm Height:	-	-	-	-	-
Seat Height:	410-525	580-810	400-505	665-810	580-830
Seat Width:	470	460	350	350	350
Seat Depth:	420	415	350	350	350

### Izzy

	IZH1(FA)	IZH2(FA)	IZLO1(FA)	IZLO2(FA)
OA Height:	1180	1180	800	800
Seat Height:	460	460	460	460
OA Width:	760	1400	760	1400
OA Depth:	770	770	770	770

### Izzy Lite

	IZLT	IZLTS	IZLTW
OA Height:	800	800	782
Seat Height:	460	460	442
OA Width:	620	620	620
OA Depth:	570	570	570

# SEATING DIMENSIONS

## TECHNICAL INFORMATION

<b>Kast</b>						
	KASFMA2	KASFMA1	KASVMA2	KASLBFMA2	KASLBFMA1	KASLBVMA2
OA Height:	1030-1140	1020-1130	1060	1018 – 1140	1020 – 1130	1048
Seat Height:	530	530	530	530	530	530
OA Width:	640	645	640	640	645	640
OA Depth:	470-570	460-550	490	470-570	460-550	490

<b>Kempton</b>			
	K1	KA	KWMA
OA Height:	800	800	800
OA Width:	510	600	625
OA Depth:	565	565	675
OA Arm Height:	-	670	670
Seat Height:	460	460	460
Seat Width:	460	460	460
Seat Depth:	450	450	450

<b>Klyro High Back</b>							
	KLY1H8	KLY1H1	KLY1H4	KLY1H2	KLY1H7	KLY1H5	KLY1H3
OA Height:	1040	1060	1030	1060	1060	1060	1060
OA Width:	800	800	800	800	800	800	800
OA Depth:	780	780	780	780	780	780	780
Seat Height:	410	430	400	430	430	430	430

	KLY2H4	KLY2H2	KLY2H3	KLY2H7
OA Height:	1060	1060	1060	1060
OA Width:	1440	1440	1440	1440
OA Depth:	780	780	780	780
Seat Height:	430	430	430	430

<b>Klyro Low Back</b>							
	KLY1L8	KLY1L1	KLY1L4	KLY1L2	KLY1L7	KLY1L5	KLY1L3
OA Height:	800	820	790	820	820	820	820
OA Width:	800	800	800	800	800	800	800
OA Depth:	780	770	770	770	770	770	770
Seat Height:	410	430	400	430	430	430	430

	KLY2L4	KLY2L2	KLY2L3	KLY2L7
OA Height:	820	820	820	820
OA Width:	1440	1440	1440	1440
OA Depth:	770	770	770	770
Seat Height:	430	430	430	430

<b>Klyro Meeting Chair</b>								
	KLY1AR8	KLY1AR1	KLY1AR7	KLY1AR5	KLY1AR6	KLYP1	KLYP21	KLYP5
OA Height:	870	870	870	870	870	410	410	410
OA Width:	580	580	580	580	580	550	550	550
OA Depth:	630	630	630	630	630	550	550	550
Seat Height:	490	490	490	490	490	N/A	N/A	N/A

<b>LC11 Chrome</b>				
	LC11A1	LC11A3	LC11B1	LC11C1
OA Height:	830	840	820	820
OA Width:	535	490	540	540
OA Depth:	525	510	520	520
Seat Height:	450	460	450	450

<b>LC11 Sled</b>				
	LC11M1	LC11M2	LC11N1	LC11N2
OA Height:	1030	1040	1180	1190
OA Width:	480	480	500	500
OA Depth:	550	550	530	530
Seat Height:	650	660	800	810

<b>LC11 Star</b>				
	LC11F3	LC11G3	LC11Q3	LC11Q4
OA Height:	850	850	800-910	800-910
OA Width:	490	490	611	610
OA Depth:	500	500	570	570
Seat Height:	460	460	420-530	420-530

<b>LC11 Stool</b>						
	LC11K1	LC11K2	LC11L1	LC11L2	LC11P1	LC11P2
OA Height:	1050	1060	1200	1210	1030-1220	1040-1230
OA Width:	470	470	500	500	440	440
OA Depth:	500	500	500	500	490	490
Seat Height:	650	660	800	810	650-840	660-850

<b>LC11 Wood</b>		
	LC11H1	LC11H2
OA Height:	830	840
OA Width:	445	445
OA Depth:	510	510
Seat Height:	450	460

<b>LC17</b>	
	LC17A
OA Height:	790
OA Width:	580
OA Depth:	575
Seat Height:	460

# SEATING DIMENSIONS

## TECHNICAL INFORMATION

<b>LC18</b>		
	<b>LC18C</b>	<b>LC18D</b>
OA Height:	740	890
OA Width:	450	450
OA Depth:	500	500
Seat Height:	670	820

<b>LG1 Chrome</b>			
	<b>LG1A1</b>	<b>LG1B1</b>	<b>LG1G1</b>
OA Height:	815	810	970
OA Width:	580	580	525
OA Depth:	500	520	500
Seat Height:	450	450	760

<b>LG1 Plastic</b>	
	<b>LG1E1</b>
OA Height:	815
OA Width:	510
OA Depth:	480
Seat Height:	450

<b>LG1</b>				
	<b>LG1A1</b>	<b>LG1B1</b>	<b>LG1G1</b>	<b>LG1E1</b>
OA Height:	815	810	970	815
OA Width:	580	580	525	510
OA Depth:	500	520	500	480
Seat Height:	450	450	760	450

<b>LG4 Chrome</b>				
	<b>LG4A1</b>	<b>LG4B1</b>	<b>LG4J1</b>	<b>LG4M1</b>
OA Height:	825	825	1015	1130
OA Width:	510	480	510	520
OA Depth:	510	490	490	540
Seat Height:	450	450	655	760

<b>LG4 Plastic</b>	
	<b>LG4E1</b>
OA Height:	820
OA Width:	450
OA Depth:	490
Seat Height:	450

<b>LG4 Wood</b>				
	<b>LG4C1</b>	<b>LG4K1</b>	<b>LG4C1UPH</b>	<b>LG4L1UPH</b>
OA Height:	835	1065	835	1065
OA Width:	460	470	460	470
OA Depth:	460	480	460	480
Seat Height:	450	680	450	680

<b>LG10</b>		
	<b>LG10A</b>	<b>LG10B</b>
OA Height:	780	780
OA Width:	920	1680
OA Depth:	820	820
Seat Height:	470	470
Seat Width:	660	1440
Seat Depth:	660	660

<b>LG27</b>	
	<b>LG27</b>
OA Height:	460
OA Width:	590
OA Depth:	480
Seat Height:	460

<b>LG30</b>				
	<b>LG30A</b>	<b>LG30ST</b>	<b>LG30HA</b>	<b>LG30AT</b>
OA Height:	850	855	1100	850
OA Width:	585	620	580	585
OA Depth:	605	480	450	605
Seat Height:	407	430	750	407

<b>LG31</b>							
	<b>LG31C</b>	<b>LG31LS</b>	<b>LG31HS</b>	<b>LG31CUS</b>	<b>LG31LSUS</b>	<b>LG31HSUS</b>	
OA Height:	790	800	900	790	800	900	790
OA Width:	460	460	480	460	460	480	470
OA Depth:	490	495	500	490	495	500	470
Seat Height:	480	650	750	480	650	750	470

<b>LG32</b>		
	<b>LG32A</b>	<b>LG32B</b>
OA Height:	760	950
OA Width:	460	450
OA Depth:	560	480
Seat Height:	490	770

<b>LG33</b>		
	<b>LG33A</b>	<b>LG33B</b>
OA Height:	790	790
OA Width:	590	590
OA Depth:	570	570
Seat Height:	450	450

# SEATING DIMENSIONS

## TECHNICAL INFORMATION

<b>LS24</b>										
	LS24A1	LS24A2	LS24B1	LS24B2	LS24C1	LS24C2	LS24D1	LS24D2	LS24E1	LS24E2
OA Height:	710	860	710	860	710	860	710	860	710	860
OA Width:	610	610	1210	1210	1710	1710	1045	1045	1741	1741
OA Depth:	670	670	670	670	670	670	900	900	1256	1256
Seat Height:	460	460	460	460	460	460	460	460	460	460

<b>LS25</b>				
	LS25A	LS25B	LS25C	LS25D
OA Height:	800	810	780	880
OA Width:	460	615	420	420
OA Depth:	550	550	490	490
Seat Height:	430	430	630	730
Seat Width:	-	460	-	-

<b>LS36</b>				
	LS36A	LS36B	LS36C	LS36D
OA Height:	790	800	810	1105
OA Width:	540	540	560	544
OA Depth:	525	525	525	525
Seat Height:	450	450	450	755

<b>LS37</b>	
	LS37A
Seat:	300ø
Base:	400
Seat Height:	590-840

<b>Lynstock Choice</b>				
	910	910RM	910LM	910AM
OA Height:	830	830	830	830
OA Width:	590	590	590	590
OA Depth:	730	730	730	730
Seat Height:	410	410	410	410

<b>Masca</b>										
	MASC2	MASC4	MASC11	MASC12	MASC13	MASC14	MASC21	MASC22	MASC23	MASC24
OA Height:	1020	770	790-930	800-910	835	900	1020-1160	1030-1140	1065	1130
Seat Height:	440	440	420-550	430-540	470	540	420-550	430-540	470	540
OA Width:	595	595	630	630	630	630	630	630	630	630
OA Depth:	580	580	680	680	680	680	680	680	680	680

<b>Meeting Chair</b>										
	M1	MA	MW	M1SP	MASP	MWSP	M1SBP	MASBP	MWSBP	
OA Height:	760	760	760	760	760	760	760	760	760	
OA Width:	465	525	525	465	525	525	465	525	525	
OA Depth:	525	525	525	525	525	525	525	525	525	
OA Arm Height:	-	645	-	-	645	-	-	645	-	
Seat Height:	440	440	440	440	440	440	440	440	440	
Seat Width:	425	425	425	425	425	425	425	425	425	
Seat Depth:	440	440	440	440	440	440	440	440	440	

<b>Meroux</b>			
	MER1	MERLS	MERHS
OA Height:	835	455	770
OA Width:	450	385	440
OA Depth:	540	385	440
Seat Height:	450	455	770

<b>Metric Executive</b>				
	MCFB	MCHB	M4FB	M4HB
OA Height:	940	835	905	835
OA Width:	565	565	565	565
OA Depth:	630	630	575	575
OA Arm Height:	645	645	635	635
Seat Height:	460	460	460	460
Seat Width:	505	505	505	505
Seat Depth:	470	470	470	470

<b>Metric Plus</b>							
	MSHBM	M4HBM	MCHBM	MCHBPL	M4HBPL	MSFB	MSHB
OA Height:	815-905	835	835	835	835	920-1010	815-905
OA Width:	640	565	565	565	565	640	640
OA Depth:	640	630	630	630	630	640	640
OA Arm Height:	645	645	945	645	645	625-715	625-715
Seat Height:	460	460	460	460	460	440-530	440-530
Seat Width:	505	505	505	505	505	505	505
Seat Depth:	470	470	470	470	470	470	470

<b>Mod</b>		
	MOD1	MODA
OA Height:	850	850
Seat Height:	510	510
OA Width:	530	530
OA Depth:	435	435

<b>Monoko</b>		
	MON1S	MON2S
OA Height:	800	800
OA Width:	680	1360
OA Depth:	815	815
OA Arm Height:	630	630
Seat Height:	460	460
Seat Width:	600	1280
Seat Depth:	800	800

# SEATING DIMENSIONS

## TECHNICAL INFORMATION

### Moons & Rounds (Rounds)

	R500	R500M	R500C	R800	R800M	R800C	R1000	R1000M	M500	M500M
OA Height:	460	460	460	460	460	460	460	460	460	460
Seat Height:	460	460	460	460	460	460	460	460	460	460
OA Width:	500	500	500	800	800	800	1000	1000	500	500
OA Depth:	500	500	500	800	800	800	1000	1000	500	500

### Moons & Rounds (Moons)

	M500C	M800	M800M	M800C	M1000	M1000M
OA Height:	460	460	460	460	460	460
Seat Height:	460	460	460	460	460	460
OA Width:	500	800	800	800	1000	1000
OA Depth:	500	800	800	800	1000	1000

### Motile

	MOTSF	MOT4BR
OA Height:	820	860
Seat Height:	440	450
OA Width:	650	670
OA Depth:	650	670

### Move Up

	MU/7	MU/7A23	MU/7A24	MU/7A25	MUM/7	MUM/7A23	MUM/7A24	MUM/7A25	MUC	MUMC
OA Height:	975-1150	975-1150	975-1150	975-1150	1030-1200	1030-1200	1030-1200	1030-1200	1015	1070
OA Width:	680	680	680	680	680	680	680	680	520	520
OA Depth:	680	680	680	680	680	680	680	680	600	600
OA Arm Height: -	-	610	610-760	610-770	-	610	610-760	610-770	-	-
Seat Height:	470-560	470-560	470-560	470-560	470-560	470-560	470-560	470-560	500	500
Seat Width:	490	490	490	490	490	490	490	490	520	520
Seat Depth:	430-470	430-470	430-470	430-470	430-470	430-470	430-470	430-470	490	490

### Nao

	NAO1	NAO2	NAO3
OA Height:	780	780	780
Seat Height:	450	450	450
OA Width:	900	1400	1900
OA Depth:	720	720	720

### Neos

	NPES	NPE4	NPE4W	NPEP	NPEPW
OA Height:	790	780-790	820-920	790	850
Seat Height:	460	40-530	460-560	460	530
OA Width:	490	650	650	550	550
OA Depth:	490	650	650	550	550

### Newton

	650A	651	651A	651AR	651AL	652	652A
OA Height:	1160	950	950	950	950	830	830
OA Width:	635	590	635	635	635	590	635
OA Depth:	760	700	700	700	700	675	675
Seat Height:	480	480	480	480	480	480	480

### Oli

	OL4	OLA4	OLC	OL4SP	OLA4SP	OLCSP	OL4SBP	OLA4SBP	OLCSBP	OLS(SP/SBP)
OA Height:	845	845	845	845	845	845	845	845	845	1150
OA Width:	490	500	540	500	490	540	500	490	540	540
OA Depth:	535	535	510	535	535	510	535	535	510	550
OA Arm Height:	-	670	-	-	670	-	-	670	-	-
Seat Height:	460	460	460	460	460	460	460	460	460	750
Seat Width:	440	440	440	440	440	440	440	440	440	440
Seat Depth:	455	455	455	455	455	455	455	455	455	455

### Onio

	ONIOU1
OA Height:	685
OA Width:	720
OA Depth:	630
Seat height:	390

### Opso

	OP14BENSEAT	OP4WAYTAB
OA Height:	525	230
OA Width:	1400	460
OA Depth:	420	460

### Osana Bench

	KB1SF	KB2SF	KB3SF	KBCS	KBSS	KBPC	KBTS
OA Height:	320	320	320	450	450	90	N/A
OA Width:	600	1200	1800	600	600	600	600
OA Depth:	600	600	600	600	600	600	600

### Oscar

	No Headrest	Headrest
OA Height:	960-1060	1140-1240
OA Width:	650-710	650-710
OA Depth:	700	700
OA Arm Height:	260-340	260-340
Seat Height:	410-510	410-510
Seat Width:	480	480
Seat Depth:	460	460



# SEATING DIMENSIONS

## TECHNICAL INFORMATION

### Outwood

	OR1	ORA	ORR(L)
OA Height:	820	820	820
Seat Height:	430	430	430
OA Width:	610	810	710
OA Depth:	750	750	750

### Oxy

	OXY1	OXY2	OXY3
OA Height:	680	680	680
Seat Height:	430	430	430
OA Width:	840	1400	1940
OA Depth:	760	760	760

### Pennine

	XO1	XO2	XO3	XO4	XO5	XO6	XO7	XO8
OA Height:	865	865	855	855	855	865	865	865
OA Width:	520	520	545	545	545	545	545	545
OA Depth:	605	605	555	555	555	555	555	555
Seat Height:	465	465	370	370	370	370	440	440

### Platinum Ergo

	PLH/3	PLH/3A2	PLH/3A8	PLH/3A13	PLM/3	PLM/3A2	PLM/3A8	PLM/3A13	PLHXC
OA Height:	950-1140	950-1140	950-1140	950-1140	920-1120	920-1120	920-1120	920-1120	990
OA Width:	640	640	640	640	640	640	640	640	525
OA Depth:	640	640	640	640	640	640	640	640	600
OA Arm Height:	-	705-795	680-865	640-820	-	705-795	680-865	640-820	-
Seat Height:	420-540	420-540	420-540	420-540	420-540	420-540	420-540	420-540	480
Seat Width:	515	515	515	515	515	515	515	515	515
Seat Depth:	490	490	490	490	490	490	490	490	490

	PLMD/8	PLMD/8A2
OA Height:	1090-1460	1090-1460
OA Width:	640	640
OA Depth:	640	640
OA Arm Height:	-	830-1090
Seat Height:	640-890	640-890
Seat Width:	515	515
Seat Depth:	490	490

### Platinum Mesh

	PMH/3	PMH/3A2	PMH/3A8	PMH/3A13	PMH/3A4D
OA Height:	1080-1320	1080-1320	1080-1320	1080-1320	1080-1320
OA Width:	660	660	660	660	660
OA Depth:	760	760	760	760	760
OA Arm Height:	660-840	660-840	660-840	660-840	660-840
Seat Height:	440-540	440-540	440-540	440-540	440-540
Seat Width:	520	520	520	520	520
Seat Depth:	470	470	470	470	470

### Platinum Plus Squared

	PPSH/3	PPSH/3A2	PPSH/3A8	PPSH/3A13	PPSH/3A4D	PPSM/3	PPSM/3A2	PPSM/3A8	PPSM/3A13	PPSM/3A4D
OA Height:	950-1140	950-1140	950-1140	950-1140	950-1140	920-1120	920-1120	920-1120	920-1120	920-1120
OA Width:	680	680	680	680	680	680	680	680	680	680
OA Depth:	680	680	680	680	680	680	680	680	680	680
OA Arm Height:	-	705-795	680-865	640-820	640-820	-	705-795	680-865	640-820	640-820
Seat Height:	440-540	440-540	440-540	440-540	440-540	440-540	440-540	440-540	440-540	440-540
Seat Width:	515	515	515	515	515	515	515	515	515	515
Seat Depth:	490	490	490	490	490	490	490	490	490	490

	PPSHXC	PPSMXC	PPSMD/8	PPSMD/8A2
OA Height:	990	930	1140-1395	1140-1395
OA Width:	525	525	680	680
OA Depth:	600	600	680	680
OA Arm Height:	-	-	-	830-1090
Seat Height:	480	480	680-940	680-940
Seat Width:	515	515	515	515
Seat Depth:	490	490	490	490

### Platinum Plus Round

	PPRBH/3	PPRBH/3A2	PPRBH/3A8	PPRBH/3A13	PPRBH/3A4D	PPRBM/3	PPRBM/3A2	PPRBM/3A8	PPRBM/3A13	PPRBM/3A4D
OA Height:	950-1140	950-1140	950-1140	950-1140	950-1140	950-1120	950-1120	950-1120	950-1120	950-1120
OA Width:	680	680	680	680	680	680	680	680	680	680
OA Depth:	680	680	680	680	680	680	680	680	680	680
OA Arm Height:	-	705-795	680-865	640-820	640-820	-	705-795	680-865	640-820	640-820
Seat Height:	440-540	440-540	440-540	440-540	440-540	440-540	440-540	440-540	440-540	440-540
Seat Width:	515	515	515	515	515	515	515	515	515	515
Seat Depth:	490	490	490	490	490	490	490	490	490	490

	PPRBHXC	PPRBMXC	PPRMD/8	PPRMD/8A2
OA Height:	990	890	1140-1395	1140-1395
OA Width:	525	525	680	680
OA Depth:	600	600	680	680
OA Arm Height:	-	-	-	830-1090
Seat Height:	480	480	680-940	680-940
Seat Width:	515	515	515	515
Seat Depth:	490	490	490	490

### Platinum Squared

	PSQH/3	PSQH/3A2	PSQH/3A8	PSQH/3A13	PSQM/3	PSQM/3A2	PSQM/3A8	PSQM/3A13	PSQHXC
OA Height:	970-1160	970-1160	970-1160	970-1160	940-1140	940-1140	940-1140	940-1140	970
OA Width:	640	640	640	640	640	640	640	640	525
OA Depth:	640	640	640	640	640	640	640	640	600
OA Arm Height:	-	705-795	680-865	640-820	-	705-795	680-865	640-820	-
Seat Height:	420-540	420-540	420-540	420-540	420-540	420-540	420-540	420-540	480
Seat Width:	515	515	515	515	515	515	515	515	515
Seat Depth:	490	490	490	490	490	490	490	490	490

# SEATING DIMENSIONS

## TECHNICAL INFORMATION

### Platinum Squared

	PSQMD/8	PSQMD/8A2
OA Height:	1130-1460	1130-1460
OA Width:	640	640
OA Depth:	640	640
OA Arm Height:	-	830-1090
Seat Height:	640-890	640-890
Seat Width:	515	515
Seat Depth:	490	490

### Qus

	QUSL	QUS4	QUSRT	QUSLT	QUSC	QUSS8	QUSW
OA Height:	770	770	840	840	760	1000	810
OA Width:	460	460	460	460	460	460	460
OA Depth:	495	495	495	495	495	495	495
Seat Height:	440	440	440	440	440	630	480

### ReIo

	RELOST1	RELOST2	RELOSW1	RELOSW2
OA Height:	850	880	850	880
OA Width:	825	825	825	825
OA Depth:	875	875	875	875
Seat Height:	450	480	450	480

### Richmond

	RIC1	RIC2	RIC3
OA Height:	790	790	790
Seat Height:	420	420	420
OA Width:	800	1400	2150
OA Depth:	1020	1020	1020

### Santis Ergo

	SIE/7	SIE/7A1	SIE/7A8	SIE/7A13	SIE/7A4D
OA Height:	1100-1180	1100-1180	1100-1180	1100-1180	1100-1180
OA Width:	680	680	680	680	680
OA Depth:	680	680	680	680	680
OA Arm Height:	-	720-810	680-865	640-820	640-820
Seat Height:	490-600	490-600	490-600	490-600	490-600
Seat Width:	515	515	515	515	515
Seat Depth:	490	490	490	490	490

### Santis Squared

	SIS/7	SIS/7A1	SIS/7A8	SIS/7A13	SIS/7A4D
OA Height:	1070-1150	1070-1150	1070-1150	1070-1150	1070-1150
OA Width:	680	680	680	680	680
OA Depth:	680	680	680	680	680
OA Arm Height:	-	720-810	670-840	640-820	640-820
Seat Height:	490-600	490-600	490-600	490-600	490-600
Seat Width:	515	515	515	515	515
Seat Depth:	490	490	490	490	490

### SJX Plastic

	SJXP1	SJXPA	SJXPRT/PLT	SJX1P1W	SJXPAW	SJXPRTW/PLTW	SJXCP1	SJXCPA	SJXCPRT/CPLT
QA Height:	800	800	800	800	800	800	840	840	840
OA Width:	560	590	630	560	590	630	560	590	630
OA Depth:	550	550	550	550	550	550	560	560	560
OA Arm Height:	-	650	650	-	650	650	-	650	650
Seat Height:	455	455	455	455	455	445	480	480	480
Seat Width:	460	460	460	460	460	460	460	460	460
Seat Depth:	470	470	470	470	470	470	470	470	470

### SJX Mesh

	SJXM1	SJXMA	SJXMRT/LT	SJXM1W	SJXMAW	SJXMRTW/LTW	SJXMC	SJXCA	SJXMRT/LT
OA Height:	800	800	800	800	800	800	840	840	840
OA Width:	560	590	630	560	590	630	560	590	630
OA Depth:	550	550	550	550	550	550	560	560	560
OA Arm Height:	-	650	650	-	650	650	-	650	650
Seat Height:	455	455	455	455	455	455	480	480	480
Seat Width:	460	460	460	460	460	460	460	460	460
Seat Depth:	470	470	470	470	470	470	470	470	470

### SJX Fully Upholstered

	SJX1	SJXA	SJXRT/LT	SJX1W	SJXAW	SJXRTW/LTW	SJXC	SJXCA	SJXCRT/LT
OA Height:	800	800	800	800	800	800	840	840	840
OA Width:	560	590	630	560	590	630	560	590	630
OA Depth:	550	550	550	550	550	550	560	560	560
OA Arm Height:	-	650	650	-	650	650	-	650	650
Seat Height:	455	455	455	455	455	455	480	480	480
Seat Width:	460	460	460	460	460	460	460	460	460
Seat Depth:	470	470	470	470	470	470	470	470	470

### SJX Upholstered Seat

	SJX1SP	SJXASP	SJXRTSP/LTSP	SJX1SPW	SJXASPW	SJXRTSPW/LTSPW	SJXCSP	SJXCASP	SJXCRTSP/LTSP
OA Height:	800	800	800	800	800	800	840	840	840
OA Width:	560	590	630	560	590	630	560	590	630
OA Depth:	550	550	550	550	550	550	560	560	560
OA Arm Height:	-	650	650	-	650	650	-	650	650
Seat Height:	455	455	455	455	455	455	480	480	480
Seat Width:	460	460	460	460	460	460	460	460	460
Seat Depth:	470	470	470	470	470	470	470	470	470

### Solent

	SOL1W	SOL2W	SOL3W	SOL1M	SOL2M	SOL3M
OA Height:	830	830	830	830	830	830
Seat Height:	450	450	450	450	450	450
OA Width:	690	1370	1780	690	1370	1780
OA Depth:	830	830	830	830	830	830

# SEATING DIMENSIONS

## TECHNICAL INFORMATION

### Sound Station

	<b>SST1</b>
OA Height:	1578
Seat Height:	415
OA Width:	1276
OA Depth:	665

### Steps Compact Castor

	<b>STCDM</b>	<b>STCDMAU</b>	<b>STCDMAW</b>
OA Height:	843	843	843
Seat Height:	447	447	447
OA Width:	495	615	615
OA Depth:	675	675	675

### Steps Compact Sled

	<b>STCBA</b>	<b>STCBAU</b>	<b>STCBAW</b>
OA Height:	850	850	850
Seat Height:	475	475	475
OA Width:	576	615	615
OA Depth:	680	680	680

### Steps Compact Swivel

	<b>STCS</b>	<b>STCSAU</b>	<b>STCSAW</b>
OA Height:	843	843	843
Seat Height:	447	447	447
OA Width:	495	615	615
OA Depth:	675	675	675

### Steps Compact 4 Star

	<b>STCDG</b>	<b>STCDGAU</b>	<b>STCDGAW</b>
OA Height:	843	843	843
Seat Height:	447	447	447
OA Width:	495	615	615
OA Depth:	675	675	675

### Steps Lounge Castor

	<b>STLDM</b>	<b>STLDMAU</b>	<b>STLDMAW</b>	<b>STLDMAHU</b>	<b>STLDMAHW</b>
OA Height:	1000	1000	1000	1310	1310
Seat Height:	445	445	445	445	445
OA Width:	785	785	785	785	785
OA Depth:	825	825	825	935	935

### Steps Lounge Sled

	<b>STLBA</b>	<b>STLBAU</b>	<b>STLBAW</b>	<b>STLBAHU</b>	<b>STLBAHW</b>
OA Height:	940	940	940	1285	1285
Seat Height:	435	435	435	435	435
OA Width:	660	780	780	780	780
OA Depth:	825	825	825	930	930

### Steps Lounge Swivel

	<b>STLS</b>	<b>STLSAU</b>	<b>STLSAW</b>	<b>STLSAHU</b>	<b>STLSAHW</b>
OA Height:	1000	1000	1000	1310	1310
Seat Height:	445	445	445	445	445
OA Width:	785	785	785	785	785
OA Depth:	825	825	825	935	935

### Steps Lounge 4 Star

	<b>STLDG</b>	<b>STLDGAU</b>	<b>STLDGAW</b>	<b>STLDGAHU</b>	<b>STLDGAHW</b>
OA Height:	1000	1000	1000	1310	1310
Seat Height:	445	445	445	445	445
OA Width:	785	785	785	785	785
OA Depth:	825	825	825	935	935

### Stratt Plus

	<b>STR1W</b>	<b>STR2W</b>	<b>STR3W</b>	<b>R8CURPW</b>	<b>R16CURPW</b>	<b>STR1M</b>	<b>STR2M</b>	<b>STR3M</b>	<b>R8CURPM</b>	<b>R16CURPM</b>
OA Height:	920	920	920	920	920	920	920	920	920	920
Seat Height:	450	450	450	450	450	450	450	450	450	450
OA Width:	660	1260	1750	1130	1910	660	1260	1750	1130	1910
OA Depth:	700	700	700	700	700	700	700	700	700	700

### Take Off Task

	<b>TO20</b>	<b>TO21</b>	<b>TO23</b>	<b>TO24</b>	<b>TO25</b>	<b>TO27</b>	<b>TO28</b>
OA Height:	1060-1280	1060-1280	1060-1280	990-1205	990-1205	990-1205	980
OA Width:	620	620	620	620	620	620	585
OA Depth:	680	680	680	680	680	680	695
OA Arm Height:	-	700-820	680-820	-	700-820	700-820	665
Seat Height:	460 -560	460 -560	460 -560	460 -560	460 -560	460 -560	450
Seat Width:	490	490	490	490	490	490	475
Seat Depth:	460-570	460-570	460-570	460-570	460-570	460-570	460

	<b>ATQZ</b>	<b>ATRZ</b>	<b>A1212Z</b>	<b>A1206Z</b>	<b>A0606Z</b>
OA Height:	450	450	450	450	450
OA Width:	630	1200	1200	1200	630
OA Depth:	630	600	1200	630	630

### Take Off Executive

	<b>TO1</b>	<b>TO2</b>	<b>TO3</b>	<b>TO4</b>	<b>TO5</b>	<b>TO6</b>	<b>TO7</b>	<b>TO8</b>	<b>TO10</b>	<b>TO11</b>
OA Height:	1225-1400	1225-1400	1225-1400	1225-1400	1225-1400	1225-1400	1225-1400	1225-1400	990-1200	990-1200
OA Width:	620	620	620	620	620	620	620	620	620	620
OA Depth:	680	680	680	680	680	680	680	680	680	680
OA Arm Height:	-	700-820	700-790	680-820	-	700-820	700-790	680-820	-	700-820
Seat Height:	460 -560	460 -560	460 -560	460 -560	460 -560	460 -560	460 -560	460 -560	460 -560	460 -560
Seat Width:	490	490	490	490	490	490	490	490	490	490
Seat Depth:	460-570	460-570	460-570	460-570	460-570	460-570	460-570	460-570	460-570	460-570

# SEATING DIMENSIONS

## TECHNICAL INFORMATION

### Take Off Executive

TO12	TO13	TO14	
OA Height:	990-1200	990-1200	965
OA Width:	620	620	600
OA Depth:	680	680	650
OA Arm Height:	700-790	680-820	665
Seat Height:	460 -560	460 -560	490
Seat Width:	490	490	490
Seat Depth:	460-570	460-570	490

### Take Off Lite

	TL12	TL12FB	TL12RB	TL12LB	TL06	TL06FB
OA Height:	460	840	840	840	460	840
Seat Height:	460	460	460	460	460	460
OA Width:	1200	1200	1200	1200	633	633
OA Depth:	633	633	633	633	633	633

### Take Off Plus Low Back

	TP1L	TP2LL	TP2LR	TP3L	TP4L	TP5L	TP6LL	TP6LR	TP7TL	TP3SL
OA Height:	830	830	830	830	830	830	830	830	830	830
Seat Height:	470	470	470	470	470	470	470	470	470	470
OA Width:	2890	3340	3340	1690	2890	2890	2890	2890	2390	1090
OA Depth:	1895	2890	2890	695	695	2140	2140	2140	1690	695

	TP8L	TP11L	TP106TL
OA Height:	830	830	830
Seat Height:	470	470	470
OA Width:	2890	2290	2390
OA Depth:	3340	695	2290

### Take Off Plus High Back

	TP1H	TP2HL	TP2HR	TP3H	TP4H	TP5H	TP6HL	TP6HR	TP7TH	TP3SH
OA Height:	1360	1360	1360	1360	1360	1360	1360	1360	1360	1360
Seat Height:	470	470	470	470	470	470	470	470	470	470
OA Width:	2890	3340	3340	1690	2890	2890	2890	2890	2390	1090
OA Depth:	1895	2890	2890	695	695	2140	2140	2140	1690	695

	TP8H	TP11H	TP106TH	TP92TH	TP92TMH	TP94TMH	TP96TMH
OA Height:	1360	1360	1360	1360	1360	1360	1360
Seat Height:	470	470	470	470	470	470	470
OA Width:	2890	2290	2390	2390	2390	2390	2390
OA Depth:	3340	695	2290	1090	1090	1690	2290

### Take Off Soft Seating

	AS06	ASQ	AS06LB/RB	AS06FB	AS06FLA/FRA	AS06LBA/RBA	AS06TB	AS66FB	AS06FA	AS66
OA Height:	460	460	840	840	840	840	840	840	840	460
Seat Height:	460	460	460	460	460	460	460	460	460	460
OA Width:	1200	640	1200	1200	1400	1400	1400	640	1600	640
OA Depth:	640	640	640	640	640	640	640	640	640	640

### Tiros

	TIR1LB	TIR1HB	TIR2LB	TIR2HB
OA Height:	950	1200	950	1200
OA Width:	910	910	1370	1370
OA Depth:	750	750	750	750
Seat Height:	470	470	470	470
Seat Width:	700	700	1200	1200

### Unoa Booth

	UNOBA1	UNOBA2
OA Height:	1310	1310
OA Width:	1390	2380
OA Depth:	700	1390
Seat Height:	430	430
Seat Width:	1090	1090
Seat Depth:	550	550

### Take Up

	TKULD	TKULL	TKULR	TKULS/ST	TKULCA/CTA	TKUMD	TKUML	TKUMR	TKUMS/ST	TKUMCA/CTA
OA Height:	1600	1600	1600	1600	1600	1200	1200	1200	1200	1200
Seat Height:	480	480	480	480	480	480	480	480	480	480
OA Width:	980	890	890	800	1600	980	890	890	800	1600
OA Depth:	860	860	860	730	-	860	860	860	730	-

	TKUSD	TKUSL	TKUSR	TKU55	TKU58	TKU58T	TKU516	TKU516T
OA Height:	1200	1200	1200	450	450	350	450	350
Seat Height:	450	450	450	450	450	-	450	-
OA Width:	980	890	890	500	800	800	1600	1600
OA Depth:	860	860	860	500	500	500	500	500

### Take Up

	TKUFD	TKUFL	TKUFR	TKUFS/ST	TKUFCA/CTA
OA Height:	800	800	800	800	800
Seat Height:	480	480	480	480	480
OA Width:	980	890	890	800	1600
OA Depth:	860	860	860	730	-

# SEATING DIMENSIONS

## TECHNICAL INFORMATION

### Tamper Proof

	TPPBC	290
OA Height:	930 - 1090	910 - 1015
OA Width:	640	640
OA Depth:	640	640
OA Arm Height:	-	-
Seat Height:	450 - 560	480 - 585
Seat Width:	500	500
Seat Depth:	470	485

### Theia

	EI1 (SP/BP)	EIA (SP/BP)	EIART/LT (SP/BP)	EIH (SP/BP)	EIAH (SP/BP)	EIL (SP/BP)	EIAL (SP/BP)
OA Height:	815	815	815	1080	1080	980	980
OA Width:	540	570	570	540	570	540	540
OA Depth:	580	580	580	600	600	600	600
OA Arm Height:	-	655	655	-	925	-	825
Seat Height:	460	460	460	730	730	630	630

### Vona

	LS34A
OA Height:	840
OA Width:	580
OA Depth:	470
Seat Height:	420

### Zela Mesh

	ZLM	ZLMA	ZLMU	ZLMAU
OA Height:	800	800	800	800
OA Width:	565	625-705	565	625-705
OA Depth:	545	545	545	545
OA Arm Height:	-	685	-	685
Seat Height:	450	450	450	450
Seat Width:	450	450	470	470
Seat Depth:	410	410	420	420

### Zela Plastic Seat & Back

	ZL1	ZLA	ZLART/LT	ZL1SW	ZLASW	ZLARTSW(LT)
OA Height:	800	800	800	800	800	800
OA Width:	565	625 - 705	655 - 705	680	680 - 705	655 - 705
OA Depth:	545	545	545	680	680	680
OA Arm Height:	-	685	685	-	685	685
Seat Height:	450	450	450	450	450	450
Seat Width:	450	450	450	470	470	470
Seat Depth:	410	410	410	420	420	420

### Zela Upholstered Seat

	ZL1SP	ZLASP	ZLARTSP/LTSP	ZL1SPSW	ZLASPSW	ZLARTSPSW(LT)
OA Height:	800	800	800	800	800	800
OA Width:	565	655-705	655 - 705	680	680 - 705	680 - 705
OA Depth:	545	545	545	680	680	680
OA Arm Height:	-	685	685	-	685	685
Seat Height:	450	450	450	450	450	450
Seat Width:	470	470	470	470	470	470
Seat Depth:	420	420	420	420	420	420

### Zela Fully Upholstered

	ZL1BP	ZLABP	ZLARTBP/LTBP	ZL1BPSW	ZLABPSW	ZLARTBPSW(LT)
OA Height:	800	800	800	800	800	800
OA Width:	565	625 - 705	655 - 705	680	680 - 705	655 - 705
OA Depth:	545	545	545	680	680	680
OA Arm Height:	-	685	685	-	685	685
Seat Height:	450	450	450	450	450	450
Seat Width:	470	470	470	470	470	470
Seat Depth:	420	420	420	420	420	420

# SEATING DIMENSIONS

## TECHNICAL INFORMATION

### BAND 1

Agua	Task	CRIB 5	140,000 100% Polyester
Camira	Advantage	C&M	50,000 60% Polypropylene, 30% Wool, 10% Viscose
Camira	Cara	C&M	N/A 100% Polypropylene
Camira	Chateau	CRIB 5	30,000 100% Flame Retardant Polypropylene
Camira	Era	C&M	100,000 100% Polyester
Camira	Era 170	C&M	100,000 100% Polypropylene
Camira	Lucia	C&M	50,000 100% Post Consumer Recycled Polyester
Camira	Manhattan	C&M	50,000 100% Recycled Polyester
Camira	Phoenix	C&M	100,000 100% Polyester
Camira	Rivet	C&M	80,000 100% Repreve® Recycled Polyester (Plastic bottles)
Camira	X2	CRIB 5	100,000 100% Post Consumer Recycled Polyester
Camira	Xtreme	CRIB 5	100,000 100% Post Consumer Recycled Polyester
Chieftain	✓ Trimcell Classic	C&M	40,000 PVC / PES
Chieftain	✓ Trimcell Legend	C&M	40,000 PVC / PES
Gabriel	Event	C&M	100,000 100% Polyester
Gabriel	Fighter	C&M	130,000 100% Polyester
Gabriel	Medley	C&M	75,000 100% Polyester
Inloom	Alba	CRIB 5	100,000 100% Polyester
Inloom	Bondai	CRIB 5	150,000 100% Polyester
Inloom	Bondai 170	C&M	150,000 100% Polyester
Panaz	✓ Zest	CRIB 5	350,000 Coating: PVC/PU Blend, Backing: Viscose Polyester

### BAND 2

Agua	✓ Aries	CRIB 5	400,000 65% PVC, 35% Cotton
Agua	Buro	CRIB 5	100,000 100% Treated Polyester
Agua	Juno	CRIB 5	50,000 100% Treated Polyester
Agua	Kontor	CRIB 5	100,000 100% Treated Polyester
Agua	Lavoro	CRIB 5	100,000 100% Treated Polyester
Agua	Libra	CRIB 5	100,000 100% Treated Polyester
Agua	Linetta	CRIB 5	100,000 100% Treated Polyester
Agua	✓ Lunar	CRIB 5	400,000 2% Vinyl Acrylic, 78% PVC, 16% Polyester, 8% Cotton
Agua	✓ Paintpot	CRIB 5	400,000 2% Vinyl Acrylic, 71% PVC, 18% Polyester, 9% Cotton
Agua	✓ Stol	CRIB 5	400,000 2% Vinyl Acrylic 71% PVC, 18% Polyester, 9% Cotton
Camira	Aspect	CRIB 5	50,000 75% Trevira CS® FR Polyester, 25% Polyester
Camira	Canopy	C&M	60,000 100% Polyester
Camira	✓ Manila	CRIB 5	100,000 Surface: 100% PVC Substrate: 100% Cotton
Camira	Patina	CRIB 5	100,000 69% Wool, 18.5% Flax, 8% Polyamide, 4.5% Viscose
Camira	Quest	C&M	100,000 100% Post-Consumer Recycled Polyester
Camira	Sonus	C&M	N/A 72% Polyester, 18% Polyamide, 10% Viscose
Camira	Sprint	C&M	100,000 100% Polyester
Camira	Urban	CRIB 5	100,000 100% Post-Consumer Recycled Polyester
Camira	✓ Vita	CRIB 5	100,000 Surface: 98% PVC, 2% PU Substrate: 100% Cotton
Chieftain	✓ Carino	CRIB 5	500,000 Surface: Phthalate Free PVC Backing Organic Cotton/rPES
Chieftain	✓ Just Colour	CRIB 5	1,000,000 Phthalate Free PVC Backing Organic Cotton/rPES
Chieftain	✓ Just Pattern	CRIB 5	1,000,000 Phthalate Free PVC Backing Organic Cotton/rPES
Cheiftan	✓ Pasha	CRIB 5	400,000 Surface: Phthalate Free: 88% PVC, 12% PU Backing: 100% Recycled Cotton
Gabriel	Go Check	CRIB 5	80,000 100% Trevira CS
Gabriel	Go Couture	CRIB 5	80,000 100% Trevira CS
Gabriel	Go Uni	CRIB 5	100,000 100% Trevira CS
Gabriel	Luna 2	CRIB 5	70,000 90% New Zealand Wool, 10% Polyamide
Gabriel	Luna Fleur 2	C&M	50,000 90% New Zealand Wool, 10% Polyamide
Gabriel	Noma	CRIB 5	60,000 100% Post-Consumer Recycled Polyester
Gabriel	Repetto	C&M	100,000 100% Post Consumer Recycled Polyester
Inloom	Jet	CRIB 5	65,000 100% Trevira CS Polyester
Inloom	King Flex	CRIB 5	100,000 100% Trevira CS Polyester
Inloom	One	CRIB 5	100,000 100% Recycled Polyester
Inloom	Radio	CRIB 5	80,000 100% Polyester
Inloom	Time	C&M	100,000 100% Recycled Polyester
Panaz	Alba	CRIB 5	130,000 100% Polyester with FR Backcoating
Panaz	Altair	CRIB 5	60,000 100% Trevira CS
Panaz	✓ Aston	CRIB 5	750,000 Coating: PVC, PU blend, Basecloth: cotton, polyester
Panaz	✓ Brookland	CRIB 5	750,000 Coating: PVC, PU blend, Basecloth: cotton, polyester
Panaz	Highland	CRIB 5	70,000 100% Polyester with FR Backcoating
Panaz	Highland Matte	CRIB 5	90,000 Polyester/Elastine Blend with FR Backcoating
Panaz	Linear	CRIB 5	200,000 100% Polyester with FR Coating
Panaz	Luxe Performance Velvet	CRIB 5	70,000 100% Polyester with FR Coating
Panaz	Montagu	CRIB 5	50,000 100% Polyester with FR Coating
Panaz	✓ Morgan	CRIB 5	100,000 Coating: PVC/PU Blend, Backing: Viscose Polyester
Panaz	✓ Ultimate Touch	CRIB 5	100,000 Coating: PU, Basecloth: Cotton/Polyester
Panaz	Vespa	CRIB 5	45,000 Woven FR Coated Polyester Chenille
Panaz	✓ Vintage	CRIB 5	200,000 Coating: PVC, PU blend, Basecloth: cotton, polyester

# SELECTED BAND FABRICS

## TECHNICAL INFORMATION

### BAND 3

Agua	Aura	CRIB 5	100,000 100% Treated polyester
Agua	Cashmir	CRIB 5	100,000 100% Treated polyester
Agua	✓ Furnisof	CRIB 5	100,000 48% PU, 26% Cotton, 26% Polyester
Agua	✓ Fusion	CRIB 5	100,000 2% Vinyl Acrylic, 74% PVC, 16% Polyester, 8% Cotton
Agua	Oregon Hyde	CRIB 5	70,000 100% Treated Polyester
Agua	Nova	CRIB 5	80,000 100% Treated Polyester
Agua	Parody	CRIB 5	100,000 Denim: 70% PVC, 30% Cotton Weave: 2% PU, 74% PVC, 12% Cotton, 12% Polyester
Agua	Sark	CRIB 5	70,000 88% Treated Polyester, 12% Treated Nylon
Agua	Snowdon	CRIB 5	100,000 100% Treated Polyester
Agua	✓ Stretch	CRIB 5	400,000 2% Vinyl Acrylic, 78% PVC, 1% Elastane, 19% Polyester
Agua	Taurus	CRIB 5	50,000 67% Wool, 20% FR Viscose, 13% PES, 12% Cotton
Agua	Tones	CRIB 5	100,000 100% Treated Polyester
Camira	Halcyon Aspen	CRIB 5	50,000 100% Polyester with TriOnyx backcoat
Camira	Halcyon Blossom	CRIB 5	50,000 100% Polyester with TriOnyx backcoat
Camira	Halcyon Cedar	CRIB 5	60,000 100% Polyester with TriOnyx backcoat
Camira	Hi-Tech	C&M	60,000 60% Polypropylene, 29% Wool, 10% Viscose, 1% Carbon Fibre
Camira	Main Line Plus	CRIB 5	50,000 87% Wool, 20% FR Viscose, 13% Viscose
Camira	Main Line Twist	CRIB 5	50,000 75% Virgin Wool, 25% Flax
Camira	Nexus	C&M	100,000 100% Polyester
Camira	Oceanic	C&M*	100,000 100% Recycled Polyester, including 50% SEAQUAL yarn
Camira	Sumi	C&M*	200,000 90% Wool, 10% Polyamide
Camira	Synergy	C&M*	100,000 95% Virgin Wool, 5% Polyamide
Chieftain	Carousel	CRIB 5	200,000 59% Recycled Cotton, 41% Polyester
Chieftain	Lionella	CRIB 5	500,000 85% Phthalate Free PVC, 15% PU
Chieftain	✓ Ravel	CRIB 5	100,000 100% Polyester
Gabriel	Atlantic	C&M	110,000 100% polyester
Gabriel	Capture	C&M	200,000 85% New Zealand Wool, 15% polyamide
Gabriel	Europost 2	CRIB 5	50,000 100% New Zealand Wool
Gabriel	Gaja Classic	CRIB 5	50,000 100% New Zealand Wool
Gabriel	Step	CRIB 5	100,000 100% Trevira CS
Gabriel	Step Melange	CRIB 5	100,000 100% Trevira CS
Inloom	Jeans	CRIB 5	75,000 100% Trevira CS
Inloom	Jet	CRIB 5	65,000 100% Trevira CS Antimicrobial Polyester
Inloom	Milano	CRIB 5	80,000 100% Trevira CS Polyester
Inloom	Riva	CRIB 5	100,000 100% Trevira CS Polyester
Inloom	Roccia	CRIB 5	70,000 100% Trevira CS Polyester
Inloom	Sealife	C&M	100,000 Recycled Polyester - SEAQUAL Certified
Kvadrat	Field 2	CRIB 5	80,000 100% Trevira CS Polyester
Panaz	Allure	CRIB 5	70,000 100% FR Polyester
Panaz	Carnaby	CRIB 5	45,000 100% Polyester Chenille
Panaz	Coco	CRIB 5	60,000 100% Polyester with FR Back Coating
Panaz	Haven	CRIB 5	300,000 Polyester Viscose with PVC/PU coating
Panaz	Highland Stretch	CRIB 5	90,000 Polyester/Elastane Blend with FR coating
Panaz	Indulgence	CRIB 5	50,000 Trevira CS, FR Polyester Velvet
Panaz	Lush	CRIB 5	90,000 100% Polyester with FR Laminate
Panaz	Microvelle	CRIB 5	60,000 100% Polyester with Microporous Film and FR coating
Panaz	Sheema	CRIB 5	90,000 Coating: PVC, PU blend, Basecloth: Cotton, Polyester
Panaz	✓ Soft Touch	CRIB 5	100,000 Coating: PU, Cellulose, Basecloth: Cotton, Polyester
Panaz	✓ Stingray	CRIB 5	90,000 Coating: PVC, PU blend, Basecloth: Cotton, Polyester
Panaz	✓ Vyflex Plus	CRIB 5	100,000 Coating: PVC, PU, Basecloth: Cotton, Elastine
Panaz	✓ Woolton Downtown	CRIB 5	50,000 100% Polyester
Svensson	Tone	CRIB 5	50,000 100% Trevira CS Polyester
Svensson	Semi	CRIB 5	100,000 85% Wool, 15% Polyamide
Vescom	Cyprus	CRIB 5	300,000 Coating: Vinyl, Backing: Cotton/Polyester
Vescom	✓ Dalma	CRIB 5	300,000 Coating: Vinyl, Backing: Cotton/Polyester
Vescom	✓ Jemo	CRIB 5	300,000 Coating: Vinyl, Backing: Cotton/Polyester
Vescom	✓ Lani	CRIB 5	300,000 80% Wool, 20% Polyamide
Vescom	Leone Plus	CRIB 5	300,000 Coating: Vinyl, Backing: Cotton/Polyester
Vescom	✓ Malta	CRIB 5	300,000 Coating: Vinyl, Backing: Cotton/Polyester
Vescom	✓ Samar	CRIB 5	50,000 100% Flame Retardant Polyester

### BAND 4

Agua	Cord	CRIB 5	60,000 100% Treated Polyester
Agua	Finezza	CRIB 5	85,000 100% Treated Polyester
Agua	✓ Mystique	CRIB 5	100,000 1% PU, 64% PVC, 24% Polyester, 11% Cotton. Substrate: 50% PES, 50% Cotton
Agua	Pearl	CRIB 5	50,000 100% Treated Polyester
Agua	VerdEco	CRIB 5	90,000% Recycled Textiles
Agua	✓ The 7 Collection	C&M	100,000 2% Vinyl Acrylic, 80% PVC, 18% Polyester
Camira	24/7 Flax	CRIB 5	200,000 54% Polyamide, 35% Wool, 11% Flax
Camira	Aquarius	C&M*	50,000 100% Virgin Wool
Camira	Blazer	C&M*	50,000 100% Virgin Wool
Camira	Blazer Lite	C&M	N/A 100% Virgin Wool
Camira	Deca	CRIB 5	100,000 Surface: 100% PU, Substrate: 100% Cotton
Camira	Hemp Hebden	CRIB 5	50,000 60% Virgin Wool, 40% True Hemp
Camira	Intervene	CRIB 5	100,000 100% Post-Consumer Recycled Polyester with TriOnyx Backcoat
Camira	Kyoto	C&M*	200,000 90% Wool, 10% Polyamide
Camira	Landscape	C&M*	60,000 95% Virgin Wool, 5% Polyamide
Camira	Regent	C&M	50,000 100% FR Polyester
Camira	Silk	CRIB 5	50,000 70% Wool, 19% Flax, 11% Silk

# SELECTED BAND FABRICS

## TECHNICAL INFORMATION

Camira	Track	CRIB 5	80,000 100% Trevira CS® FR Polyester
Chieftain	Earthy	CRIB 5	100,000 75% Recycled Cotton, 25% Recycled Polyester
Crest	Vele	C&M	50,000 100% Bovine Leather
Gabriel	Breeze Fusion	CRIB 5	100,000 88% New Zealand Wool, 12% Polyamide
Gabriel	Crisp	C&M*	200,000 93% New Zealand Wool, 7% Polyamide
Gabriel	CrissCross	C&M*	110,000 89% New Zealand Wool, 11% Polyamide
Gabriel	Fame	CRIB 5	200,000 95% New Zealand Wool, 5% Polyamide
Gabriel	Fame Hybrid	C&M*	150,000 95% New Zealand Wool, 5% Polyamide
Gabriel	Luna 2	C&M*	70,000 90% New Zealand Wool, 10% Polyamide
Gabriel	Mood	C&M*	100,000 92% New Zealand Wool, 8% Polyamide
Inloom	Corte	CRIB 5	50,000 100% Trevira CS Polyester
Inloom	Spazio	C&M	50,000 100% Recycled Polyester
Kvadrat	Remix	C&M*	100,000 90% New wool (worsted), 10% Nylon
Kvadrat	Atlas	C&M*	100,000 90% New Wool (worsted), 10% Nylon
Kvadrat	Canvas 2	C&M*	100,000 90% New Wool (worsted), 10% Nylon
Kvadrat	Carla 2	C&M*	80,000 92% New Wool (worsted), 8% Nylon
Kvadrat	Remix 3	C&M*	100,000 90% New Wool (worsted), 10% Nylon
Panaz	Harvard	CRIB 5	130,000 100% Polyester with FR Backcoat
Svensson	Khaki	CRIB 5	50,000 100% Trevira CS (flame retardant)
Vescom	Furka Plus	CRIB 5	300,000 Vinyl Coat, Cotton/Polyester Backing

### BAND 5

Bute	Elgin	CRIB 5	175,000 92% Pure New Wool, 8% Nylon
Bute	Ramshead	CRIB 5	85,000 85% Pure New Wool, 15% Nylon
Bute	Troon	CRIB 5	95,000 92% Pure New Wool, 8% Nylon
Bute	Turnberry	CRIB 5	115,000 92% Pure New Wool, 8% Nylon
Camira	Craggan Flax	CRIB 5	50,000 85% Wool, 10% Flax, 5% Polyamide
Camira	Zap	C&M*	100,000 83% Virgin Wool, 17% Polyamide
Camira	Yoredale	C&M*	50,000 95% Wool, 3% Polyester, 2% Polyamide
Gabriel	Event	CRIB 5*	100,000 100% Polyester
Panaz	Enchant	CRIB 5	50,000 100% FR Polyester Velvet
Svensson	Step	CRIB 5	50,000 75% Wool, 25% Viscose
Vescom	Bowen	CRIB 5	100,000 92% Wool, 8% Polyamide
Vescom	Hestan	CRIB 5	60,000 100% Flame Retardant Polyester

### BAND 6

Camira	Synergy Quilt Channel	C&M	100,000 95% Virgin Wool, 5% Polyamide with Polyester and Polyurethane foam backing
Camira	Synergy Quilt Chevron	C&M	100,000 95% Virgin Wool, 5% Polyamide with Polyester and Polyurethane foam backing
Camira	Synergy Quilt Hourglass	C&M	100,000 95% Virgin Wool, 5% Polyamide with Polyester and Polyurethane foam backing
Bute	Alchemy	CRIB 5	80,000 94% Pure New Wool, 6% Nylon
Bute	Lewis	CRIB 5	55,000 100% Pure New Wool
Bute	Tweed	CRIB 5	80,000 94% Pure New Wool, 6% Nylon
Kvadrat	Recheck	C&M*	100,000 90% New Wool (Worsted), 10% Nylon
Moon	Basket	CRIB 5	40,000 100% Wool
Moon	Bibury	C&M*	40,000 100% Wool
Moon	Diamond	C&M*	32,000 100% Pure New Wool
Moon	Empire	C&M*	40,000 100% Wool
Moon	Herringbone	CRIB 5	40,000 100% Pure New Wool
Moon	Melton	C&M*	40,000 100% Pure New Wool
Moon	Parquet	C&M*	40,000 100% Pure New Wool
Moon	Sky	CRIB 5	40,000 100% Pure New Wool
Moon	Spectrum	CRIB 5	40,000 100% Pure New Wool
Moon	Thorpe	C&M*	34,500 100% Pure New Wool
Panaz	Corinthia	CRIB 5	100,000 Polyester/Viscose with FR Backcoating
Svensson	Accessoire	C&M	50,000 85% Wool, 15% polyamide
Svensson	Harper	CRIB 5	85,000 100% Trevira CS
Svensson	Heritage	C&M	45,000 90% Wool, 10% Polyamide
Svensson	Ink	CRIB 5	60,000 85% Wool, 15% Polyamide

### BAND 7

Bute	Melrose	CRIB 5	85,000 93% Pure New Wool, 7% Nylon
Gabriel	Select	C&M*	200,000 85% New Zealand Wool, 15% Polyamide
Kvadrat	Clara	C&M*	80,000 92% New wool (Worsted), 8% Nylon
Kvadrat	Fiord 2	C&M*	60,000 92% New Wool (Worsted), 8% Nylon
Kvadrat	Melange Nap	C&M*	60,000 97% New Wool (Worsted), 3% Nylon
Kvadrat	Steelcut Trio 3	C&M*	100,000 90% New Wool (Worsted), 10% Nylon
Kvadrat	Tonica 2	C&M*	45,000 100% New Wool
Svensson	Mingel	CRIB 5	50,000 100% Trevira CS
Svensson	Poppy	CRIB 5	50,000 100% Trevira CS
Svensson	Velvet	CRIB 5	40,000 100% Trevira CS
Vescom	Hestan	CRIB 5	60,000 100% Flame Retardant Polyester
Vescom	Lindau	C&M*	100,000 80% Wool, 20% Polyamide



### LEATHER GROUP 1

---

Crest / JMT Shelly

Leather Group 1 is for selected Shelly hides. Other colours from this range are available but could be subject to a surcharge dependant on leather maximisation, POA. Please note that all leathers are subject to natural markings and variations in shade. These natural bruise marks distinguish it from man made imitations. The variations are features, not faults.



### OTHER INFORMATION

---

#### Fire Retardancy

All information regarding fire retardancy has been provided by the fabric manufacturer.

#### Flame Retardancy Ratings:

C&M            Cigarette and Match = Low Hazard  
C&M\*        Cigarette & Match as standard. Can be treated to achieve Crib 5 upon request.  
CRIB 5        Medium Hazard  
CRIB 5\*      Medium Hazard when used over CMHR 50kg Foam.

#### Abrasion

All information regarding abrasion has been provided by the fabric manufacturer and communicates wear resistance as determined by the Martindale abrasion test.

#### Vinyl

Fabrics marked with  are Vinyl.

Product leadtimes may be affected by the fabric selected. Please contact our Sales Department for further information.

#### Please Note:

Fabrics other than those listed above are available. These fabrics may require testing to ensure their suitability for use on the intended product. Not all fabrics shown are suitable for use across all ranges within this document. Due to their specification, certain fabrics may have a detrimental effect on the final appearance of a product.

# SELECTED BAND FABRICS

## TECHNICAL INFORMATION

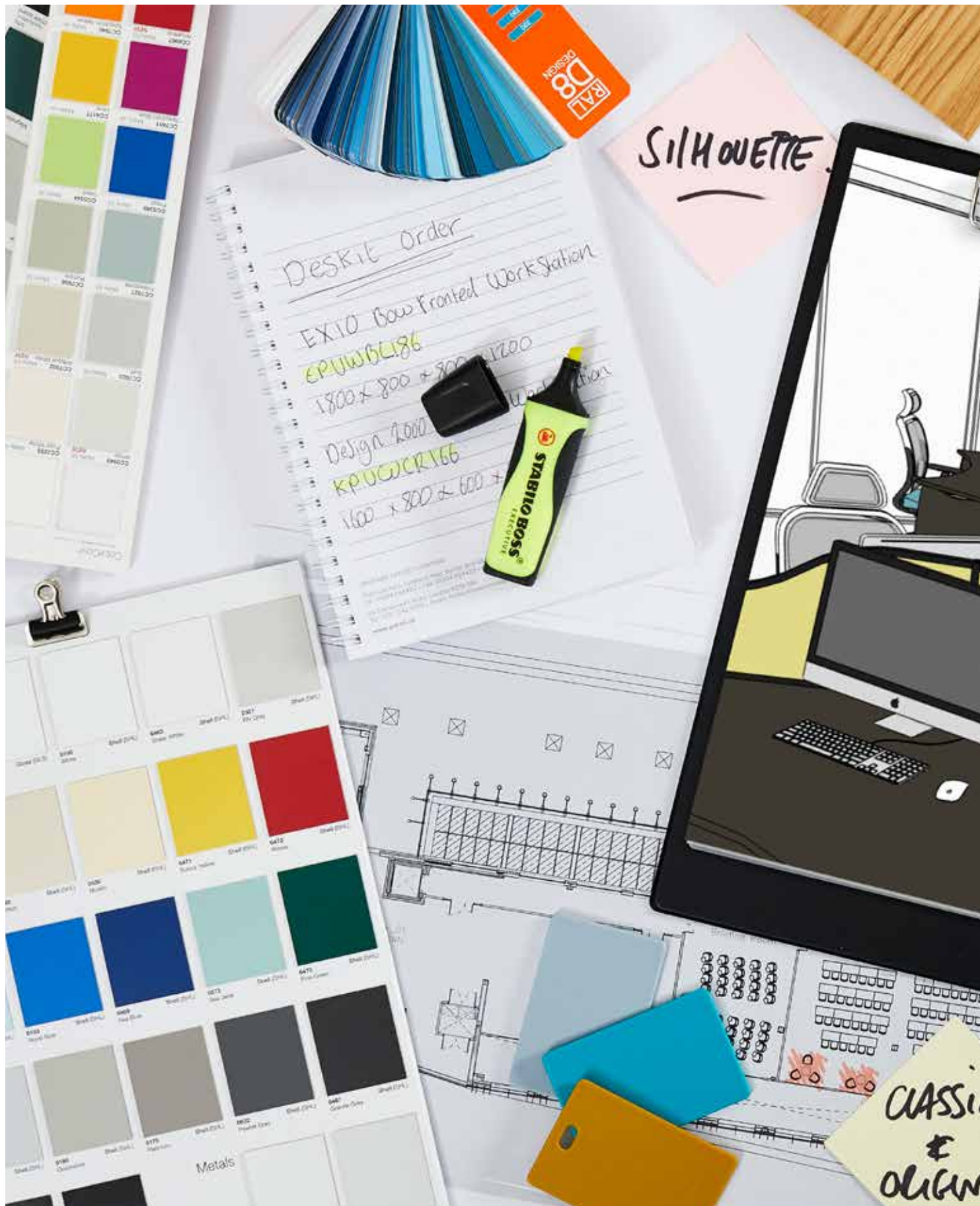

SELECTED BAND FABRICS  
TECHNICAL INFORMATION

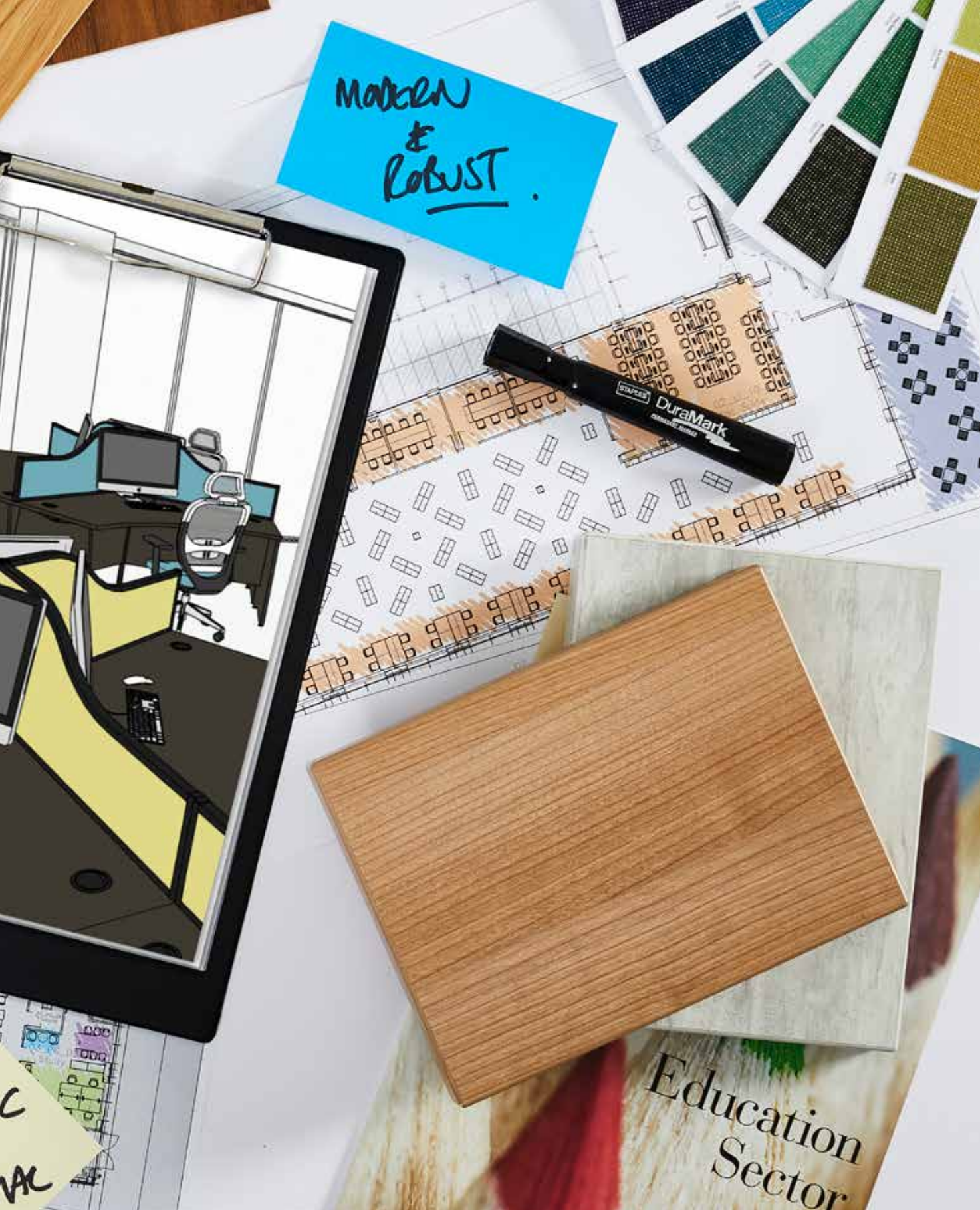

# WOOD, METAL & LAMINATE FINISHES

## TECHNICAL INFORMATION

### GRESHAM MFC COLLECTION

A chic choice of 13 classic wood grain finishes and 5 fashionable yet subtle colours. Match or complement your chosen MFC with environmentally friendly, superior high impact resistant ABS edging.

**Please Note: There is a Surcharge on Adlington Oak and Dark Concrete**



### THE PASTEL MFC COLLECTION

Accent Colours for Doors and Drawer Fronts only.

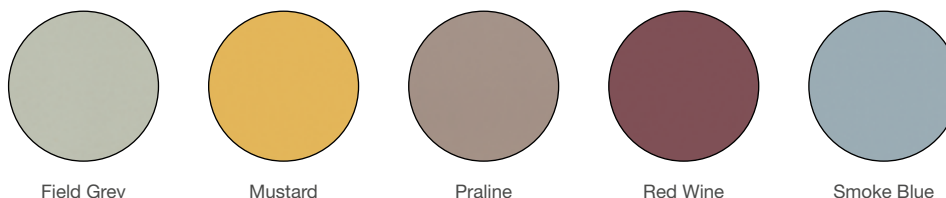

### METAL FINISHES

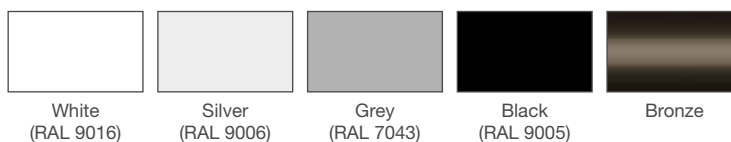

### PASTEL METAL FINISHES

£26 Surcharge applicable on all Pastel Metal Finishes

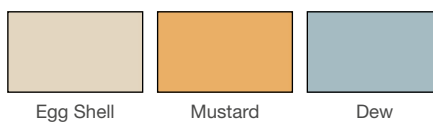

# WOOD, METAL & LAMINATE FINISHES

## TECHNICAL INFORMATION

### THE KIKO COLLECTION

A deluxe selection of plain colours, wood grain effect High Pressure Laminate finishes.  
Match or complement your chosen Laminate with environmentally friendly, superior high impact resistant ABS edging.



### Adlington Oak MFC



# WOOD, METAL & LAMINATE FINISHES

## TECHNICAL INFORMATION



### THE HALO COLLECTION

120 Plain Colours answering key interior trends for new blues, pastels and nature inspired eco palettes.  
We have a large selection of matching Edging to choose from that perfectly complements our Halo Collection.

F0949 White	F2696 Super White	F2255 Polar White	F1093 Aries	F7934 Pearl	F2001 Baikal	F3091 Crystal White	F2274 Blanc Polaire	F2010 Malibu
F7927 Folkestone	F7923 Surf	F2791 Silver	F7938 Glacier	F1484 Steel	F1994 Fox	F7961 Fog	F7902 Iron	F7858 Pumice
F0189 Sparta	F7924 Lead	F1535 Tornado	F7928 Mouse	F2770 Sarum Grey	F3202 Otter	F7912 Storm	F2297 Terril	F7837 Graphite
F2253 Diamond Black	F9266 Citadel	F5342 Earth	F7949 Soft White	F1534 Magnolia	F1192 Porcelana	F1040 Alpino	F7932 Antique White	F2273 Seringa
F1531 Irish Cream	F2774 New Magnolia	F0547 Papyrus	F2296 Snow White	F0901 Gobi	F2833 Sandstone	F3050 Cygnet	F7929 Oyster Grey	F1532 Eldorado
F7882 Pale Gold	F7940 Spectrum Yellow	F1803 Tenere	F8751 Mojave	F0187 Kashmir	F0903 Cafe	F1485 Chrome Yellow	F3209 Sol	F4156 Caramel
F8757 Choco	F2200 Dark Chocolate	F8823 Patina	F8857 Just Gold	F4155 Sun	F4161 Terracotta	F3210 Levante	F5348 Energy	F8858 Just Rose





# WOOD, METAL & LAMINATE FINISHES

## TECHNICAL INFORMATION

### THE HALO COLLECTION CONTINUED

120 Plain Colours answering key interior trends for new blues, pastels and nature inspired eco palettes.  
We have a large selection of matching Edging to choose from that perfectly complements our Halo Collection.

F2582 Lilac	F0231 Peaceful Blue	F1194 Iris	F2962 Clementine	F1238 Carnaval	F0232 Juicy Pink	F1019 Azur	F7880 Thistle	F2824 Blaze Red
F7845 Spectrum Red	F6907 Amarena	F5346 Orchid	F4168 Campanula	F1997 Oceano	F6902 Grenadine	F0188 Beaujolais	F5345 Viola	F2483 Ultramarine
F7851 Spectrum Blue	F2828 Tropical Blue	F2005 Paprika	F7966 New Burgundy	F6903 Cassis	F7969 Navy Blue	F7914 Marine Blue	F8821 Just Blue	F5493 Arctic Blue
F5494 Aquamarine	F5127 Monaco	F2966 Opal	F3236 Avocado	F5344 Seed	F1998 Oslo	F1850 Fontana	F5349 Fossil	F8755 Lemon
F0800 Artichoke	F7884 China Blue	F5347 Maui	F7879 Dusty Jade	F7853 Ocean Grey	F4177 Lime	F5341 Wasabi	F8822 Denim	F4172 Caribbean
F1326 Capri	F7897 Spectrum Green	F6901 Vibrant Green	F3007 Pale Olive	F0157 Tahiti	F7846 Grotto	F2478 Bermuda	F7967 Hunter Green	F8820 Leaf Green
F5343 Possum	F0233 Heather	F5323 Nocturne						



### THE FENIX COLLECTION

Fenix, the nanotechnological material from Arpa Industriale, has revolutionised the world of interior design. It is not only beautiful to look at but, most importantly, it is also a high-tech material, made unique by its characteristics.

Fenix has these characteristics by undergoing a particular series of processes, including a multilayer coating and the use of next-generation nanoparticles and acrylic resins, which are hardened and cured through an innovative Electron Beam Curing process. This process makes the material anti-fingerprint, soft to the touch, opaque and extremely durable, so much so that it can withstand serious knocks and scratches, but also makes it highly resistant to the aggressive action of solvents and reagents typically used for household cleaning.

Fenix is also heat-resistant. Additionally, should the surface have superficial microscratches, heat actually helps to repair them. The surface of the material is scattered with a dense grid of crosspolymers with their own memory, which can be reactivated by the application of heat.

Fenix is also water-repellent, hygienic, thanks to its effective bacteria-killing action, and resistant to mould. All of these make it a perfect surface for contact with food and very easy to clean.

We have a large selection of matching Edging to choose from that perfectly complements our Fenix Collection.





# WOOD, METAL & LAMINATE FINISHES

## TECHNICAL INFORMATION

### FURNITURE LINOLEUM – DESKTOP

The Furniture Linoleum Desktop collection consists of 21 elegant colours that add a distinctive touch to any piece of furniture.







## FIND US ON SOCIAL MEDIA



FACEBOOK

---

Gresham Office Furniture

---

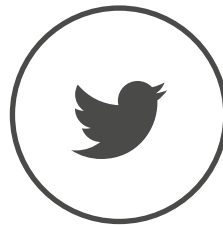

TWITTER

---

@greshamltd

---

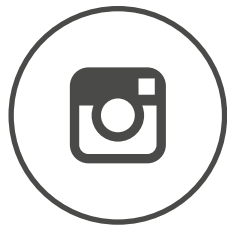

INSTAGRAM

---

GreshamOfficeFurniture

---



LINKEDIN

---

linkedin@gof.co.uk

---



We've come a long way since

1976

and we're not done yet

Gresham Office Furniture Limited Registered in England No 1284733

Head Office Platinum Park | Lynstock Way | Horwich | Bolton | BL6 4SA

Tel: 01204 664422 | Fax: 01204 664433 | Email: [info@gof.co.uk](mailto:info@gof.co.uk)

London Showroom 28 St John's Lane, Clerkenwell | London | EC1M 4BU

Tel: 020 7253 2054 | Email: [londonshowroom@gof.co.uk](mailto:londonshowroom@gof.co.uk)

[www.gof.co.uk](http://www.gof.co.uk)